

Part Number: PT318-34221
PT318-34221-SB
PT318-34221-LB

Kit Contents

Item #	Quantity Reqd.	Description
1	1	Bed Mat

Hardware Bag Contents

Item #	Quantity Reqd.	Description

Additional Items Required For Installation

Item #	Quantity Reqd.	Description

Conflicts

Tonneau Cover

Recommended Tools

Personal & Vehicle Protection	Notes
Special Tools	Notes
Installation Tools	Notes
Special Chemicals	Notes

General Applicability

MY22 and newer Tundra models

Recommended Sequence of Application







Item #	Accessory

*Mandatory

Vehicle Service Parts (may be required for reassembly)

Item #	Quantity Reqd.	Description

Legend

	STOP: Damage to the vehicle may occur. Do not proceed until process has been complied with.
	OPERATOR SAFETY: Use caution to avoid risk of injury.
	CAUTION: A process that must be carefully observed in order to reduce the risk of damage to the accessory/vehicle and to ensure a quality installation.
	TOOLS & EQUIPMENT: Used in Figures calls out the specific tools and equipment recommended for this process.
	REVISION MARK: This mark highlights a change in installation with respect to previous issue.
	SAFETY TORQUE: This mark indicates that torque is related to safety.
	REGULATORY MARK: This mark indicates the component is related to regulatory compliance

Procedure

Care must be taken when installing this accessory to ensure damage does not occur to the vehicle. The installation of this accessory should follow approved guidelines to ensure a quality installation.

These guidelines can be found in the "Accessory Installation Practices" document.

This document covers such items as:-

- Vehicle Protection (use of covers and blankets, cleaning chemicals, etc.).
- Safety (eye protection, rechecking torque procedure, etc.).
- Vehicle Disassembly/Reassembly (panel removal, part storage, etc.).
- Electrical Component Disassembly/Reassembly (battery disconnection, connector removal, etc.).

Please see your Toyota dealer for a copy of this document.

1. Prepare for Installation

- (a) Open package and check for part damage.

2. Install the Bed Mat

- (a) Place Bed Mat in truck bed with logo towards the rear of the vehicle and facing up (Fig. 2-1).
- (b) Position the Bed Mat so it is centered around the wheel wells.

3. Complete the Installation

- (a) Close the tailgate.

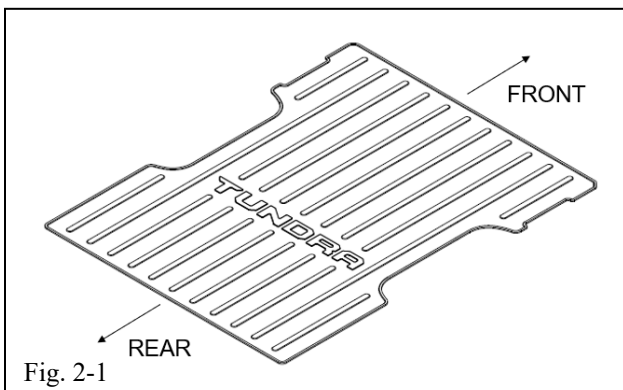

Checklist - these points **MUST** be checked to ensure a quality installation.

<u>Check:</u>	<u>Look For:</u>
<p><u>Accessory Function Checks</u></p> <ul style="list-style-type: none"><input type="checkbox"/> Correct part number has been installed<input type="checkbox"/><input type="checkbox"/><input type="checkbox"/>	<p>Verify part number on package</p>
<p><u>Vehicle Function Checks</u></p> <ul style="list-style-type: none"><input type="checkbox"/><input type="checkbox"/>	
<p><u>Vehicle Appearance Check</u></p> <ul style="list-style-type: none"><input type="checkbox"/> After accessory installation and removal of protective cover(s), perform a visual inspection.	<p>Ensure no damage (including scuffs and scratches) was caused during the installation process. (For PPO installations, refer to TMNA Accessory Quality Shipping Standard.)</p>