

Part Number **PTS21-52063**

NOTE: Part number of this accessory may not be the same as the part number shown.

Kit Contents

Item #	Quantity Reqd.	Description
1	1	Front Left Door Sill Protector
2	1	Front Right Door Sill Protector
3	2	Rear Door Sill Protector
4	1	Instruction Sheet

Vehicle Service Parts (may be required for reassembly)

Item #	Quantity Reqd.	Description
1		
2		
3		

Hardware Bag Contents

Item #	Quantity Reqd.	Description

Additional Items Required For Installation

Item #	Quantity Reqd.	Description

Conflicts

--

Recommended Tools

Personal & Vehicle Protection	Notes
None	
Special Tools	Notes
Surface Thermometer	Infrared Non-contact
Installation Tools	Notes
Wiping Cloths	Non-scratch, Lint Free
Heat Gun	Master Heat Gun HG-301A or equivalent
Special Chemicals	Notes
Cleaner	3M™ Prepsolvent-70

General Applicability





Note: 2007 Yaris Sedan

Recommended Sequence of Application

Item #	Accessory
1	
2	
3	

*Mandatory

Legend

	STOP: Damage to the vehicle may occur. Do not proceed until process has been complied with.
	OPERATOR SAFETY: Use caution to avoid risk of injury.
	CAUTION: A process that must be carefully observed in order to reduce the risk of damage to the accessory/vehicle and to ensure a quality installation.
	TOOLS & EQUIPMENT: Used in Figures calls out the specific tools and equipment recommended for this process.

Care must be taken when installing this accessory to ensure damage does not occur to the vehicle. The installation of this accessory should follow approved guidelines to ensure a quality installation.

These guidelines can be found in the "Accessory Installation Practices" document.

This document covers such items as:-

- Vehicle Protection (use of covers and blankets, cleaning chemicals, etc.).
- Safety (eye protection, rechecking torque procedure, etc.).
- Vehicle Disassembly/Reassembly (panel removal, part storage, etc.).
- Electrical Component Disassembly/Reassembly (battery disconnection, connector removal, etc.).

Please see your Toyota dealer for a copy of this document.

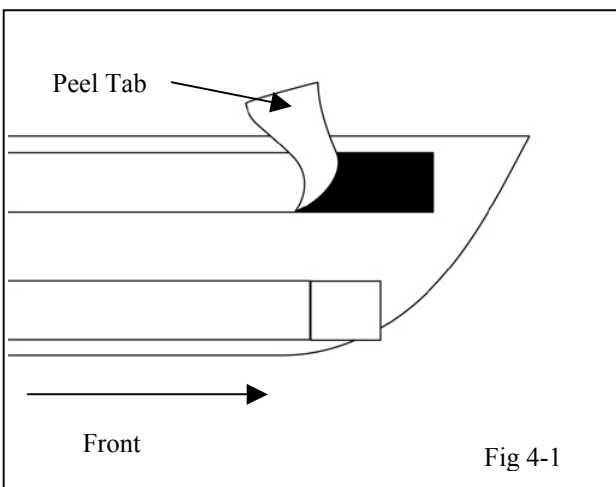
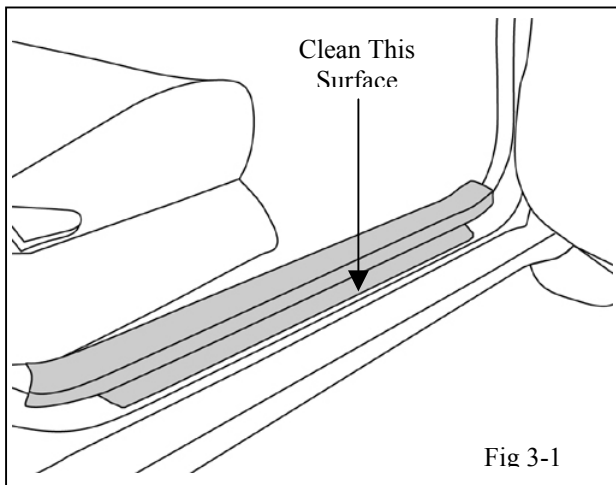

1. Check Kit Contents



- (a) Check kit for content and damage.

2. Installation Temperature



- (a) The Door Sill Protector and Sill surface temperature must be between 60° F and 90° F at time of actual installation.

- (b) If necessary, a heat gun can be used to heat the part and surface to correct installation temperature.

3. Clean the Door Sill Surfaces



- (a) Clean the plastic sill surface using cleaner specified on Page 1. Dry surface with a clean, non-scratch cloth. (Fig. 3-1)

- (b) Surface must be free from all contaminants (plastic protectants, oily - substances, dirt, etc.)

4. Installation of Door Sill Protectors

- (a) The label on the back of part identifies the applicable side of the vehicle and must be oriented towards the front of the vehicle.

- (b) Using the pull tabs, remove the tape liner. (Fig. 4-1)



- (1) Avoid Finger contact with the adhesive surface.

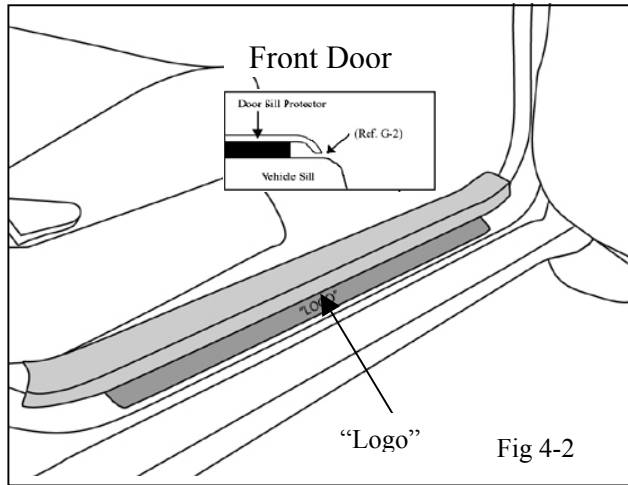

Fig 4-2

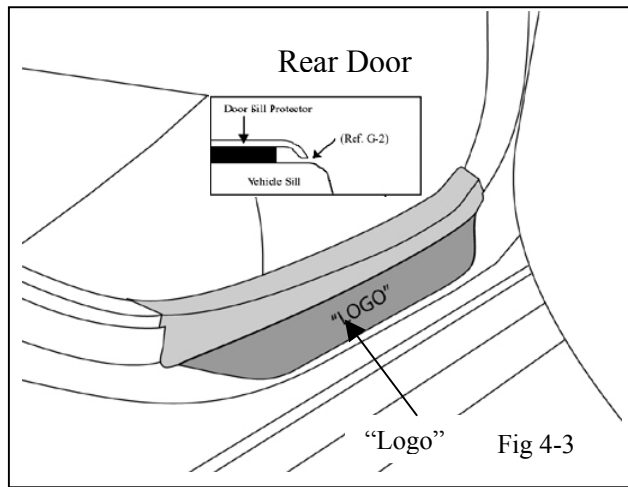

Fig 4-3

- (c) Make sure the door sill protector is in the proper orientation before the adhesive contacts the door sill.
- (d) Front / Rear - The vehicle name "Logo" must be right reading from outside the vehicle. (Figs 4-2 & 4.3)
- (e) Align the turned down edges of the door sill protector with the edges of the factory sill plate.
- (f) Use light finger pressure to initially adhere the door sill protector adhesive to the door sill.
 - (1) If necessary, the part can still be repositioned at this time.
- (g) Once satisfactory positioning has been achieved, use fingertips and the palm of your hand to gain full tape adhesion.
 - (1) Use firm, even pressure.
 - (2) The bottom edge of door sill protector should not contact the vehicle. (Inset in Figs 4-2 & 4-3)

TOYOTA YARIS SEDAN 2007 - DOOR SILL PROTECTOR
Checklist - these points MUST be checked to ensure a quality installation.

Check:

Look For:

Accessory Function Checks

- Correct part number has been installed.
- The turn down edges of the door sill protector are aligned with the edges of the factory sill plate.

Verify part number on package.

Look for loose edges and proper alignment.