

Part Number: PTR56-21110

Kit Contents

Item #	Quantity Req'd.	Description
1	4 per vehicle	Al Wheel, Silver 19x8.0x35mm

Hardware Bag Contents

Item #	Quantity Req'd.	Description
1	1 per wheel	TRD Center Cap P/N PTR56-21111

Additional Items Required For Installation

Item #	Quantity Req'd.	Description
1	1 per wheel set or 1 per vehicle	Lugnut Set w/ Spline Tool & 4 Wheel Locks & Key Tool P/N PTR27-52081 (Required & Sold Separately)
2	1 per wheel	Tire: Toyo Proxes 4 235/35ZR19 91W M + S (Recommended)
3	As Required	Balance Weights Lo-Profile Stick-on Type 3M TN-2023 or equivalent.
4	As Required	TPMS 20 degree angle Single DIO P/N 42607-33011
5	1	Tire Pressure Label MDC P/N 00602-21011
6	1	Owners Manual Label MDC P/N 00602-35061
7	1 PPO DIO	Wheel Lock Pouch PT276-06999 00602-06999 (from the MDC)

Conflicts

--

Recommended Tools

Personal & Vehicle Protection	Notes
Safety Glasses	
Seat Protection	Blanket
Special Tools	Notes
Tire Changing Machine	Hunter TC3200, or Corgi Artiglio Master 26 or equivalent.
Wheel Balancing Machine	Hunter GSP9700, or equivalent.
Centering Cone	Hunter BACK-SIDE collet 192-52-2 or equiv.
Wing Nut	Hunter 76-371-3 or equiv.
4.5 inch Cup w/ Sleeve	Hunter 175-353-1 or equiv.
4.5 inch protector Sleeve	Hunter 106-82-2 or equiv.
Foot Brake Application Tool	Snap-on B240A Pedal Jack or equivalent.
Toyota Diagnostic Tester or Techstream Device	Software Version 13.2a or newer required.

Issue: A 08/19/2010

NOTE: Part number of this accessory may not be the same as the part number shown

Installation Tools	Notes
Lug Nut Wrench	21 mm wrench flat
Rubber Mallet	
Torque Wrench	20-150 ft-lbf (27-204 N-m)
Torque Wrench	30-150 in-lbf (3.3-17 N-m)
Sockets	11mm and 21 mm Deep Well, Thin Wall
4 inch extension	For TPMS torque wrench
Valve Stem Torque Tool	Snap-On QDTPMS or equiv.

Clean Lint-free Cloth	
Nylon Panel Removal Tool	e.g. Panel Pry Tool #1 Toyota SST # 00002-06001-01
Valve Stem Removal Tool	Schraeder Valve Type
Wire Brush	Hand held size
Special Chemicals	Notes
Tire Lube	Myers or equivalent
Cleaner (for rework of stick on weights if needed)	PPO/DIO: locally approved cleaner, e.g. No stronger than a 50-50 mix of Simple Green and Water.

General Applicability

Applicable to 2011+ Scion tC with TPMS. Use with tire size 235/35ZR19 91W M+S







Recommended Sequence of Application

Item #	Accessory
1	TRD 19" Alloy Wheel & 19" Tire
2	Wheel Lugs/Locks, PPO/DIO PN PTR27-52081
3	Wheel Lock Vinyl Pouch PT276-06999

Vehicle Service Parts (May be required for reassembly)

Item #	Quantity Req'd.	Description
1	0 – 4 as needed	Valve Stem Grommet Fitting Kit (if required) P/N 04423-0E010
2	0 – 4 as needed	TPMS 20 degree angle Single DIO P/N 42607-33011

Legend

	STOP: Damage to the vehicle may occur. Do not proceed until process has been complied with.
	OPERATOR SAFETY: Use caution to avoid risk of injury.
	CAUTION: A process that must be carefully observed in order to reduce the risk of damage to the accessory/vehicle and to ensure a quality installation.
	TOOLS & EQUIPMENT: Used in Figures calls out the specific tools and equipment recommended for this process.
	REVISION MARK: This mark highlights a change in installation with respect to previous issue.
	SAFETY TORQUE: This mark indicates that torque is related to safety.

Care must be taken when installing this accessory to ensure damage does not occur to the vehicle. The installation of this accessory should follow approved guidelines to ensure a quality installation.

These guidelines can be found in the "Accessory Installation Practices" document.

This document covers such items as:-

- Vehicle Protection (use of covers and blankets, cleaning chemicals, etc.).
- Safety (eye protection, rechecking torque procedure, etc.).
- Vehicle Disassembly/Reassembly (panel removal, part storage, etc.).
- Electrical Component Disassembly/Reassembly (battery disconnection, connector removal, etc.).

Please see your local dealer for a copy of this document.

1. Vehicle Preparation.



(a) Firmly apply parking brake.



(b) Put automatic transmission in "P".

(Fig. 1-1).

Put manual transmission in "R".

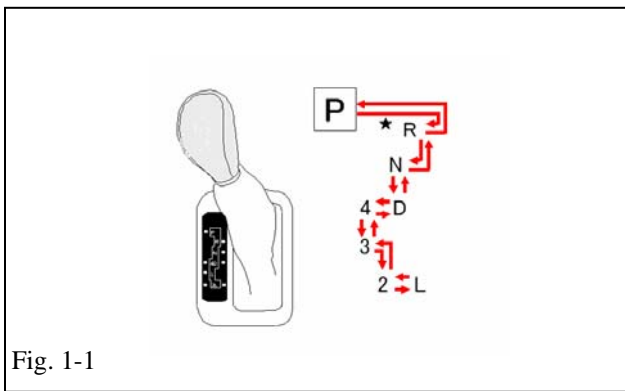

Fig. 1-1

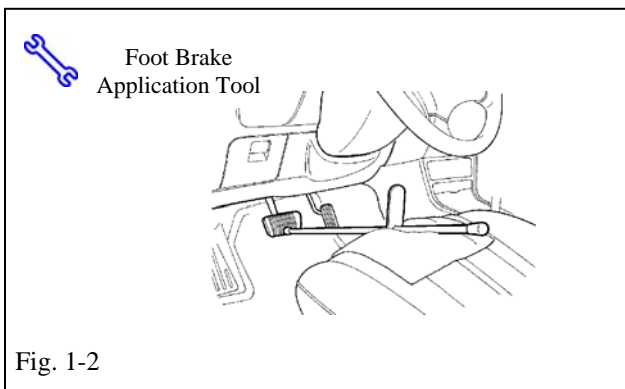

Fig. 1-2

(c) Add seat protection (blanket) and apply foot brake using foot brake application tool as needed.

(Fig. 1-2).

(d) Lift vehicle.

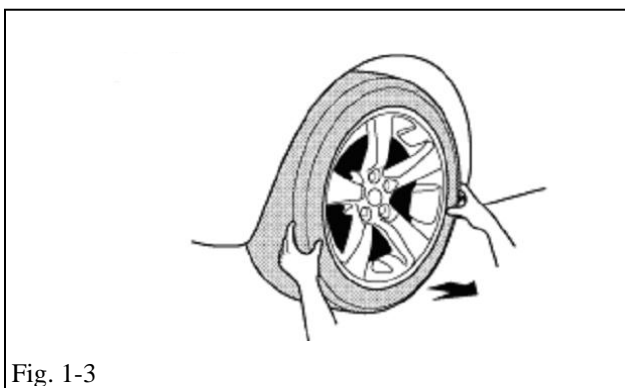
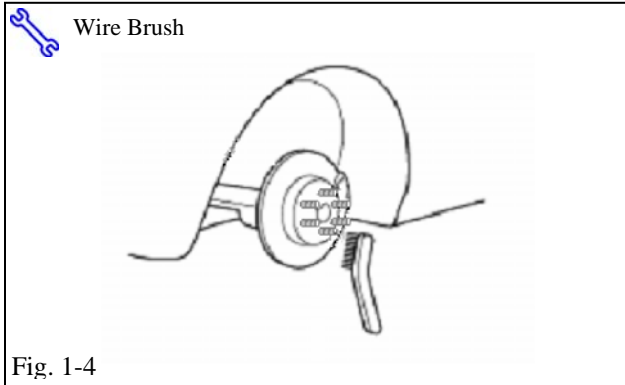

Fig. 1-3



(e) Remove OE wheel and tire assembly from vehicle (Fig. 1-3). Wear safety glasses while removing wheels.



+ (f) If required, remove any corrosion on the mounting surface of the vehicle with a wire brush. Wear safety glasses to protect against any debris. (Fig. 1-4).

2. Remove Tire Pressure Monitor Valve Sub-assembly.

! **NOTE: 20 degree Tire Pressure Sensors MUST stay with same vehicle!**

40 degree sensors are NOT re-used on ANY Accessory Alloy Wheels! (Fig. 2-1)

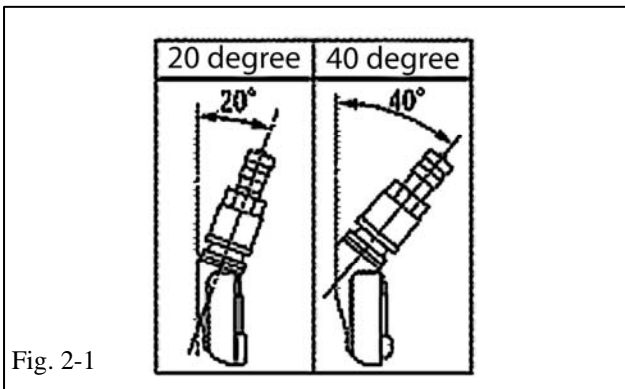

- (a) Remove the valve stem cores and release pressure from the tires.
- (b) Remove the nuts and washers and let the pressure sensors drop inside the tires.
- (c) Carefully separate the upper tire bead from the wheel rim. (Fig. 2-2).

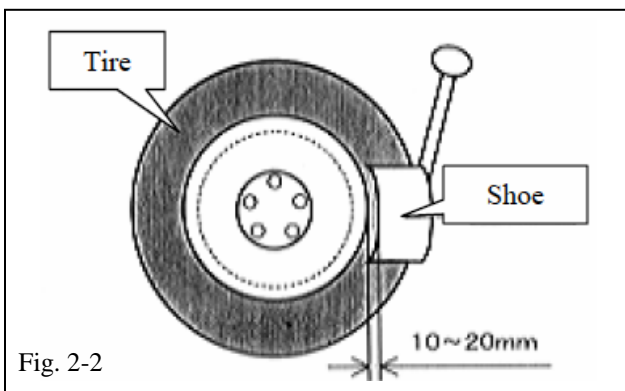

STOP **NOTE:** Be careful not to damage the tire pressure monitor due to interference between the sensor and tire bead.

- (d) Remove the sensor from the tire and remove the bead on the lower side as in the usual tire removal operation.
- (e) Dismount OE tire from the OE wheel.
- (f) Repeat for all 4 tires.

3. Install Tire Pressure Monitor Sensor (TPMS) Sub-assembly into TRD Accessory Wheels.

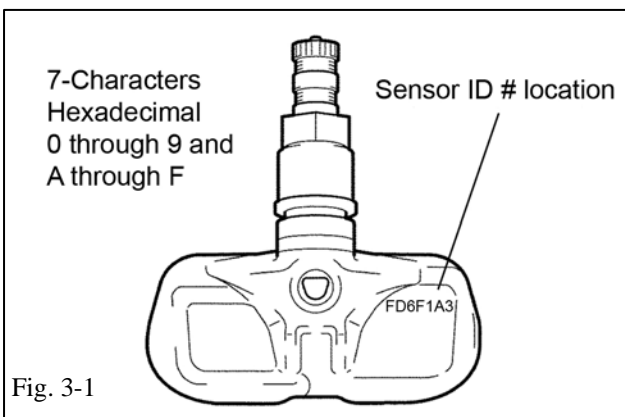

- (a) If previously removed sensor is 20 degree sensor, proceed to step 3 (c). If previously removed sensor is 40 degree sensor, you must install new 20 degree sensors into accessory wheels. When installing new 20 degree sensors, you **MUST** record sensor ID codes for all 4 wheels and register these 4 new ID codes (Fig. 3-1) with the vehicle ECU. Each sensor has a unique

sensor ID code. The sensor ID code is an 7-character hexadecimal string comprised of numbers 0 through 9 and letters A through F. See Fig 3-1 for example code and location.



(b) **IMPORTANT!** Record all four new TPMS ID codes onto a sheet of paper or in a shop notebook. These **MUST** be programmed into the vehicle ECU later in step **10**.

(c) Check that the wheel valve hole is clean and free of sharp edges or burrs.

(d) Visually check that there is no deformation or damage on the tire pressure monitor valve sub-assembly. Check that the grommet, washer, and nut are all clean and good.



NOTE: Change grommet to a new one ONLY IF the grommet is or was damaged. A damaged grommet is **NOT** re-usable.

(e) Insert the tire pressure monitor valve sub-assembly into the wheel valve hole from the inside of the rim and bring the valve stem to the outside. (Fig. 3-2).

(f) Insert the tire pressure monitor valve sub-assembly so that the sensor ID number and text is visible. See Fig. 3-1 & 3-2.



NOTE: Incorrect orientation of pressure monitor sub-assembly may cause damage and prevent signal transmission during high-speed running.



(g) Install the washer on the outside of the wheel and secure with the nut.



Tighten the nut to **36 in-lbf** (4.0 N-m).

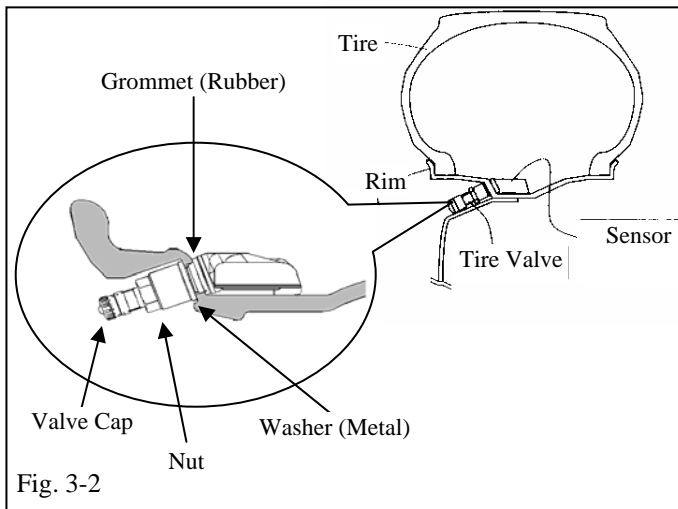

4. Tire Mounting.

⚠ IMPORTANT: Toyo Proxes 4 Tires are DIRECTIONAL! You must mount **2 LEFTS** and **2 RIGHTS** per vehicle. Direction is indicated on the tire sidewall.

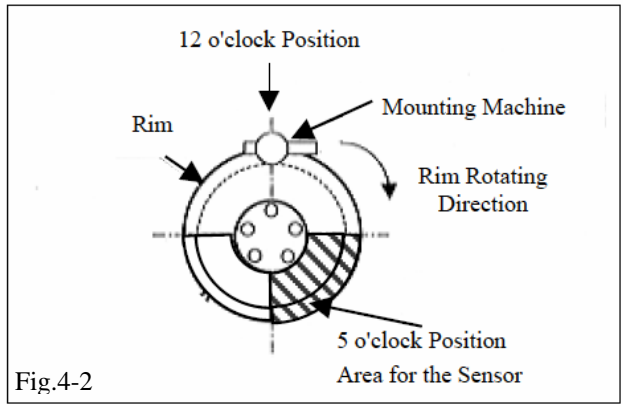
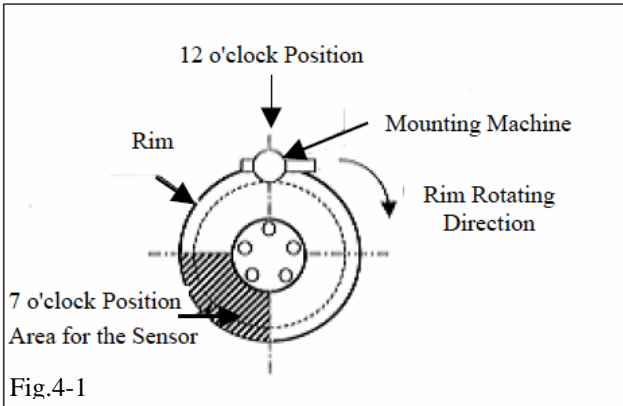

- (a) Use tire lube on tire beads, and bead locations on wheel, prior to mounting the tire.
- (b) Position the wheel on the mounting machine with the sensor at ~ 7 o'clock position (shaded area in Fig. 4-1)

(1) Mount/dismount head is considered as 12 o'clock Position.

- (c) Mount the lower tire bead.

STOP NOTE: If the sensor is positioned outside this area, it may generate interference with the tire bead, possibly causing damage to the sensor.

- (d) Re-position the wheel on the mounting machine with the sensor at ~ 5 o'clock position (shaded area in Fig. 4-2)

- (e) Mount upper tire bead.

STOP NOTE: Make sure that the tire bead and tool does not interfere with the main body of the sensor and the bead does not clamp sensor.

- +** (f) To seat tire beads, inflate tire beyond 35 PSI but not more the than the maximum tire bead seat pressure indicated on the tire sidewall. If it is not indicated use 40 PSI as a limit. If tire bead is not seated when pressure registers 40 PSI, deflate the tire and re-inflate to seat the beads. Install and torque the valve stem cores with the valve stem torque tool. Regulate tire pressure to:

FRONT: **39 PSI** (270 kPa) REAR:
36 PSI (250 kPa)

⚠ Remove tire labels from tire tread prior to balancing. Be sure to Re-Check torque on TPMS nuts, and install valve stem caps.

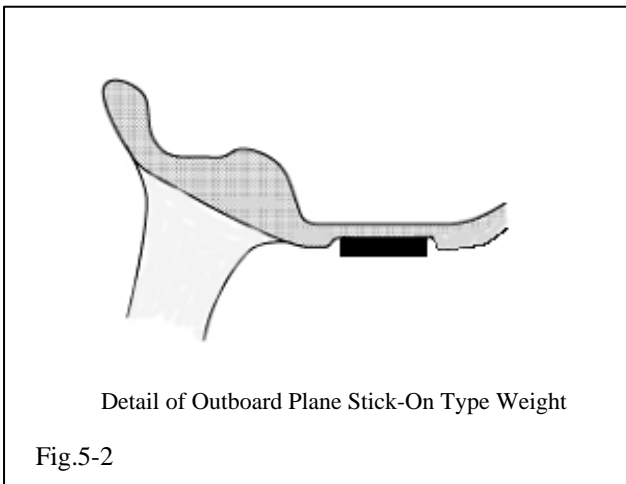
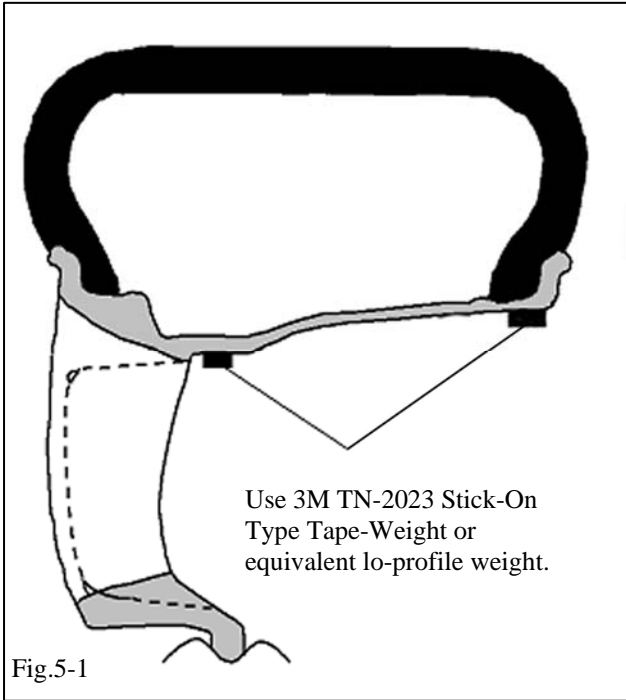

5. Wheel Balancing.



NOTE: Application temperature for stick-on type weight is above 50°F (10°C). Weights should be no taller than 4 ~ 5 mm in height.

- (a) Mount wheel/tire on wheel balance machine and balance in DYNAMIC MODE. Enable the LOAD ROLLER, if applicable, to ensure proper bead seating. Use **3M TN-2023** or equivalent lead-free stick-on type weights. (Figs. 5-1 & 5-2)
- (b) Prior to mounting stick-on weight, use a 50-50 Simple Green & Water solution (or equivalent locally approved cleaner), as needed, to clean the weight mounting location on wheel, then wipe down with a clean, dry, lint-free cloth. Ensure that the location is clean and dry. Apply stick-on type weights at perimeter location identified by dynamic balance machine, as shown. Use a rubber mallet, if required, to achieve complete adhesion of stick-on type weight(s).

NOTE: Maximum stick-on type weight is **100 g** (3.5 oz.) inner plane and **100 g** (3.5 oz.) outer plane. If weight required exceeds this, place machine in STATIC mode and proceed. If weight required still exceeds limit, rotate tire 180 degrees relative to wheel and repeat step 5. If removal and replacement of stick-on type weight is necessary, remove the weight using a nylon removal tool. Clean the surface with a clean cloth using locally approved cleaning solution. Wipe the surface dry before re-applying new weight(s). (DO NOT RE-USE STICK-ON WEIGHTS.)

- (c) Re-spin the wheel on the machine with LOAD ROLLER DISABLED (if applicable) and note the indicated remaining unbalance. The maximum permitted unbalance is 6 g (0.21 oz.) at inner and 6 g (0.21 oz.) at outer location. If the indicated unbalance is not within permissible limit, add required additional balance weights, within specification, and re-spin the tire/wheel assembly.

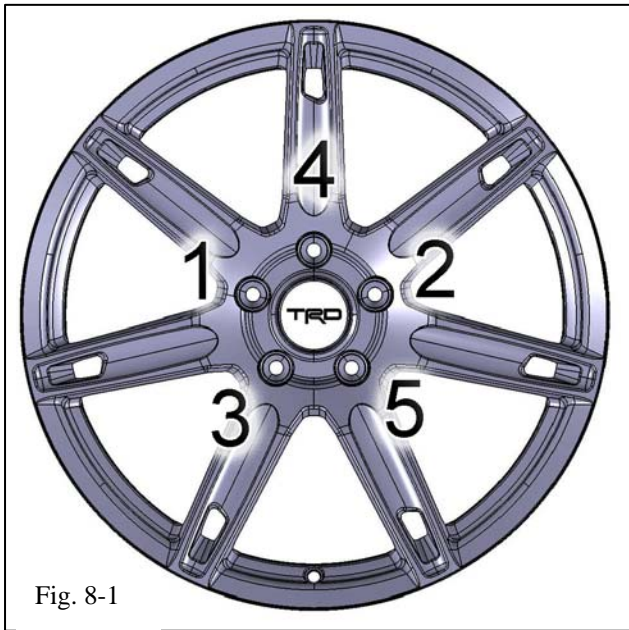
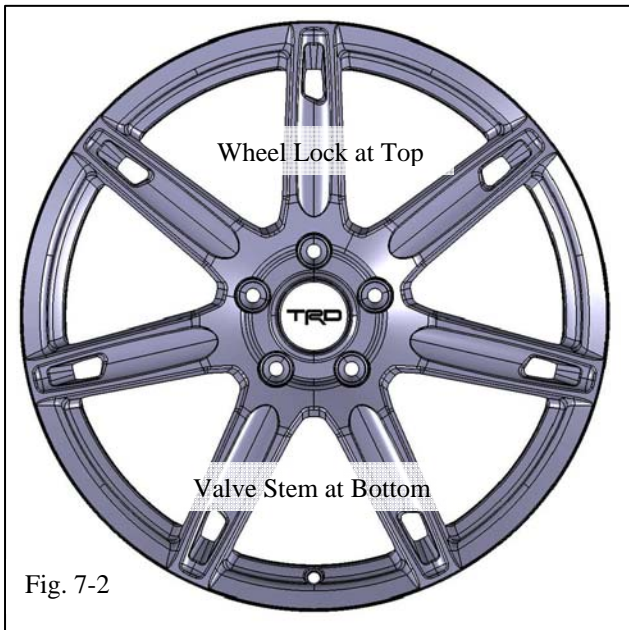
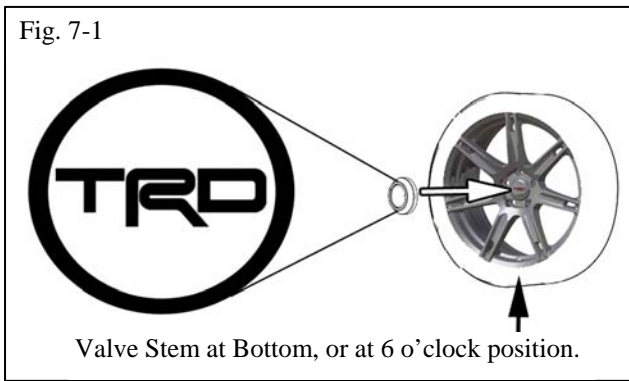

6. Tire Identification Number (TIN) Recording

! For PPO - Record **ALL 4** Tire Identification Numbers (TINs) from the **4** new tires installed onto the vehicle. Record these TINs with the Vehicle Identification Number (VIN) on form [TRD_tC_19in_Tire_ID_Numbers_RevA.xls](#) The TIN for the tire is an 11-character string located after the "DOT" symbol on the "RIGHT" sidewall of the tire. Refer to **CAD PPO Bulletin** database as needed.

! For DIO - Record **ALL 4** Tire Identification Numbers (TINs) from the **4** new tires installed onto the vehicle. Record these TINs with the Vehicle Identification Number (VIN). Provide the tire information to your tire vendor as required by law.

7. Center Cap Installation.

STOP **IMPORTANT! Be sure to install center caps BEFORE installing wheels onto vehicle!**

! (a) Install caps into wheels as shown in Fig. 7-1 & 7-2. Be sure to orient the TRD text relative to the valve hole (6 O'clock) as shown.

8. Vehicle Wheel / Tire Installation.

! (a) Install wheel/tire assemblies onto vehicle. Hand start the provided lug nuts. Install one wheel lock per wheel (excluding the spare) at the 12 O'clock, or top position, opposite valve stem (Fig 7.2). Tighten lug nuts in sequence 1 through 5 or equivalent star pattern. (Fig. 8-1). Ensure that the socket does not scuff the wheels.

! **DO NOT USE** an Impact Gun to install or damage may occur to Lugnuts!
Air ratchets are OK.

S Torque to **76 ft-lbf** (103 N-m)

(b) Remove vehicle from lift.

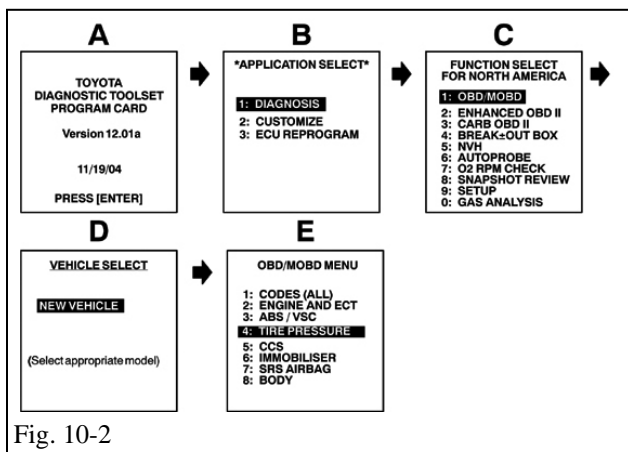
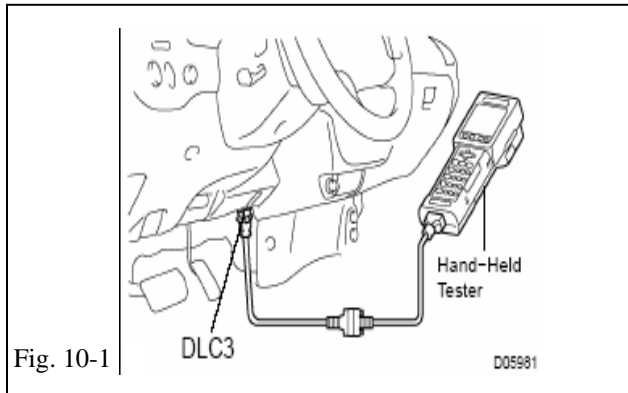
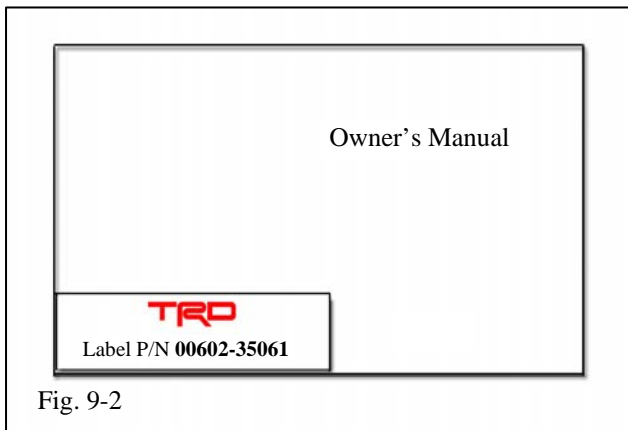
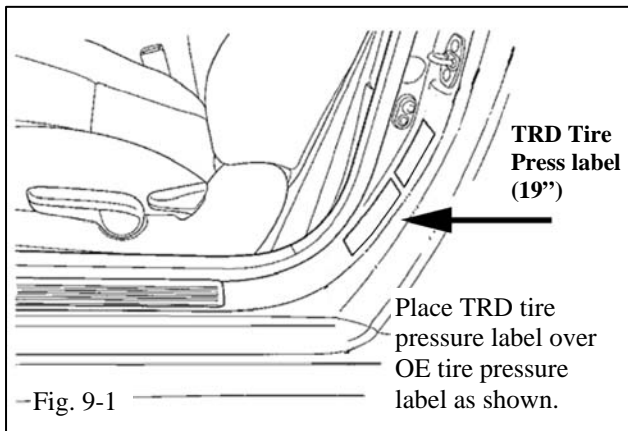

9. Tire Pressure Labels

- Clean the surface and a small area around the OE tire pressure label located on the driver's side door jamb.
- Affix the 18 inch tire pressure label (MDC P/N **00602-21011**) directly over the OE tire pressure label. (Fig. 9-1)
- Install Owner's Manual Label (MDC P/N **00602-35061**) onto front cover of owner's manual. (Fig. 9-2) NOTE: Be sure NOT to cover any existing text or information.

10. TPMS Transmitter ID Registration



Perform ONLY when replacing sensors. Skip to step 12 if re-using same 20 degree sensors.

Skip

to Step 11 if using a Techstream Device.

- Complete this section after all four wheels have been installed.
- Connect the hand-held tester to DLC3. (Fig. 10-1)
- Turn the ignition switch to the ON position.
- Turn on Tester and Select UTILITY - REGIST TIRE following the hand-held tester screen prompts. (Fig. 10-2 & Fig. 10-3)
- Input the TPMS ID codes (ID1 to ID4) from Step 3(b) using the hand-held tester to transmit them to the tire pressure monitor ECU. NOTE: Spare does NOT have TPMS.
- Make sure that the ID transmission condition "SUCCEEDED" is achieved.
- Confirm all the tire pressures are set to values recommended on the tire pressure label (Section 9.) for this vehicle.

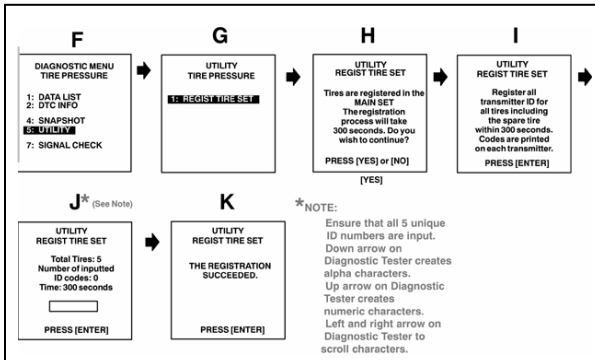

Fig. 10-3



NOTE: If this process is not completed within 5 minutes, the transmitter will return to normal operation mode and the process will need to be started over at step 10 (d).

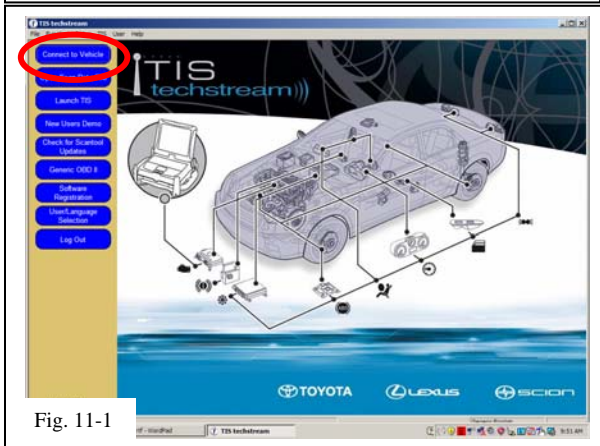

Fig. 11-1

11. TPMS Transmitter ID Registration Using Techstream.

- Connect the Techstream to DLC3, as in Fig. 10-1.
- Turn the ignition switch to ON position (do not start the vehicle) then turn the Techstream ON.
- Start the Techstream application by clicking on the shortcut located on the Desktop.
- Click “**Connect to Vehicle**” button. (Fig. 11-1)
- Confirm that the information displayed on the Vehicle Connection Wizard is correct. If not, make the appropriate selections from the Drop Down Menus then click “**Next**”. (Fig. 11-2)
- Select “**Tire Pressure Monitor**” then click the green arrow located on the bottom right. (Fig. 11-3)

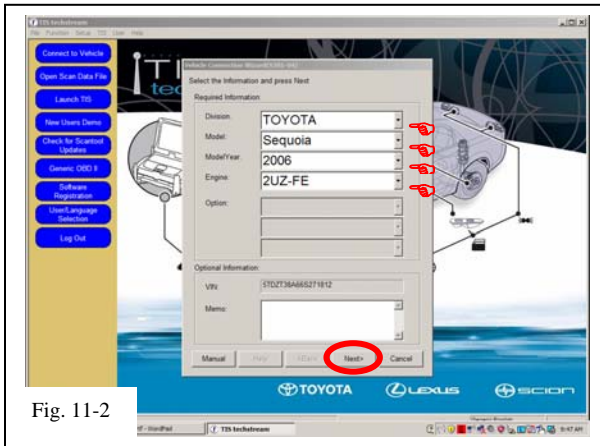

Fig. 11-2

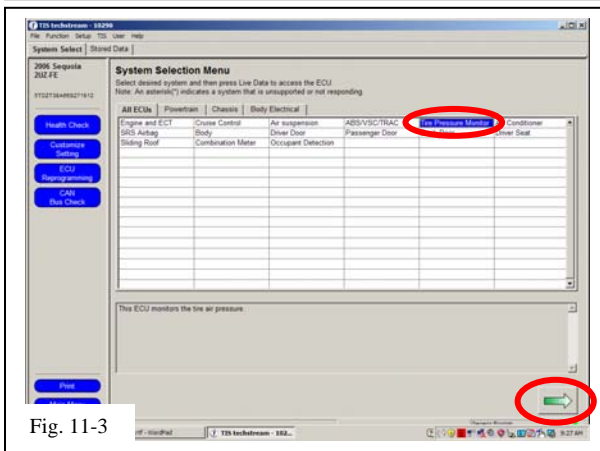

Fig. 11-3

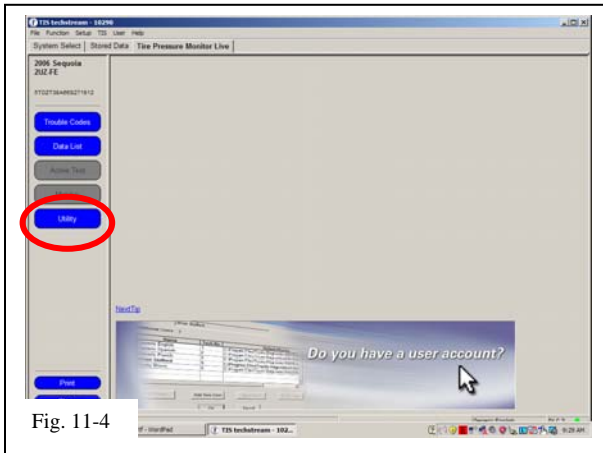

Fig. 11-4

(g) Select “UTILITY” to begin input of new TPMS ID codes (Fig. 11-4).

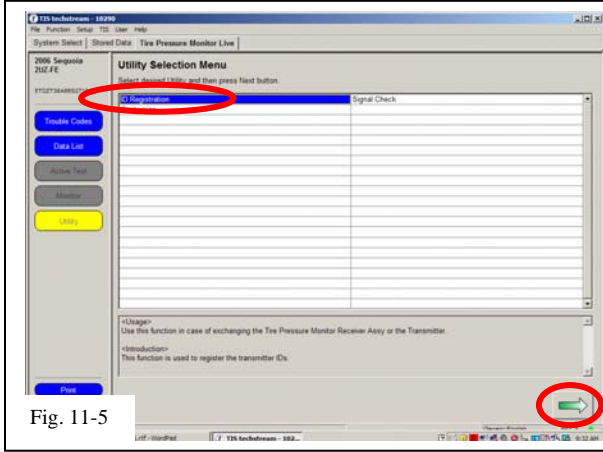

Fig. 11-5

(h) Select “ID Registration” then click the green arrow located at the bottom right corner. (Fig. 11-5)

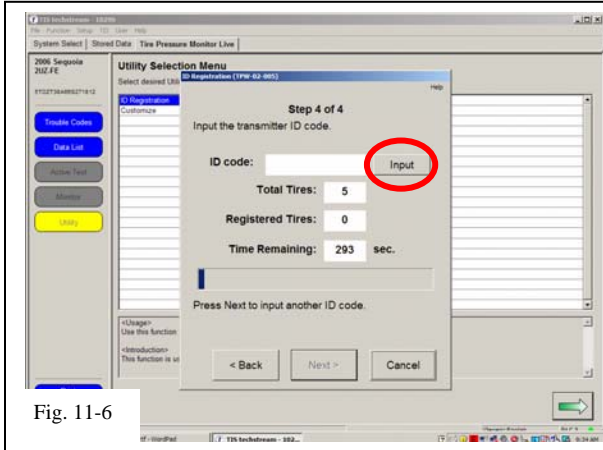

Fig. 11-6

(i) Select “Next” for Steps 1 through 3. Select “Input” in Step 4 to begin TPMS ID registration. (Fig. 11-6)

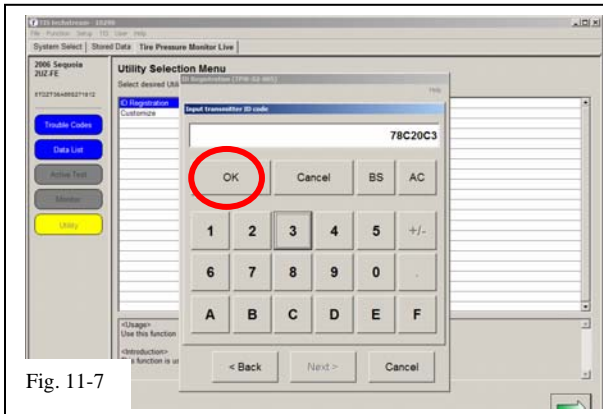

Fig. 11-7

(j) Input the TPMS ID code then click “OK” Repeat the same procedure for all other TPMS ID codes. (Fig. 11-7)
NOTE: If this process is not completed within 5 minutes, the transmitter will return to normal operation mode and process will need to be started over at step 11 (g).

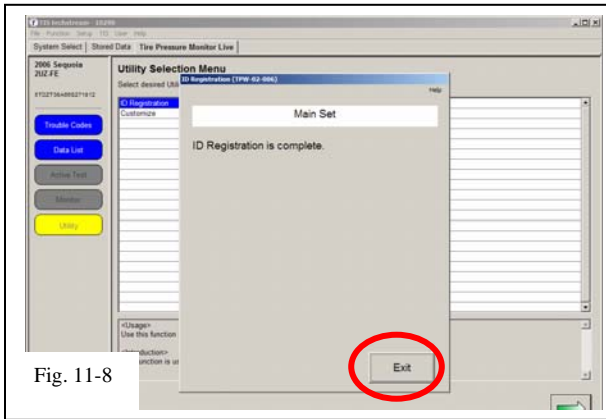

Fig. 11-8

(k) After all TPMS ID numbers have been registered, **“ID Registration is complete”** text should be displayed. Click **“Exit”** to finish the registration process. (Fig. 11-8)

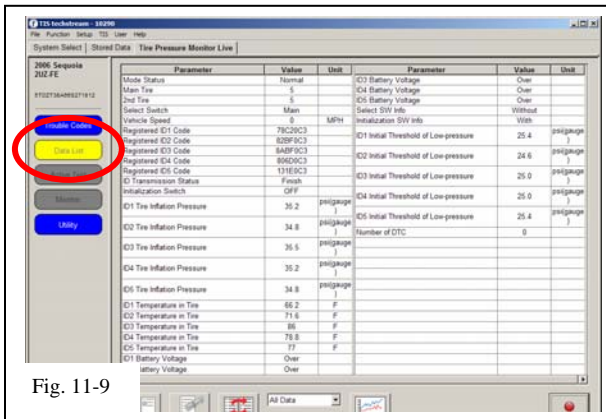

Fig. 11-9

(l) Select **“DATA LIST”** to view and confirm the TPMS ID numbers have been correctly registered (Fig 11-9).

12. Breakdown of OE Tire & Wheel Assembly

For PPO

- (a) Sort product properly according to local regulations.
- (b) Take-Off Tires get picked up by Dealer Tire.
- (c) Take-Off Wheels get salvaged according to local regulations.

For DIO

- (a) Sort product properly according to local regulations.

13. Lugnut Tool Placement.

PPO/DIO Place the Spline-Drive Lugnut Tool and Lock Key Tool along with the lock Instruction Card into Vinyl Pouch (PPO# PT276-06999 / DIO# 00602-06999) and secure in trunk in rear pocket near jack. Place all remaining associated wheel lock paperwork into vehicle glove compartment.

Checklist - these points **MUST** be checked to ensure a quality installation.

Check:

Look For:

Inspect lug nuts.

Verify five lug nuts must be installed on each wheel.

 Lug nut tightness.

 Verify Torque is **76 ft-lbf** (103 N-m).

 Lug nut tool placement.

Verify Lugnut Tool is in the appropriate location in vehicle.

Tire Pressure Labels

Verify Tire Pressure Label and Owner's Manual Labels are in place.

 Correct Tire Pressure

Verify tire pressure is set to the value specified on the TRD Tire Pressure Label.

Tire Identification Numbers

PPO: Ensure all **4** accessory Tire Identification Numbers are recorded with the Vehicle Identification Number on the sheet
[TRD_tC_19in_Tire_ID_Numbers_RevA.xls](#)
Refer to **CAD PPO Bulletin** as needed.

DIO: Provide the tire information to your tire vendor as required by law.

Center Caps

Verify center caps are securely in place on all 4 wheels.

Optional (DIO) Wheel Locks

Verify Wheel Lock Key Tool is in the appropriate location in vehicle and respective paperwork is placed into vehicle glove compartment.