

**Part Number: PTR56-18130 Front
PTR56-18131 Rear**

Kit Contents

Item #	Quantity Req'd.	Description
1	2 per vehicle	Wheel, Front, 18 x 7.0 x 35mm
2	2 per vehicle	Wheel, Rear, 18 x 7.5 x 35mm

Hardware Bag Contents

Item #	Quantity Req'd.	Description
1	1 per wheel	TRD Center Cap P/N PTR56-18130-AA
2		

Additional Items Required For Installation

Item #	Quantity Req'd.	Description
1	2 per vehicle on FRONT Axle	Tire: 215/40R18
2	2 per vehicle on REAR Axle	Tire: 225/40R18
3	As Required	Balance Weights, Lo-Profile Stick-on Type 3M TN-4023 or equivalent.
4	As Required	TPMS 20 degree angle Single DIO P/N SU003-00754
5	1	Tire Pressure Label MDC P/N 00602-18130
6	1	Owner's Manual Label MDC P/N 00602-35061
7	1 PPO 1 DIO	Optional Wheel Lock Pouch PT276-06999 00602-06999 (from the MDC)

Conflicts

None

Recommended Sequence of Application

Item #	Accessory
1	TRD 18" Alloy Wheels & 18" Tires
2	Wheel Locks, PPO/DIO PN PT276-18130
3	Wheel Lock Vinyl Pouch 00602-06999

Vehicle Service Parts (May be required for reassembly)

Item #	Quantity Req'd.	Description
1	0-4 as needed	Valve Stem Fit Kit (if required) Consult EPC or MicroCAT for correct TPMS P/N for your model and year.
2	0 - 4 as needed	TPMS 20 degree (if required) Consult EPC or MicroCAT for correct TPMS P/N for your model and year.







General Applicability

All 86 models

Recommended Tools

Personal & Vehicle Protection	Notes
Safety Glasses	
Seat Protection	Blanket
Special Tools	Notes
Tire Mounting Machine	Hunter TC3250 or equiv.
Wheel Balancing Machine	Hunter DSP9700 or equiv.
Centering Cone	Hunter 192-51-2 or equiv.
Wing Nut	Hunter 76-371-3 or equiv.
6.0 inch Cup w/ Sleeve	Hunter 175-392-1 or equiv.
6.0 inch protector Sleeve	Hunter 106-157-2 or equiv.
Foot Brake Application Tool	Snap-on B240A Pedal Jack or equivalent.
Toyota Techstream Device	Software Version 11.10.034 or newer required.
Installation Tools	Notes
Lug Nut Wrench	21 mm wrench flat
Torque Wrench	20-150 ft-lbf (27-204 N-m)
Torque Wrench	30-150 in-lbf (3.3-17 N-m)
Sockets	11mm and 21 mm Deep Well, Thin Wall
Extension	4-inch (as needed)
Rubber Mallet	
Clean Lint-free Cloth	
Nylon Panel Removal Tool	e.g. Toyota Pry Tool #1 Toyota SST # 00002-06001-01 or equiv.
Valve Stem Removal Tool	Schraeder Valve Type
Valve Stem Torque Tool	Snap-On QDTPMS or equiv.
Wire Brush	Hand held size
Special Chemicals	Notes
Tire Lube / Paste	Myers or equivalent
Cleaner (for rework of stick on weights if needed)	Locally approved cleaner

Legend

	STOP: Damage to the vehicle may occur. Do not proceed until process has been complied with.
	OPERATOR SAFETY: Use caution to avoid risk of injury.
	CAUTION: A process that must be carefully observed in order to reduce the risk of damage to the accessory/vehicle and to ensure a quality installation.
	TOOLS & EQUIPMENT: Used in Figures calls out the specific tools and equipment recommended for this process.
	REVISION MARK: This mark highlights a change in installation with respect to previous issue.
	SAFETY TORQUE: This mark indicates that torque is related to safety.

Care must be taken when installing this accessory to ensure damage does not occur to the vehicle. The installation of this accessory should follow approved guidelines to ensure a quality installation.

These guidelines can be found in the "Accessory Installation Practices" document.

This document covers such items as:-

- Vehicle Protection (use of covers and blankets, cleaning chemicals, etc.).
- Safety (eye protection, rechecking torque procedure, etc.).
- Vehicle Disassembly/Reassembly (panel removal, part storage, etc.).
- Electrical Component Disassembly/Reassembly (battery disconnection, connector removal, etc.).

Please see your Toyota dealer for a copy of this document.

1. Prepare the Vehicle.



STOP (a) Firmly apply the parking brake (Fig. 1-1).

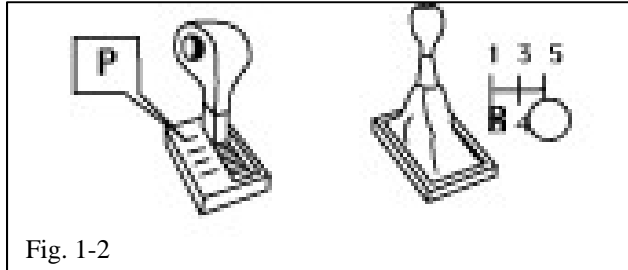

STOP (b) Put automatic transmission in "P". Put manual transmission in "R" (Fig. 1-2).

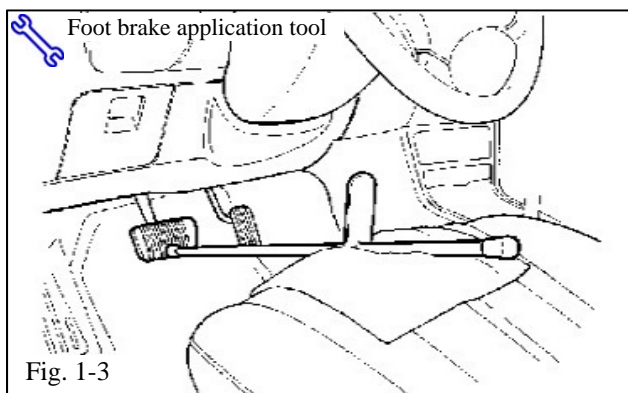

(c) Add seat protection (blanket) and apply the foot brake using a foot brake application tool (Fig. 1-3).

(d) Lift the vehicle.

STOP CAUTION: Place a safety stand under the front of the vehicle or under the front pinch seam, "jack position," while the vehicle is off the ground for additional vehicle support.

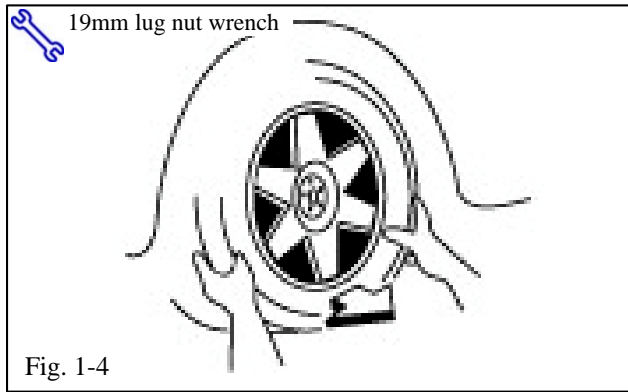

- +** (e) Remove the OE wheel and tire assembly from the vehicle (Fig. 1-4). Wear safety glasses while removing wheels.

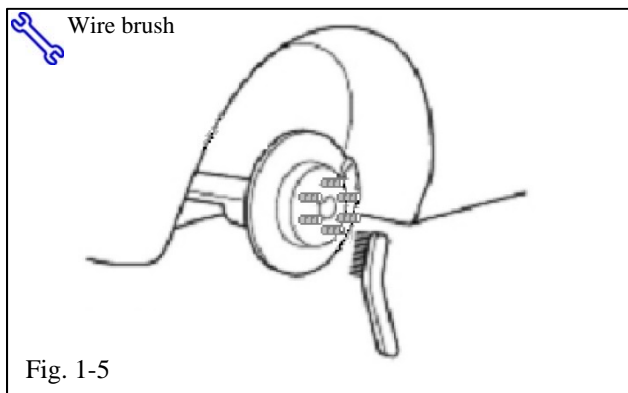

- +** (f) If required, remove any corrosion on the mounting surface of the vehicle with a wire brush (Fig. 1-5). Wear safety glasses to protect against any debris.

2. Remove the Tire Pressure Monitor Valve Sub-assembly.

! **NOTE: The 20-degree Tire Pressure Sensors MUST stay with the same vehicle!**

- (a) Remove & retain the valve cores and release the air from all four tires.
- (b) Remove & retain the nuts and washers and let the pressure sensors drop inside the tires.
- (c) Carefully separate the outer tire bead from the wheel rim (Fig. 2-1).

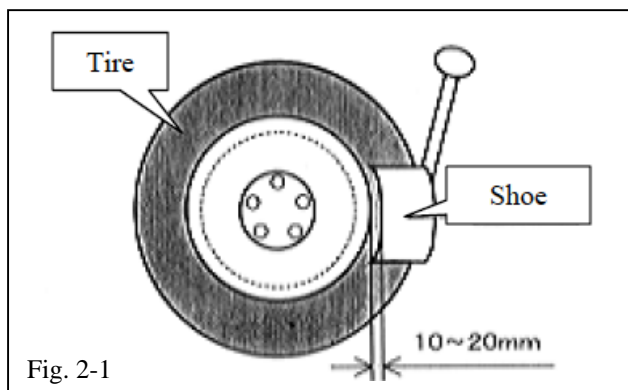

STOP **NOTE: Be careful not to damage the tire pressure monitor due to interference between the sensor and tire bead.**

- (d) Remove the sensor from the tire and remove the bead on the lower/inner side as in the usual tire removal operation.
- (e) Dismount the OE tire from the OE wheel.
- (f) Repeat for all four tires.

3. Install the Tire Pressure Monitor Sensor (TPMS) Sub-assembly into the Accessory Wheels.

- (a) Check that the wheel valve hole is clean and free of sharp edges or burrs.
- (b) Check that the rim is clean.
- (c) Visually check that no deformation or damage exists on the tire pressure monitor valve sub-assembly.
- (d) Check that the grommet, washer and nut are all clean and in good condition.

STOP **NOTE:** Replace the grommet ONLY IF the grommet is old or was damaged. A damaged grommet is NOT reusable.

- (e) Insert the tire pressure monitor valve sub-assembly into the wheel valve hole from the inside of the rim and bring the valve stem to the outside (Fig. 3-1).
- (f) Insert the tire pressure monitor valve sub-assembly so that the "Manufacturer's" mark is visible.

STOP **NOTE:** Incorrect orientation of the pressure monitor sub-assembly may cause damage and prevent signal transmission during high-speed driving.

- !** (g) Install the washer on the outside of the wheel and secure it with the nut.

S **Torque: 36 in-lbf (4.0 N-m)**

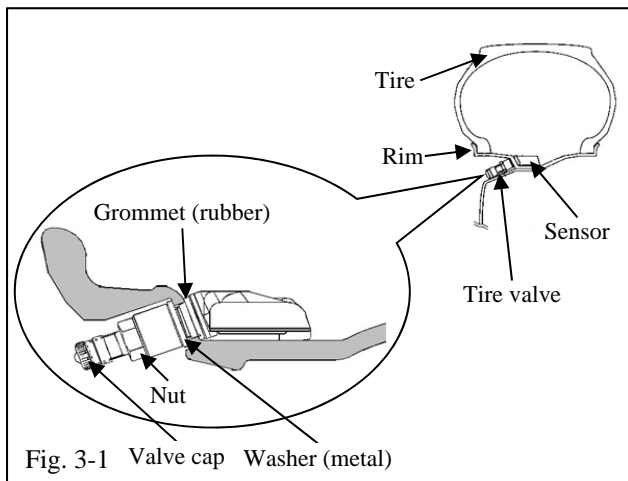

Fig. 3-1 Valve cap Washer (metal)

4. Mount the Tires.

STOP NOTE: Some tires are **DIRECTIONAL**. You must mount **2 LEFTS** and **2 RIGHTS** per vehicle **IF** tires are directional. Rotation direction (if any) is indicated on the tire sidewall.

- (a) Use tire lube on the tire beads and bead locations on the wheel prior to mounting the tire.
- (b) Position the wheel on the mounting machine with the sensor at ~ 7 o'clock position (shaded area in Fig. 4-1).

(1) The mount/dismount head is considered as 12 o'clock.

- (c) Mount the lower tire bead.

STOP NOTE: If the sensor is positioned outside this area, it generates interference with the tire bead, causing possible damage to the sensor.

- (d) Reposition the wheel on the mounting machine with the sensor at ~ 7 o'clock position (shaded area in Fig. 4-1).

- (e) Mount the upper tire bead.

STOP NOTE: If the mounting machine rotates in the counterclockwise direction, refer to Fig. 4-2 for sensor placement.

STOP NOTE: Make sure that the tire bead and tool does not interfere with the main body of the sensor and the bead does not clamp sensor.

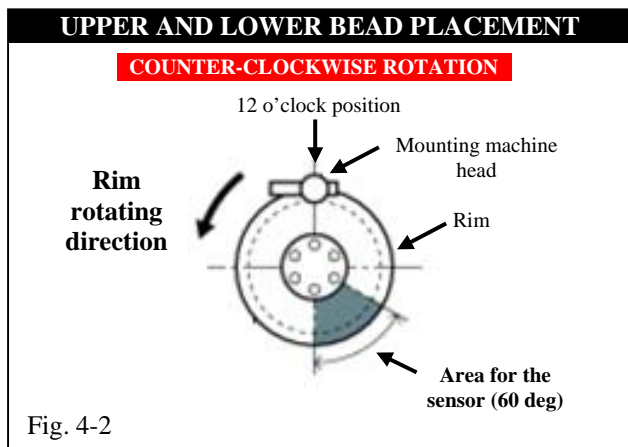
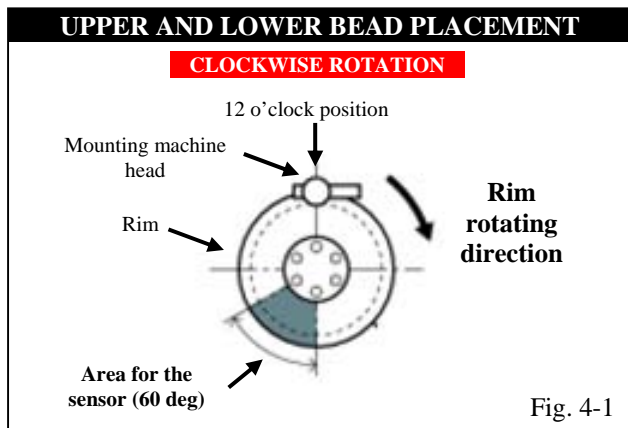

-  (f) To seat the tire beads, inflate the tire beyond 35 PSI (240 kPa) but not more than the maximum tire bead seat pressure indicated on the tire sidewall. If it is not indicated, use 40 PSI (275 kPa) as a limit. If both tire beads are not seated when the pressure registers 40 PSI (275 kPa), deflate the tire and re-inflate it to seat the beads.
- (g) Install and torque the valve stem cores with the valve stem torque tool.
- (h) Regulate the tire pressures.
FRONT: **38 PSI** (260 kPa)
REAR: **35 PSI** (240 kPa)
- (i) Be sure to **recheck the torque** on the TPMS nuts.

 **Torque: 36 in-lbf (4.0 N-m)**

- (j) Install the valve stem caps by hand.

5. Balance the Wheels.

 **NOTE:** Application temperature for stick-on type weight is above 50°F (10°C). It is good practice to apply the stick-on type in sections comprised of no more than 5 or 6 individual weight segments. This wheel requires stick-on weight on the outer rim and clip-on weight on the inner rim for correct balancing.

- (a) Remove the tire labels from the tire tread.

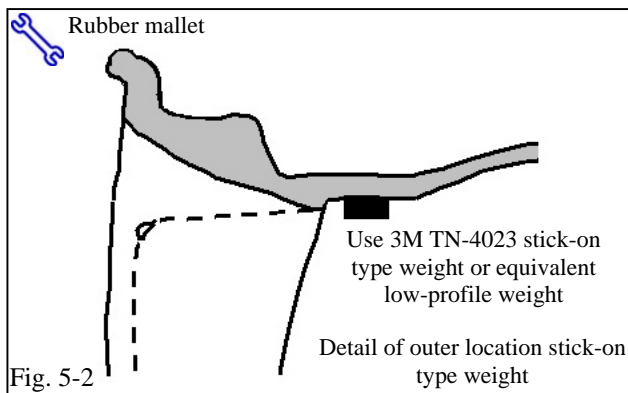
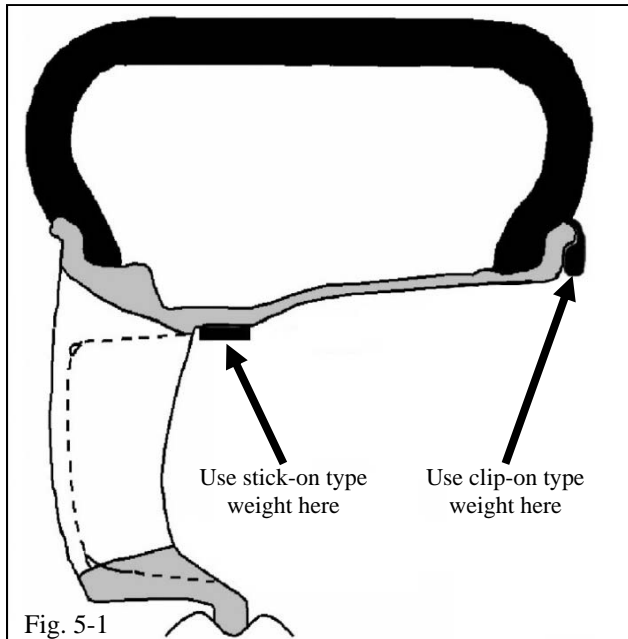

- (b) Prior to mounting stick-on weight, use VDC-approved cleaner as needed to clean the weight mounting location on the wheel, then wipe down with a clean, dry, lint-free cloth. Ensure that the location is clean and dry.
- (c) Mount the wheel/tire on the wheel balance machine and balance in DYNAMIC MODE. Enable the LOAD ROLLER, if applicable, to ensure proper bead seating. Use clip-type balance weights on the inner rim lip and stick-on type weights at outer location (Fig. 5-1 & Fig. 5-2). Use a rubber mallet, if required, to achieve complete adhesion of stick-on type weight(s).

⚠ NOTE: Weights should be no taller than 4 ~ 5 mm in height.

⚠ NOTE: The maximum allowable amount of clip-on type weight on the inner rim is **100 g (3.5 oz.)**. The maximum allowable amount of stick-on type weight on the outer rim **100 g (3.5 oz.)**. If weight required exceeds this, place machine in STATIC mode and proceed. If weight required still exceeds limit, rotate tire 180 degrees relative to wheel and repeat Step 5(c). If removal and replacement of stick-on type weight is necessary, remove the weight using a nylon removal tool. Clean the surface with a clean cloth using a locally approved cleaning solution. Wipe the surface dry before re-applying new weight(s). **DO NOT RE-USE STICK-ON WEIGHTS.**

- (d) Re-spin the wheel on the machine with the LOAD ROLLER DISABLED (if applicable) and note the indicated remaining unbalance. The maximum permitted unbalance is 6 g (0.21 oz.) at the inner location and 6 g (0.21 oz.) at the outer location. If the indicated unbalance is not within the permissible limit, add required additional balance weights, within specification, and re-spin the tire/wheel assembly.

6. Record the Tire Identification Number (TIN).

- (a) For PPO - Record ALL 4 Tire Identification Numbers (TINs) from the 4 new tires installed onto the vehicle. Record these TINs with the Vehicle Identification Number (VIN) on form TRD_FRS_18in_Tire_ID_Numbers_RevA.xls The TIN for the tire is an 11 or 12 character string located after the "DOT" symbol on the sidewall of the tire. Refer to CAD PPO Bulletin database as needed.
- (b) For DIO - Record ALL 4 Tire Identification Numbers (TINs) from the 4 new tires installed onto the vehicle. Record these TINs with the Vehicle Identification Number (VIN). Provide the tire information to your tire vendor as required by law.

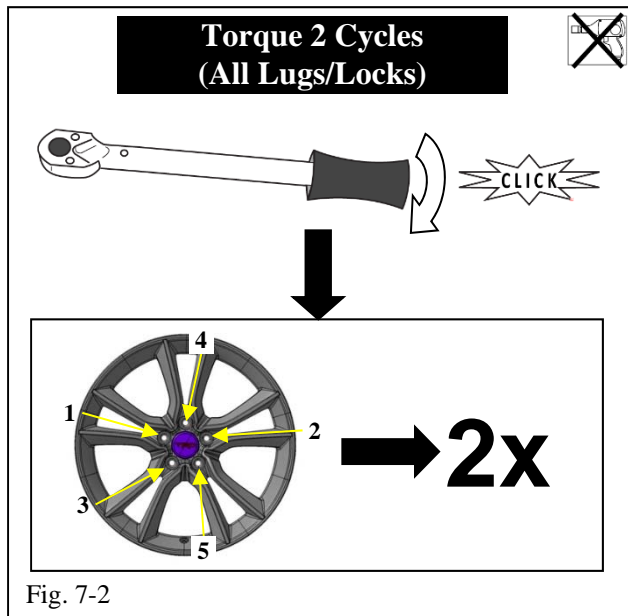
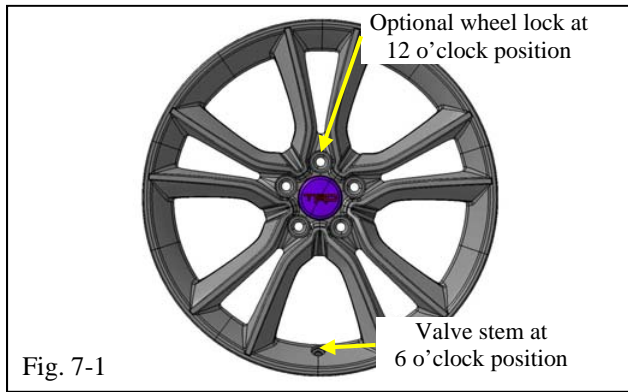

7. Install the Wheels / Tires on the Vehicle.

STOP **IMPORTANT!** Be sure to install center caps **BEFORE** installing wheels onto vehicle!

! (a) Install the center caps into the wheels. Be sure to orient the TRD logo right side up and level in relationship to the valve stem when it is in the 6 o'clock position. Gently push the center cap into the wheel until the cap snaps into place (Fig. 7-1).

(b) Install the wheel/tire assemblies onto the vehicle. Hand start the lug nuts.

! **NOTE:** If wheel locks are being added, install one wheel lock per wheel at the 12 o'clock position with the valve step at the 6 o'clock position (Fig. 7-1).

(c) Tighten the lug nuts in sequence 1 through 5 or equivalent star pattern (Fig. 7-2). Ensure that the socket does not scuff the wheels. Tighten to 89 ft-lbf (120 N-m) using a torque wrench.

S **Torque: 89 ft-lbf (120 N-m)**

STOP **CAUTION: DO NOT USE AN IMPACT WRENCH TO INSTALL OR REMOVE WHEEL LOCKS.**

(d) Re-torque all lug nuts in the same 1-5 sequence (Fig. 7-2).

S **Torque: 89 ft-lbf (120 N-m)**

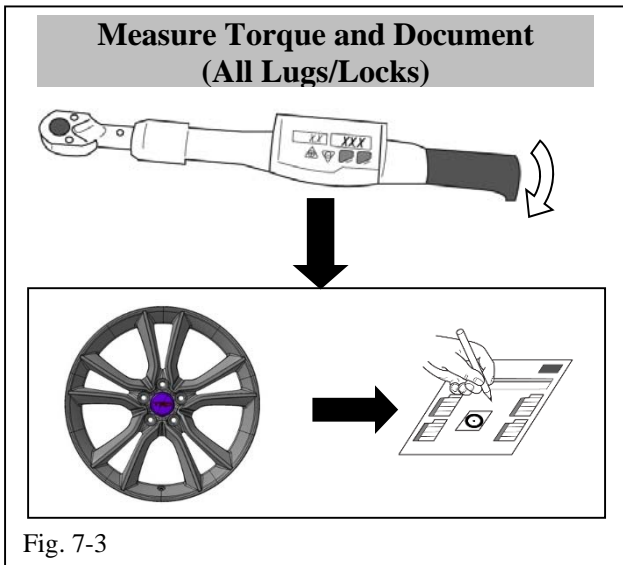

- (e) With the vehicle still on the lift, use a digital torque wrench to measure the torque of each lug nut/lock and record it on the Torque Audit Sheet (Fig. 7-3) (PPO installation only, does not apply to DIO installation).
- (f) Lower the vehicle.
- (g) Install the valve stem caps.

8. Install the Tire Pressure Labels.

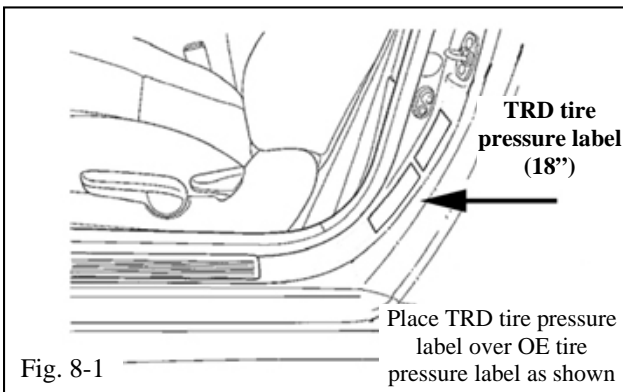

- (a) Clean the surface of, and a small area around, the OE tire pressure label located on the driver's side door jamb (Fig. 8-1).
- (b) Affix the TRD 18-inch tire pressure label (MDC P/N **00602-18130**) directly over the OE tire pressure label (Fig. 8-1)

⚠ NOTE: Do NOT cover any of the OE label occupant & cargo capacity text. Cover ONLY the black & red boxes containing the OE tire size and pressure information (Fig. 8-2).



- (c) Install the Owner's Manual Label (MDC P/N 00602-35061) onto front cover of owner's manual (Fig. 8-3).

⚠ NOTE: Be sure NOT to cover any existing text or information.

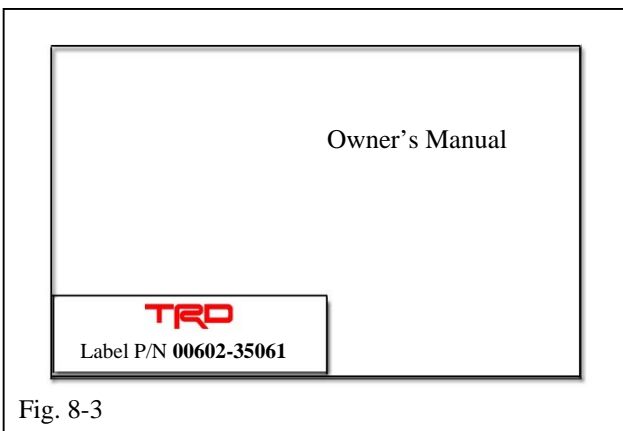

9. Register the TPMS Transmitter IDs Using Techstream.

- (a) Connect the Techstream to DLC3.
- (b) Turn/toggle the ignition switch to the ON position (do not start the vehicle), then turn the Techstream ON.
- (c) Start the Techstream application by clicking on the shortcut located on the Desktop.
- (d) Click “Connect to Vehicle” button (Fig. 9-1).

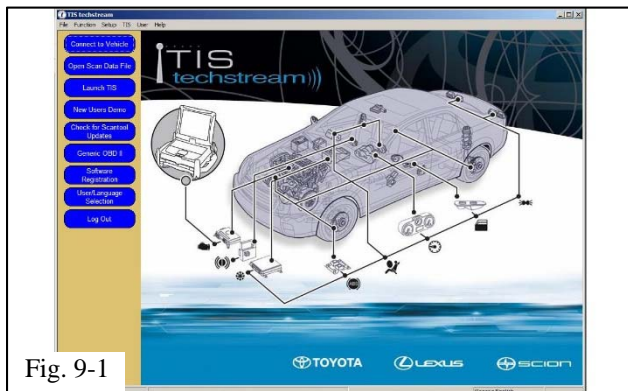

Fig. 9-1

- (e) Confirm that the information displayed on the Vehicle Connection Wizard is correct. If not, make the appropriate selections from the drop down menus, then click “Next” (Fig. 9-2).

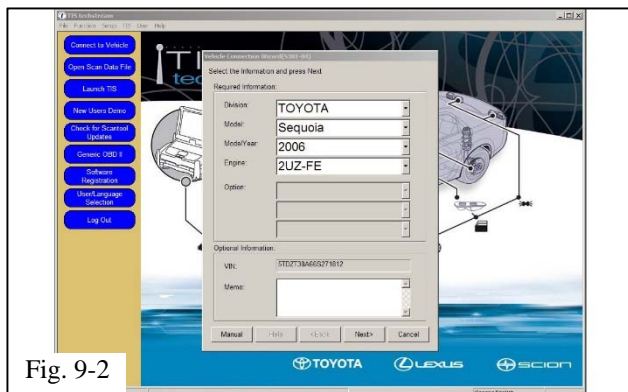

Fig. 9-2

- (f) Select “Tire Pressure Monitor”, then click the green arrow located on the bottom right (Fig. 9-3).

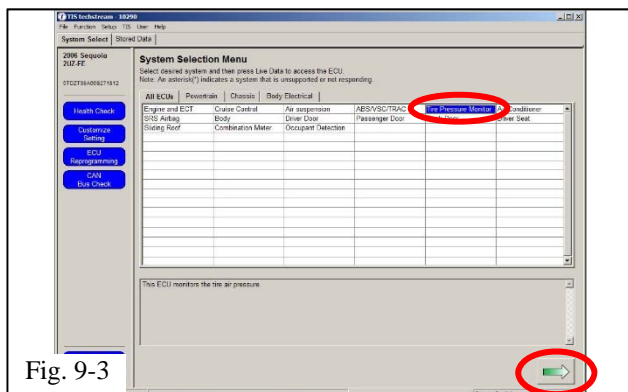

Fig. 9-3

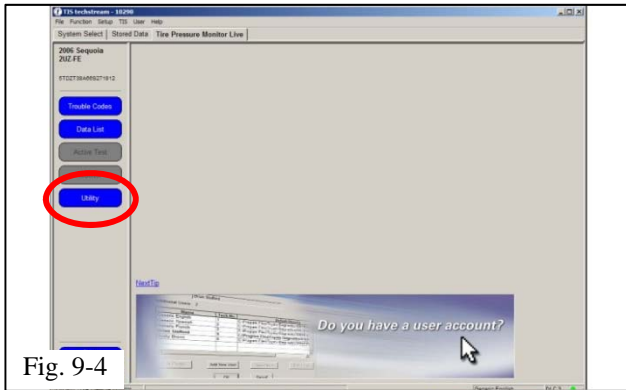

Fig. 9-4

(g) Select **“UTILITY”** to begin input of new TPMS ID codes (Fig. 9-4).

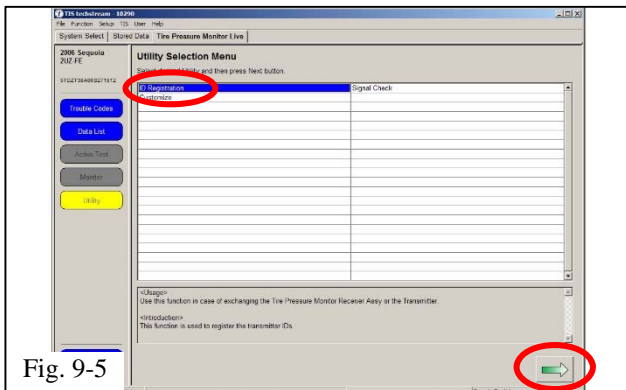

Fig. 9-5

(h) Select **“ID Registration”** then click the green arrow located at the bottom right corner (Fig. 9-5).

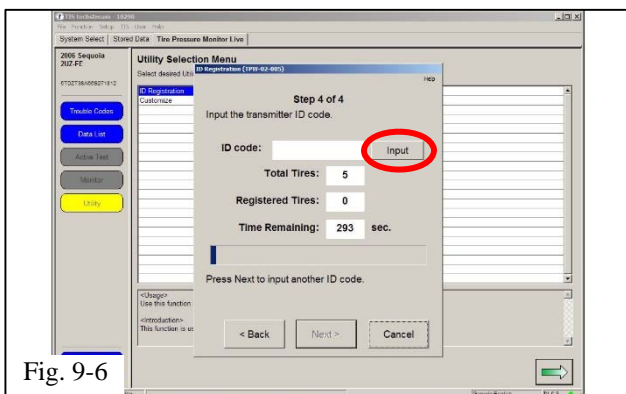

Fig. 9-6

(i) Select **“Next”** for Steps 1 through 3. Select **“Input”** in Step 4 to begin TPMS ID registration (Fig. 9-6).

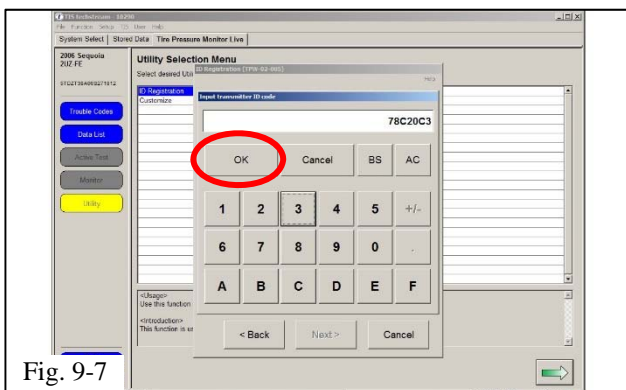

Fig. 9-7

(j) Input the TPMS ID code then click **“OK”**
Repeat the same procedure for all other TPMS ID codes (Fig. 9-7).

⚠ NOTE: If this process is not completed within 5 minutes, the transmitter will return to normal operation mode and process will need to be started over at Step 9(g).

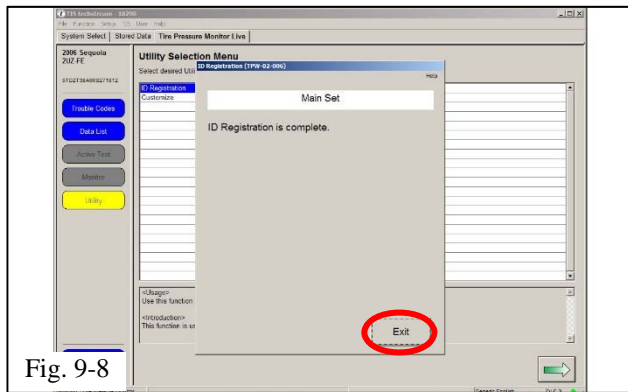

Fig. 9-8

- (k) After all of the TPMS ID numbers have been registered, “ID Registration is complete” text should be displayed. Click “Exit” to finish the registration process (Fig. 9-8).

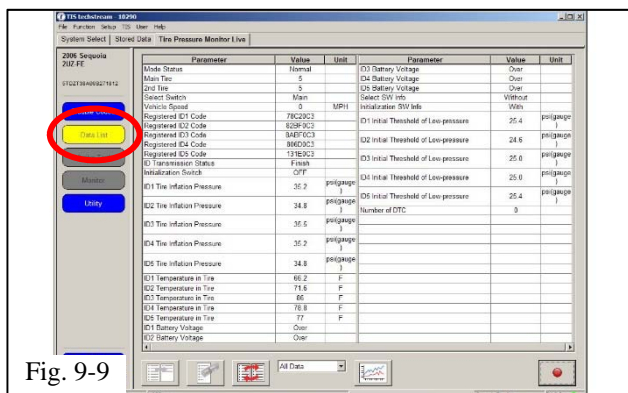

Fig. 9-9

- (l) Select “DATA LIST” to view and confirm the TPMS ID numbers have been correctly registered (Fig. 9-9).

10. Breakdown the OE Tire & Wheel Assemblies.

(a) PPO:

- (1) Sort product properly according to local regulations.
- (2) Take-off tires get picked up by Dealer Tire.
- (3) Take-off wheels get salvaged according to local regulations.

(b) DIO:



- (1) Sort product properly according to local regulations.

11. Place the Optional Wheel Lock Tool.

- (a) Place the Lock Key Tool into the storage tray and secure in trunk in rear pocket near jack.
- (b) Place all remaining associated wheel lock paperwork into vehicle glove compartment.

Checklist - these points **MUST** be checked to ensure a quality installation.

Check:

- Correct part number has been installed
-  Inspect Lug Nuts & Torque
-  TPMS Torque
- Tire Pressure Labels
- Record Lug & Lock Torque
- Center Caps
- Correct Tire Pressure
- Driver Instrument Panel
- Record TIN
- Optional (DIO) Wheel Locks

Look For:

Verify part number on packages.

Verify that five lug nuts/locks are installed on each wheel and the optional wheel lock is in the correct position. Torque must be **89 ft-lbf (120 N-m)**.

TPMS nut must be torqued to **36 in-lbf (4.0 N-m)**.

Verify TRD Tire Pressure Label and TRD Owner's Manual Labels are in place.

Measure the torque of each lug/lock on all wheels and record it on the Torque Audit Sheet (PPO installation only, does not apply to DIO installation).

Verify center caps are securely in place on all four wheels & oriented correctly.

Verify tire pressure is set to the value specified on the TRD Tire Pressure Label.

Verify "TPMS warning light" is not ON.

PPO: Ensure all **4** accessory Tire Identification Numbers are recorded with the Vehicle Identification Number on the TRD_FRS_18in_Tire_ID_Numbers_RevA.xls sheet and/or electronic Port/VDC recording system. Refer to the **CAD PPO Bulletin** as needed.

DIO: Provide the tire information to your tire vendor as required by law.

Verify Wheel Lock Key Tool is secure in the appropriate location in vehicle and respective paperwork is placed into vehicle glove compartment.

Vehicle Appearance Check

- After accessory installation and removal of protective cover(s), perform a visual inspection.

Ensure no damage (including scuffs and scratches) was caused during the installation process.
(For PPO installations, refer to TMS Accessory Quality Shipping Standard.)