

Preparation

Part Number: PT945-47160

Kit Contents

Item #	Quantity Req'd.	Description
1	4 per vehicle	Al Wheel 15" x 6.5" x 40mm

Hardware Bag Contents

Item #	Quantity Req'd.	Description
1	1 per wheel	Center Cap P/N PT945-47161-AA
2		
3		

Additional Items Required For Installation

Item #	Quantity Req'd.	Description
1	1 per wheel	OE Tire: P195/65R15 89S
2	As needed	Low-Profile, Lead-Free Stick-on Type Balance Weights 3M TN-4023 (or equivalent)
3	0-4 as needed	OE TPMS 20-degree angle Single DIO P/N 42607-52020
4	5 per wheel, reuse OE	OE Flat-Seat Lug Nut P/N 90942-01033
5		OE 15" Tire Pressure Label
6		

Conflicts

None

General Applicability

2016 and newer Toyota Prius 2017 and newer Toyota Prius Prime Use with OE tire size P195/65R15 89S
--

Recommended Sequence of Application

Item #	Accessory
1	15" Alloy Wheel & 15" OE Tire
2	Optional Wheel Locks, PN 00276-00900







Vehicle Service Parts (May be required for reassembly)

Item #	Quantity Req'd.	Description
1	0-4 as needed	Valve Stem Grommet Fit Kit (if required) P/N 04423 -0E010
2	0 - 4 as needed	20° TPMS Single P/N 42607-52020

Recommended Tools

Personal & Vehicle Protection	Notes
Safety Glasses	
Seat Protection	Blanket
Special Tools	Notes
Tire Changing Machine	Hunter or Corghi or equiv.
Wheel Balancing Machine	Hunter GSP9700 or equiv.
Centering Cone	Hunter BACK-SIDE collet 192-154-2 or equiv.
Wing Nut	Hunter 76-371-3 or equiv.
4.5" Cup w/ Sleeve	Hunter 175-353-1 or equiv.
4.5" Protector Sleeve	Hunter 106-82-2 or equiv.
Foot Brake Application Tool	Snap-on B240A Pedal Jack or equivalent.
Toyota Techstream	Software Version 10.20.030 or newer
Installation Tools	Notes
Lug Nut Wrench	21 mm wrench flat
Torque Wrench	20-150 ft-lbf (27-204 N-m)
Torque Wrench	30-150 in-lbf (3.3-17 N-m)
Sockets	11mm and 21 mm Deep Well, Thin Wall
Extension	4-inch (as needed)
Rubber Mallet	
Clean Lint-free Cloth	
Nylon Panel Removal Tool	e.g. Toyota Pry Tool #1 Toyota SST # 00002-06001-01 or equiv.
Valve Stem Removal Tool	Schraeder Valve Type
Valve Stem Torque Tool	Snap-On QDTPMS or equiv.
Wire Brush	Hand held size
Special Chemicals	Notes
Tire Lube / Paste	Myers or equivalent
Cleaner (for rework of stick on weights if needed)	Locally approved cleaner

Legend

	STOP: Damage to the vehicle may occur. Do not proceed until process has been completed with.
	OPERATOR SAFETY: Use caution to avoid risk of injury.
	CAUTION: A process that must be carefully observed in order to reduce the risk of damage to the accessory/vehicle and to ensure a quality installation.
	TOOLS & EQUIPMENT: Used in Figures calls out the specific tools and equipment recommended for this process.
	REVISION MARK: This mark highlights a change in installation with respect to previous issue.
	SAFETY TORQUE: This mark indicates that torque is related to safety.

Care must be taken when installing this accessory to ensure damage does not occur to the vehicle. The installation of this accessory should follow approved guidelines to ensure a quality installation.

These guidelines can be found in the "Accessory Installation Practices" document.

This document covers such items as:-

- Vehicle Protection (use of covers and blankets, cleaning chemicals, etc.).
- Safety (eye protection, rechecking torque procedure, etc.).
- Vehicle Disassembly/Reassembly (panel removal, part storage, etc.).
- Electrical Component Disassembly/Reassembly (battery disconnection, connector removal, etc.).

Please see your Toyota dealer for a copy of this document.

1. Prepare the Vehicle.

- STOP** (a) Firmly apply the parking brake.
- STOP** (b) Put automatic transmission in "P" (Fig. 1-1).
Put manual transmission in "R".

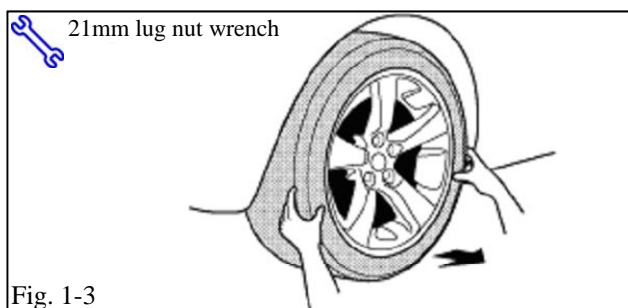
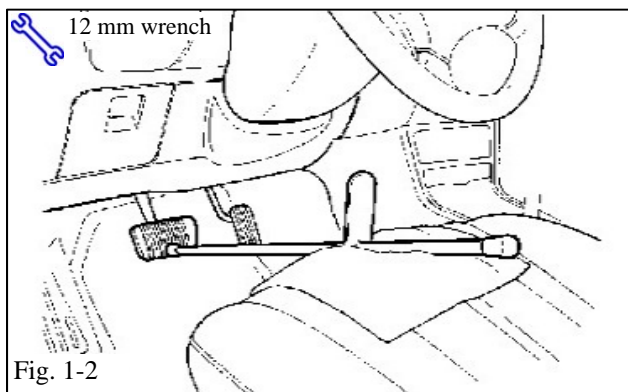
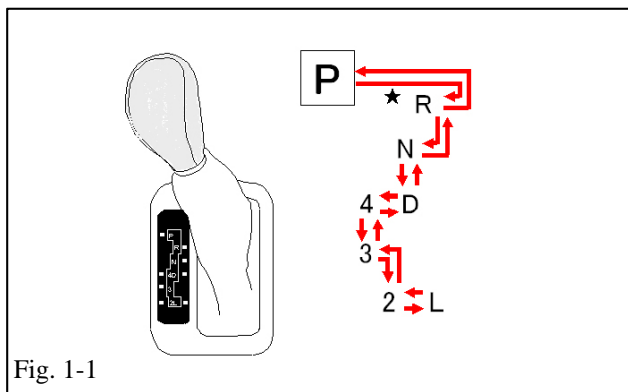

- (c) Add seat protection (blanket) and apply the foot brake using a foot brake application tool (Fig. 1-2).
- (d) Lift the vehicle.
- +** (e) Remove the OE wheel and tire assembly from the vehicle (Fig. 1-3). Wear safety glasses while removing wheels.

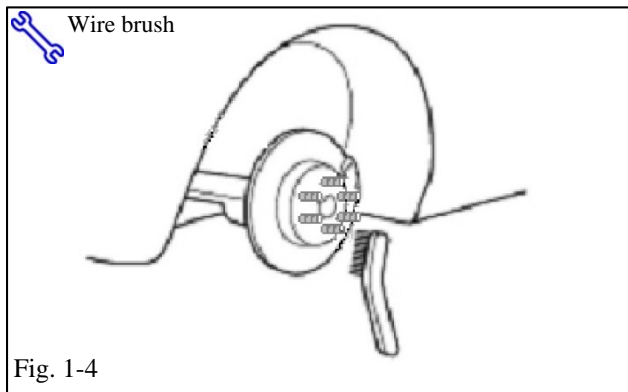

- ✚ (f) If required, remove any corrosion on the mounting surface of the vehicle with a wire brush (Fig. 1-4). Wear safety glasses to protect against any debris.

2. Remove the Tire Pressure Monitor Valve Sub-assembly.

⚠ NOTE: The 20-degree Tire Pressure Sensors MUST stay with the same vehicle!

⚠ NOTE: 40-degree sensors are NOT reused on ANY Accessory Alloy Wheels! (Fig. 2-1)

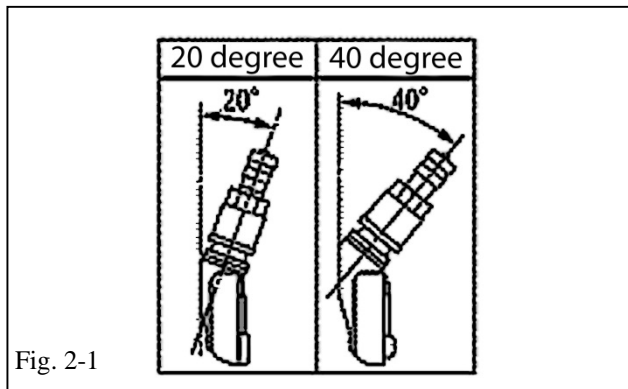

- (a) Remove & retain the valve cores and release the air from all four tires.
- (b) Remove & retain the nuts and washers and let the pressure sensors drop inside the tires.

- (c) Carefully separate the outer tire bead from the wheel rim (Fig. 2-2).

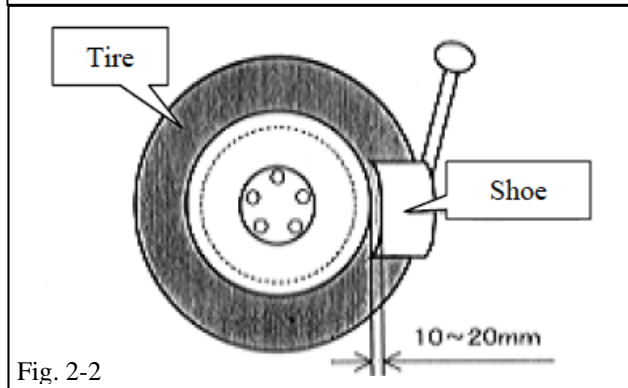

STOP NOTE: Be careful not to damage the tire pressure monitor due to interference between the sensor and tire bead.

- (d) Remove the sensor from the tire and remove the bead on the lower/inner side as in the usual tire removal operation.
- (e) Dismount the OE tire from the OE wheel.
- (f) Repeat for all four tires.

3. Install the Tire Pressure Monitor Sensor (TPMS) Sub-assembly into the Accessory Wheels.

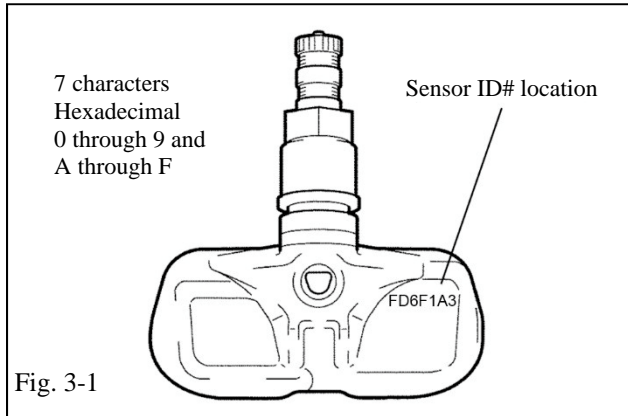

- (a) If the previously removed sensor is a 20 degree sensor, proceed to step **3(c)**. If the previously removed sensor is a 40 degree sensor, you must install new 20 degree sensors into the accessory wheels. When installing new 20 degree sensors, you **MUST** record sensor ID codes for all four wheels and register these four new ID codes (Fig. 3-1) with the vehicle ECU. Each sensor has a unique sensor ID code. The sensor ID code is a 7 or 8-character hexadecimal string comprised of numbers 0 through 9 and letters A through F. See Fig. 3-1 for example code and location.

⚠ (b) IMPORTANT! Record all four new TPMS ID codes onto a sheet of paper or in a shop notebook. These **MUST** be programmed into the vehicle ECU later in **Step 10**.

- (c) Check that the wheel valve hole is clean and free of sharp edges or burrs.
- (d) Visually check that no deformation or damage exists on the tire pressure monitor valve sub-assembly. Check that the grommet, washer and nut are all clean and in good condition.

STOP NOTE: Replace the grommet ONLY IF the grommet is old or was damaged. A damaged grommet is NOT reusable.

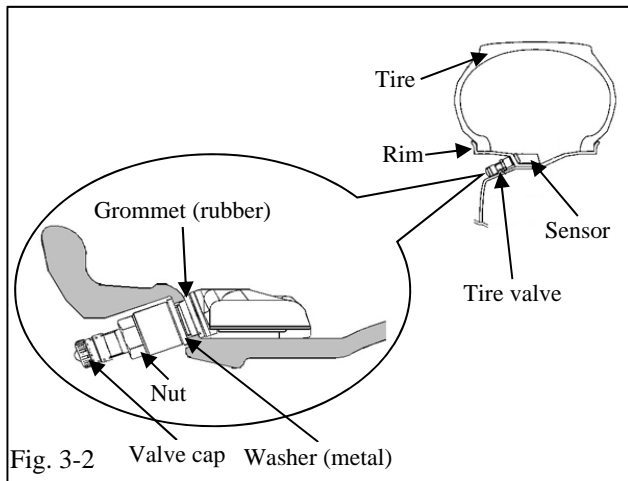

- (e) Insert the tire pressure monitor valve sub-assembly into the wheel valve hole from the inside of the rim and bring the valve stem to the outside (Fig. 3-2).
- (f) Insert the tire pressure monitor valve sub-assembly so that the sensor ID number and text is visible (Fig. 3-2).

STOP NOTE: Incorrect orientation of the pressure monitor sub-assembly may cause damage and prevent signal transmission during high-speed driving.

! (g) Install the washer on the outside of the wheel and secure it with the nut.

S Torque: 36 in-lbf (4.0 N-m)

4. Mount the Tires.

! **IMPORTANT:** If the vehicle came with 15 inch OE tires, reuse the OE 15 inch tires. In any case, use four P195/65R15 89S tires.

- (a) Use tire lube on the tire beads and bead locations on the wheel prior to mounting the tire.
- (b) Position the wheel on the mounting machine with the sensor at ~ 7 o'clock position (shaded area in Fig. 4-1).
 - (1) The mount/dismount head is considered as 12 o'clock.
- (c) Mount the lower tire bead.

STOP NOTE: If the sensor is positioned outside this area, it generates interference with the tire bead, causing possible damage to the sensor.

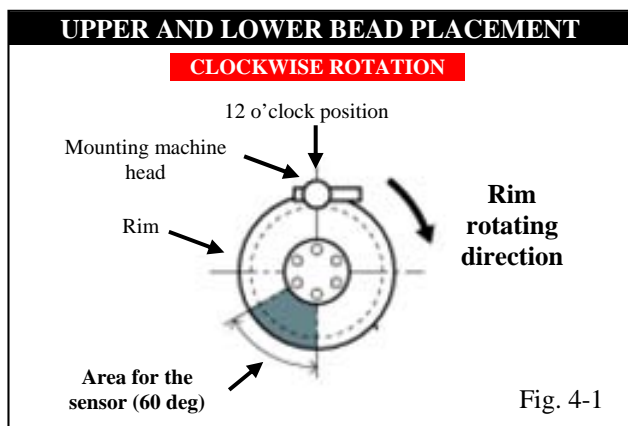

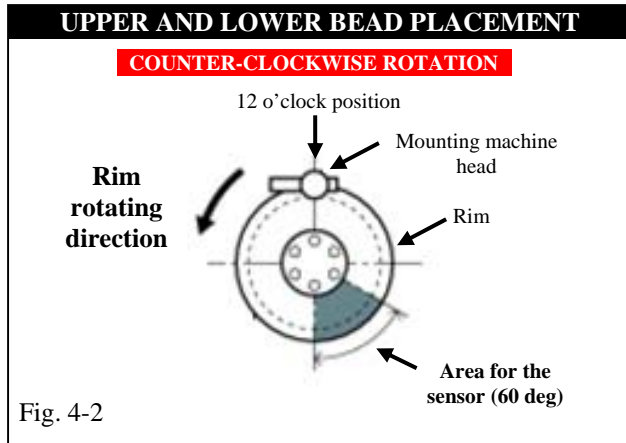

(d) Reposition the wheel on the mounting machine with the sensor at ~ 7 o'clock position (shaded area in Fig. 4-1).

(e) Mount the upper tire bead.

STOP NOTE: If the mounting machine rotates in the counterclockwise direction, refer to Fig. 4-2 for sensor placement.

STOP NOTE: Make sure that the tire bead and tool does not interfere with the main body of the sensor and the bead does not clamp sensor.

+ (f) To seat the tire beads, inflate the tire beyond 35 PSI (240 kPa) but not more than the maximum tire bead seat pressure indicated on the tire sidewall. If it is not indicated, use 40 PSI (275 kPa) as a limit. If both tire beads are not seated when the pressure registers 40 PSI (275 kPa), deflate the tire and re-inflate it to seat the beads.

(g) Install and torque the valve stem cores with the valve stem torque tool.

(h) Regulate the tire pressures to the OE tire pressure specified on the OE tire pressure label found on the driver side door jamb.

(i) Be sure to **recheck the torque** on the TPMS nuts.

S Torque: 36 in-lbf (4.0 N-m)

(j) Install the valve stem caps by hand.

5. Balance the Wheels.

 **NOTE:** Application temperature for stick-on type weight is above 50°F (10°C). It is good practice to apply the stick-on type in sections comprised of no more than 5 or 6 individual weight segments.

- (a) If new tires are being used, remove the tire labels from the tire tread.
- (b) Prior to mounting stick-on weight, use VDC-approved cleaner as needed to clean the weight mounting location on the wheel, then wipe down with a clean, dry, lint-free cloth. Ensure that the location is clean and dry. Apply stick-on type weights at the perimeter location identified by the dynamic balance machine, as shown. Use a rubber mallet, if required, to achieve complete adhesion of stick-on type weight(s).

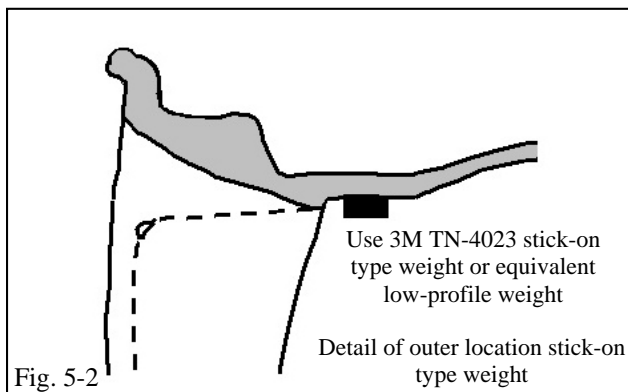
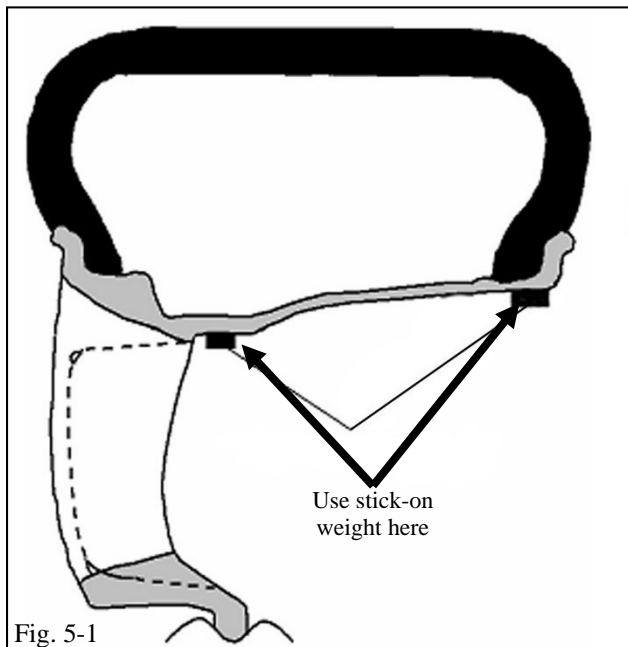

(c) Mount the wheel/tire on the wheel balance machine and balance in DYNAMIC MODE. Enable the LOAD ROLLER, if applicable, to ensure proper bead seating. Use **3M TN-4023** or equivalent lead-free stick-on type weights (Fig. 5-1 & Fig. 5-2).

⚠ NOTE: Weights should be no taller than 4 ~ 5 mm in height.

⚠ NOTE: The maximum allowable weight is **100 g** (3.5 oz.) on the inner plane and **100 g** (3.5 oz.) on the outer plane. If weight required exceeds this, place machine in STATIC mode and proceed. If weight required still exceeds limit, rotate tire 180 degrees relative to wheel and repeat Step 5(c). If removal and replacement of stick-on type weight is necessary, remove the weight using a nylon removal tool. Clean the surface with a clean cloth using a locally approved cleaning solution. Wipe the surface dry before re-applying new weight(s). **DO NOT RE-USE STICK-ON WEIGHTS.**

(d) Re-spin the wheel on the machine with the **LOAD ROLLER DISABLED** (if applicable) and note the indicated remaining unbalance. The maximum permitted unbalance is 6 g (0.21 oz.) at the inner location and 6 g (0.21 oz) at the outer location. If the indicated unbalance is not within the permissible limit, add required additional balance weights, within specification, and re-spin the tire/wheel assembly.

6. Record Tire Identification Numbers (TIN).

This step is not required if reusing the OE tires.

⚠ PPO Only – Record **ALL four** Tire Identification Numbers (TINs) if new tires are installed. Record these TINs with the Vehicle Identification Number (VIN) on respective form.

The TIN for these tires is an **11-** or **12-**character string located after the “DOT” symbol on the sidewall of the tire. Provide the tire information to TMS once per month via FAX. Refer to the **CAD PPO Bulletin** database as needed.

⚠ DIO Only – Record **ALL four** Tire Identification Numbers (TINs) if new tires are installed. Record these TINs with the Vehicle ID Number (VIN). Provide the tire information to your tire vendor as required by law.

7. Install the Center Caps.

⚠ (a) Install the caps into the wheels as shown in Fig. 7-1 & Fig. 7-2. Be sure to orient the Toyota logo relative to the valve hole (6 o'clock) as shown.





Fig. 8-1

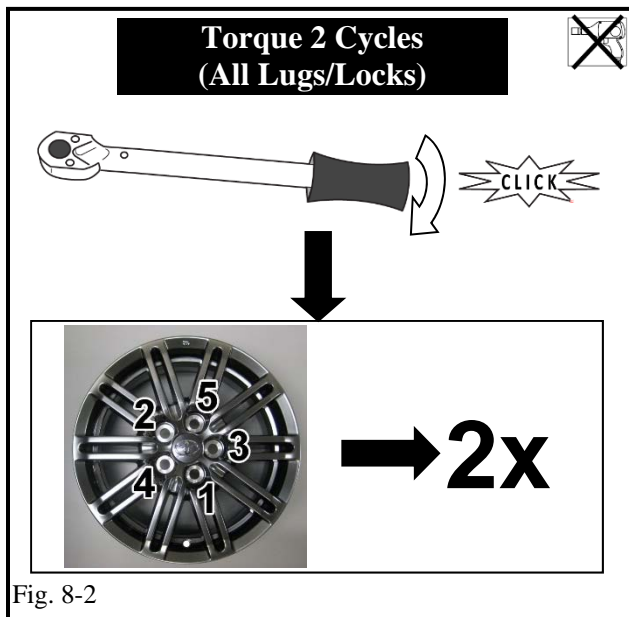

Fig. 8-2

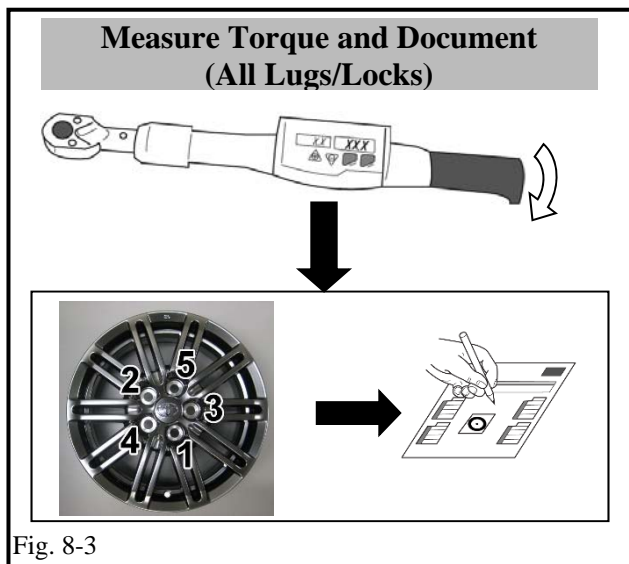

Fig. 8-3

8. Install the Wheels / Tires on the Vehicle.

! (a) Install the wheel/tire assemblies onto the vehicle. Hand start the lug nuts during installation. If wheel locks are being added, install one wheel lock per wheel at the right-hand (or the 3 o'clock) position as in Fig. 8-1.

(b) Tighten the lug nuts in sequence 1 through 5 or equivalent star pattern (Fig. 8-2). Ensure that the socket does not scuff the wheels. Tighten to 76 ft-lbf (103 N-m) using a torque wrench.

S Torque: 76 ft-lbf (103 N-m)

(c) Re-torque all lug nuts in the same 1-5 sequence (Fig. 8-2).

S Torque: 76 ft-lbf (103 N-m)

STOP CAUTION: DO NOT USE AN IMPACT WRENCH TO INSTALL OR REMOVE WHEEL LOCKS.

(d) With the vehicle still on the lift, use a digital torque wrench to measure the torque of each lug nut/lock and record it on the Torque Audit Sheet (Fig. 8-3) (PPO installation only, does not apply to DIO installation).

9. Tire Pressure Labels.

This wheel reuses the OE 15 inch tires, and therefore no accessory labels are required. Ensure that the vehicle has an OE 15 inch tire pressure label located on the driver's side door jamb.

10. TPMS Transmitter ID Registration Using Techstream.

⚠ NOTE: Perform ONLY when replacing sensors. Skip to Step 12 if the original 20-degree sensors are reused.

⚠ NOTE: Skip to Step 11 if a Techstream Device is used.

- (a) Complete this section after all four wheels have been installed.
- (b) Connect a hand-held tester to DLC3 (Fig. 10-1).
- (c) Turn the ignition switch to the ON position.

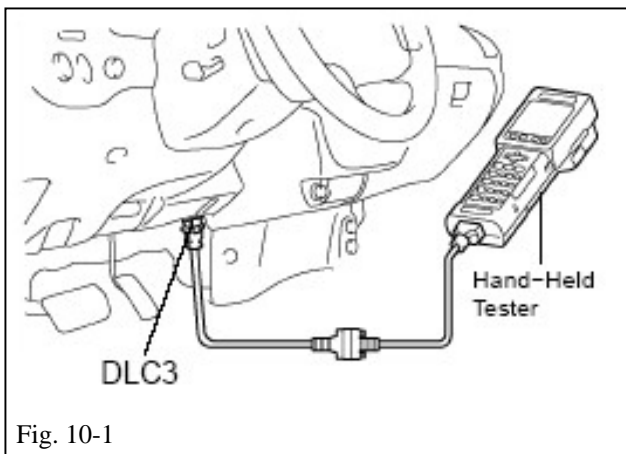

Fig. 10-1

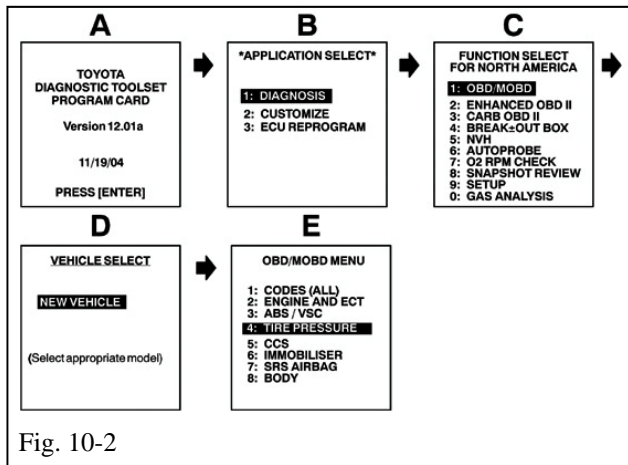

Fig. 10-2

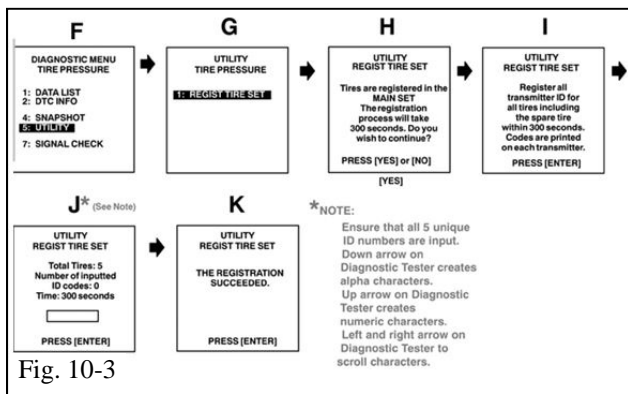

Fig. 10-3

- (d) Turn on the tester and select UTILITY - REGIST TIRE following the hand-held tester screen prompts (Fig. 10-2 & Fig. 10-3).
- (e) Input the TPMS ID codes (ID1 to ID4) from Step 3(b) using the hand-held tester to transmit them to the tire pressure monitor ECU.

NOTE: The spare tire does not have a TPMS.

- (f) Make sure that the ID transmission condition “SUCCEEDED” is achieved.
- (g) Confirm all the tire pressures are set to values recommended on the tire pressure label (Section 9) for this vehicle.

NOTE: If this process is not completed within 5 minutes, the transmitter will return to normal operation mode and the process will need to be started over at Step 10(d).

11. TPMS Transmitter ID Registration Using Techstream.

- (a) Connect the Techstream to DLC3.
- (b) Turn the ignition switch to the ON position (do not start the vehicle) then turn the Techstream ON.
- (c) Start the Techstream application by clicking on the shortcut located on the Desktop.

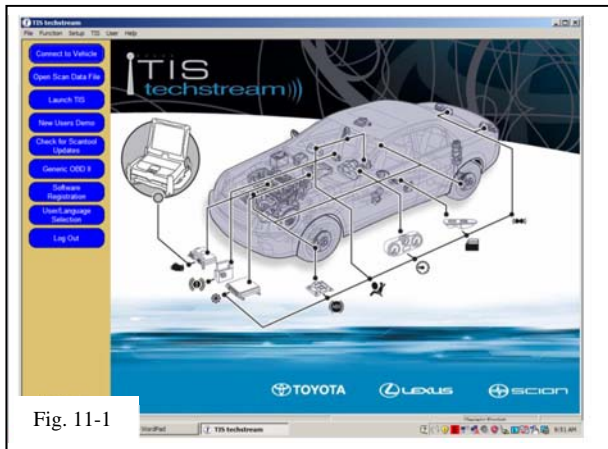

Fig. 11-1

(d) Click “**Connect to Vehicle**” button (Fig. 11-1).

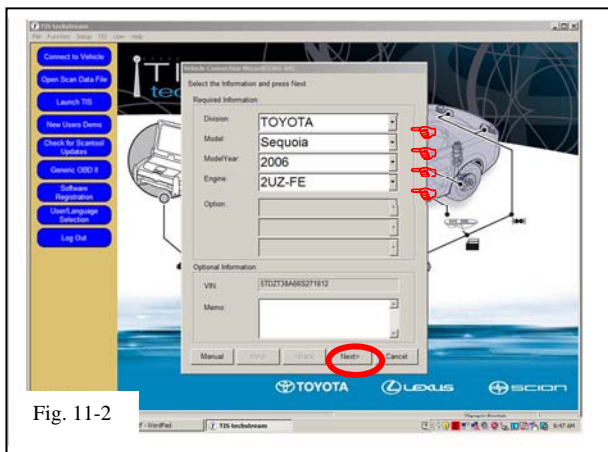

Fig. 11-2

(e) Confirm that the information displayed on the Vehicle Connection Wizard is correct. If not, make the appropriate selections from the drop down menus, then click “**Next**” (Fig. 11-2).

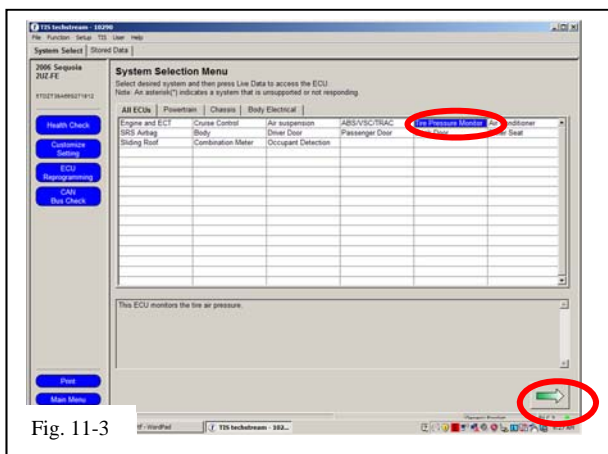

Fig. 11-3

(f) Select “**Tire Pressure Monitor**” then click the green arrow located on the bottom right (Fig. 11-3).

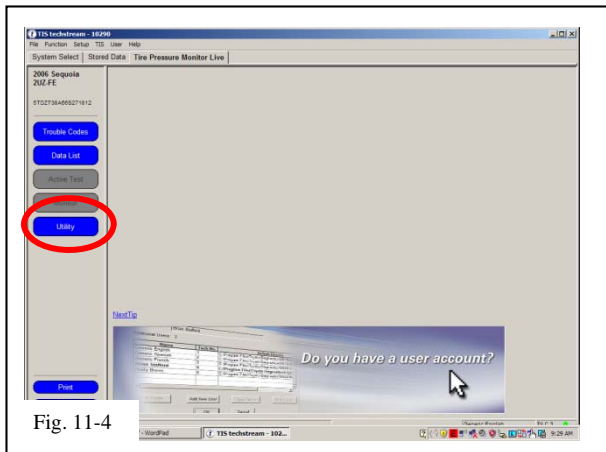

Fig. 11-4

(g) Select “UTILITY” to begin input of new TPMS ID codes (Fig. 11-4).

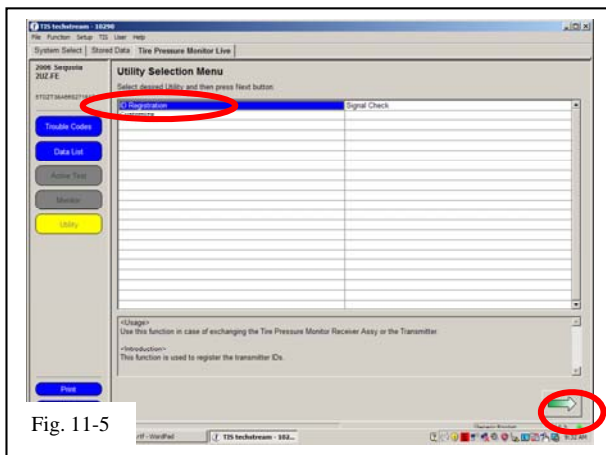

Fig. 11-5

(h) Select “ID Registration” then click the green arrow located at the bottom right corner (Fig. 11-5).

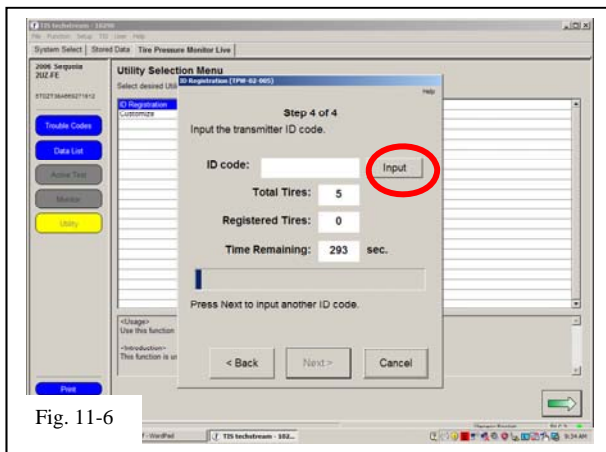

Fig. 11-6

(i) Select “Next” for Steps 1 through 3. Select “Input” in Step 4 to begin TPMS ID registration (Fig. 11-6).

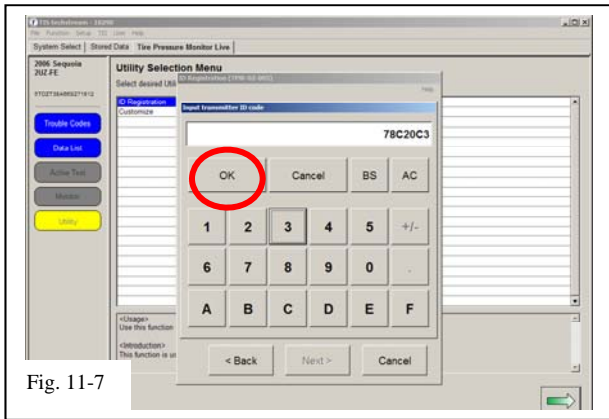

Fig. 11-7

- (j) Input the TPMS ID code then click “OK”
Repeat the same procedure for all other TPMS ID codes (Fig. 11-7).

NOTE: If this process is not completed within 5 minutes, the transmitter will return to normal operation mode and process will need to be started over at Step 11(g).

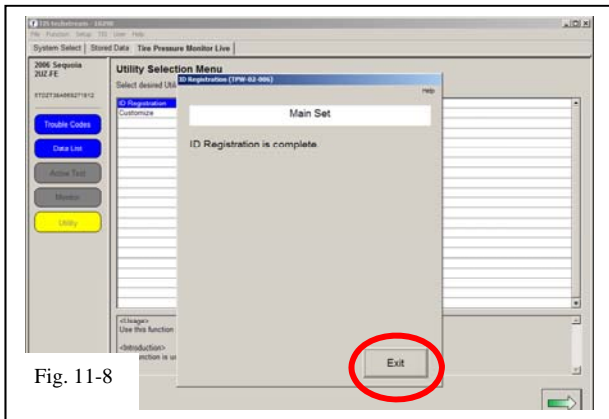

Fig. 11-8

- (k) After all TPMS ID numbers have been registered, “ID Registration is complete” text should be displayed. Click “Exit” to finish the registration process (Fig. 11-8).

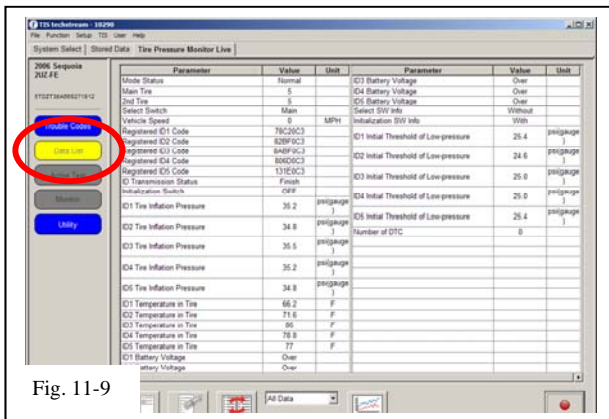

Fig. 11-9



- (l) Select “DATA LIST” to view and confirm the TPMS ID numbers have been correctly registered (Fig. 11-9).

12. Dispose of the OE Tire & Wheel Assembly.

PPO: All take-off tires get picked up by Dealer Tire. All take-off wheels get salvaged according to local regulations. Be sure to discard any OE wheel covers (check the hatch area).

DIO: Sort product properly according to local regulations.

Checklist - these points **MUST** be checked to ensure a quality installation.

Check:	Look For:
 <input type="checkbox"/> Inspect Lug Nuts & Torque	Verify that five lug nuts/locks are installed on each wheel and the optional wheel lock is in the correct position. Torque must be 76 ft-lbf (103 N-m) .
 <input type="checkbox"/> TPMS Torque	TPMS nut must be torqued to 36 in-lbf (4.0 N-m) .
<input type="checkbox"/> Record Lug & Lock Torque	Measure the torque of each lug/lock on all wheels and record it on the Torque Audit Sheet (PPO installation only, does not apply to DIO installation).
<input type="checkbox"/> Center Caps	Verify center caps are securely in place on all four wheels & oriented correctly.
<input type="checkbox"/> Tire Pressure Labels	Verify Tire Pressure Label and Owner's Manual Labels are in place.
 <input type="checkbox"/> Correct Tire Pressure	Verify tire pressure is set to the value specified on the OE 15" Tire Pressure Label.
<input type="checkbox"/> Driver Instrument Panel	Verify "TPMS warning light" is <u>not</u> ON.
<input type="checkbox"/> Tire Identification Numbers (Needed only if replacing the OE tires)	PPO: Ensure all 4 accessory Tire Identification Numbers are recorded with the Vehicle Identification Number on the Respective form. Refer to the CAD PPO Bulletin as needed. DIO: Provide the tire information to your tire vendor as required by law.
<input type="checkbox"/> Optional Wheel Lock Placement	Verify the Wheel Lock Key is in the appropriate location in the vehicle and the associated paperwork is placed into the vehicle glove compartment.

Vehicle Appearance Check

<input type="checkbox"/> After accessory installation and removal of protective cover(s), perform a visual inspection.	Ensure no damage (including scuffs and scratches) was caused during the installation process. (For PPO installations, refer to TMS Accessory Quality Shipping Standard.
--	--