

**Part Number: PT925-34222 (D-Cab),
PT925-34223 (C-Cab),
PT925-34224 (D-Cab),
PT925-34225 (C-Cab)**

Kit Contents

Item #	Quantity Req'd.	Description
1	1	Left Hand Step Tube
2	1	Right Hand Step Tube
3		

Hardware Bag Contents

Item #	Quantity Req'd.	Description
1		
2		
3		

Additional Items Required For Installation

Item #	Quantity Req'd.	Description
1		
2		
3		

Conflicts

None

Recommended Tools

Personal & Vehicle Protection	Notes
Special Tools	Notes
Installation Tools	Notes
12mm Socket	
Ratchet	
Torque Wrench	0-50 N-m (0-37 ft-lbf)
Special Chemicals	Notes

General Applicability

D-Cab & C-Cab Models

Recommended Sequence of Application

Item #	Accessory
1	
2	

*Mandatory

Vehicle Service Parts (may be required for reassembly)

Item #	Quantity Req'd.	Description
1	16	BOLT, w/ WASHER (90119-A0582)
2		
3		

Legend

 **STOP:** Damage to the vehicle may occur. Do not proceed until process has been complied with.

 **OPERATOR SAFETY:** Use caution to avoid risk of injury.

 **CAUTION:** A process that must be carefully observed in order to reduce the risk of damage to the accessory/vehicle and to ensure a quality installation.

 **TOOLS & EQUIPMENT:** Used in Figures calls out the specific tools and equipment recommended for this process.

 **REVISION MARK:** This mark highlights a change in installation with respect to previous issue.

 **SAFETY TORQUE:** This mark indicates that torque is related to safety.

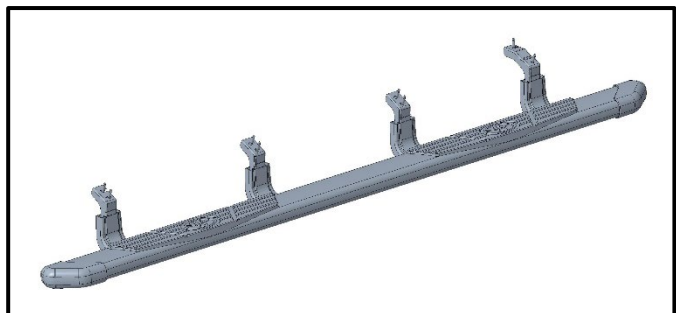

Care must be taken when installing this accessory to ensure damage does not occur to the vehicle. The installation of this accessory should follow approved guidelines to ensure a quality installation.

These guidelines can be found in the "Accessory Installation Practices" document.

This document covers such items as:-

- Vehicle Protection (use of covers and blankets, cleaning chemicals, etc.).
- Safety (eye protection, rechecking torque procedure, etc.).
- Vehicle Disassembly/Reassembly (panel removal, part storage, etc.).
- Electrical Component Disassembly/Reassembly (battery disconnection, connector removal, etc.).

Please see your Toyota dealer for a copy of this document.

1. Prepare for the Install.

- (a) Open the box and check the kit for complete contents and any damage.
- (b) Using a 12mm socket, remove 16 OE Hex bolts (90119-A0582 BOLT, W/WASHER) from underneath the vehicle, 8 per side (Fig. 1-1). Save them for later use.

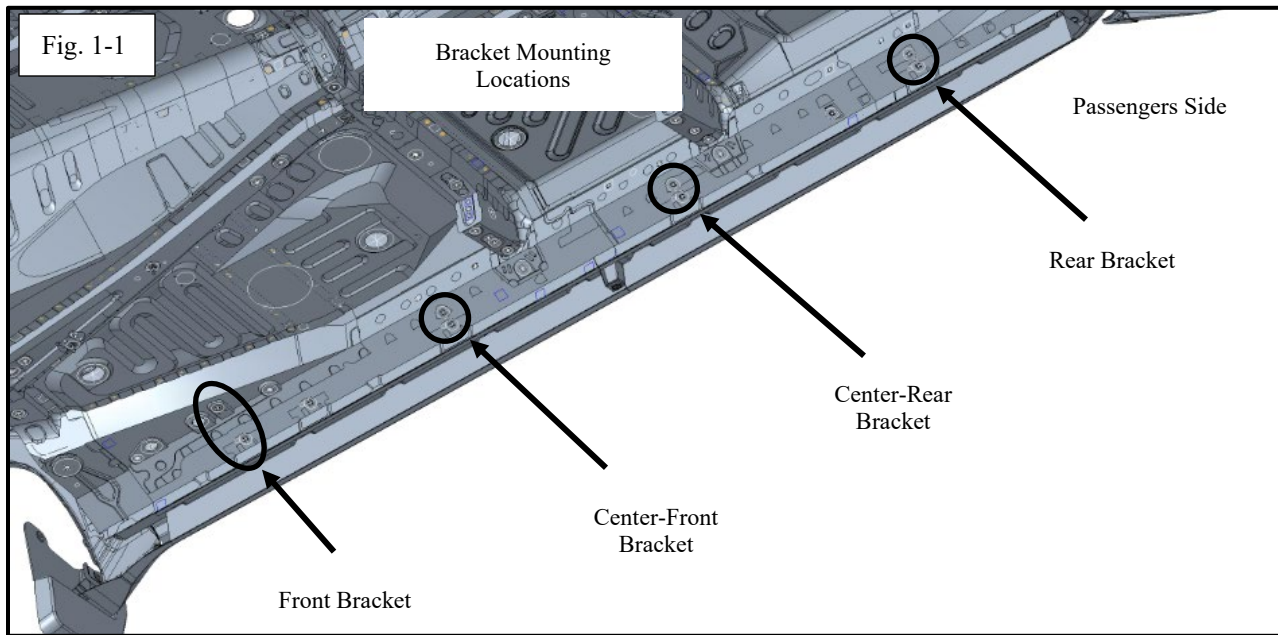

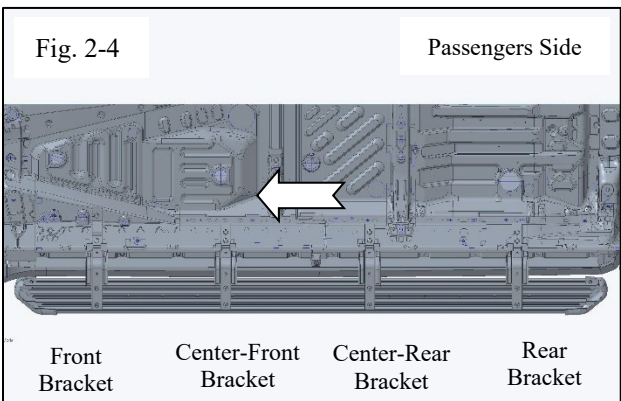
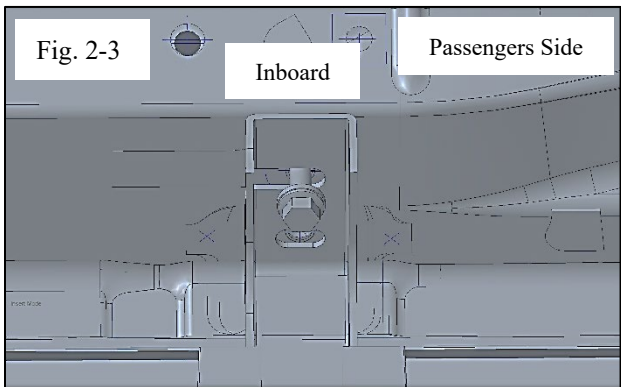
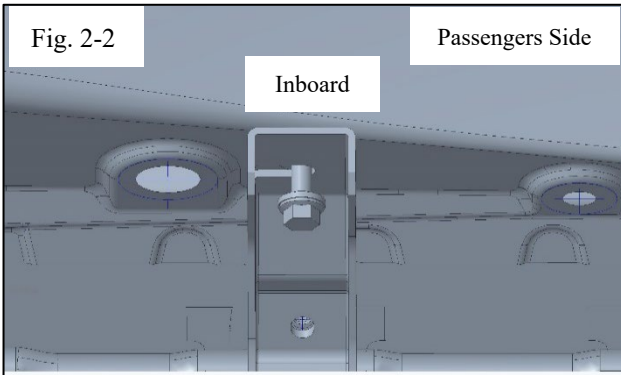
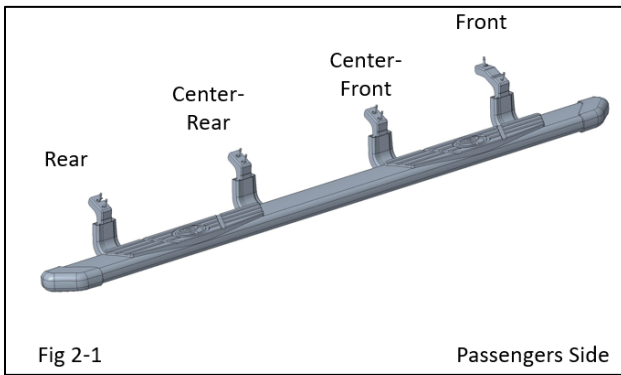

⚠ NOTE: For the following steps, the use of a non-impacting type electric hand tool can be used to drive the bolts so long as the bolt does not reach or exceed the specified torque. **Leave all hardware loose at this time.**

- (c) Hand start one previously removed 8mm bolt halfway into the inboard factory threaded hole on the front bracket location at least 4 threads (Fig. 2-2).
- (d) Hand start one previously removed 8mm bolt halfway into the inboard factory threaded hole on the rear most bracket location at least 4 threads (Fig. 2-3).
- (e) Hang board on pre-threaded bolts in Steps 2b and 2c
- (f) Hand start all remaining 8mm bolts at each bracket location (Fig. 2-2, 2-3, 2-4). Note: Leave hardware loose at this time.

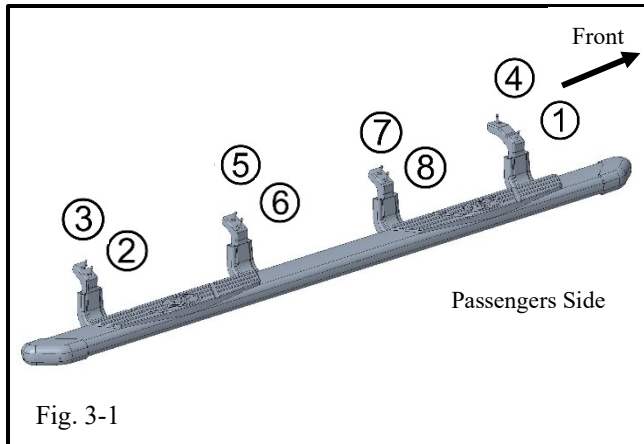

Fig. 3-1

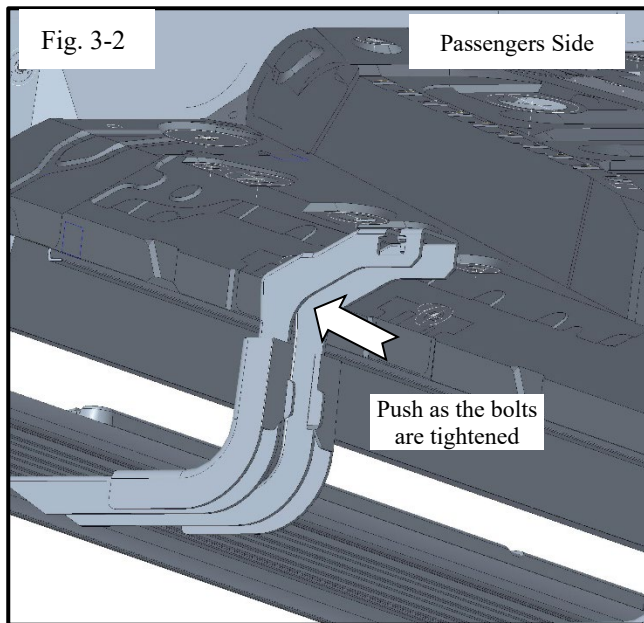

Fig. 3-2

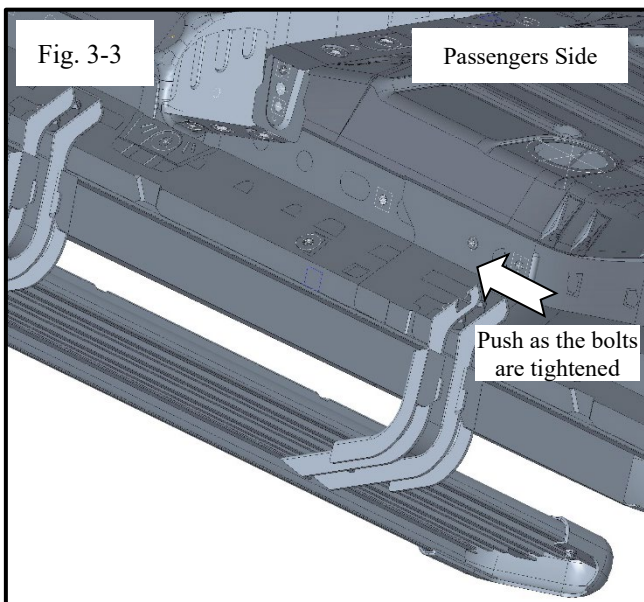

Fig. 3-3

2. Tighten all Hardware.

(a) In numerical order, tighten (but do not torque) the bolts as shown in Fig. 3-1.

⚠ NOTE: As the bolts closest to the pinch weld are tightened, push the bracket inward to maximize clearance to the pinch weld (Fig. 3-2 & 3-3).

(b) Tighten (but do not torque) the remaining bolts as indicated in Fig. 3-1.

3. Torque all Hardware.

(a) Follow the tightening sequence in Fig. 3-1 to torque the “outside bolts” ① through ④ .

Torque: 34 N-m (25.1 ft-lb)

(b) Follow the tightening sequence in Fig. 3-1 to torque the “inside bolts” ⑤ through ⑧ .

Torque: 34 N-m (25.1 ft-lbf)

4. Install the Driver Side Tube Step.

(a) Repeat Steps 2 through 4 on the driver side.

5. Re-torque all Hardware.

(a) Re-torque all sixteen (16) 8mm Hex Bolts in the same order as Step 3.

Torque: 34 N-m (25.1 ft-lb)

TOYOTA TUNDRA 2022 - FLAT OVAL STEP
 Checklist - these points **MUST** be checked to ensure a quality installation.

<u>Check:</u>	<u>Look For:</u>
<p><u>Accessory Function Checks</u></p> <ul style="list-style-type: none"> <input type="checkbox"/> Step alignment & torque <input type="checkbox"/> Inspect bolt torques <input type="checkbox"/> <input type="checkbox"/> 	<p>Torque: 34 N-m (25.1 ft-lb)</p> <p>Complete the torque audit sheet</p>
<p><u>Vehicle Function Checks</u></p> <ul style="list-style-type: none"> <input type="checkbox"/> No interference between step & vehicle <input type="checkbox"/> <input type="checkbox"/> 	<p>Pinch weld contact</p> <p>Cladding contact</p>
<p><u>Vehicle Appearance Check</u></p> <ul style="list-style-type: none"> <input type="checkbox"/> After accessory installation and removal of protective cover(s), perform a visual inspection. 	<p>Ensure no damage (including scuffs and scratches) was caused during the installation process. (For PPO installations, refer to TMNA Accessory Quality Shipping Standard.)</p>