

Section I - Installation Preparation

Part Number: PT427-48030

Section I - Installation Preparation

Kit Contents

Item #	Quantity Req.	Description
1	1	Hood protector
2	1	Hardware bag

Hardware Bag Contents

Item #	Quantity Req.	Description
1	2	"F" Clip Extrusion
2	2	10-32 x 1/4" Socket Setscrew
3	2	10-24 x 1/2" Machine Screw
4	2	10-24 K-Lock (Kep) Nut
5	2	Urethane Pad
6	1	3/32 " Short Arm Hex Key
7	2	Backing Plate
8	2	Nylon Fastener (2 piece)
9	1	DIO Instruction Sheet

Additional Items Required For Installation

Item #	Quantity Req.	Description

Conflicts

Note: Front End Mask

Recommended Tools

Safety Tools	
Vehicle Protection	Protective Blanket
Special Tools	
None	
Installation Tools	
Screwdriver	Phillips, #2
Wrench	3/8"
Tape Measure	
Special Chemicals	
Cleaner	3M™ Prep Solvent-70

General Applicability





All Highlanders from MY2001 onwards

Recommended Sequence of Application

Item #	Accessory	
1		
2		
3		

*Mandatory

Legend

	STOP: Damage to the vehicle may occur. Do not proceed until process has been complied with.
	OPERATOR SAFETY: Use caution to avoid risk of injury.
	CRITICAL PROCESS: Proceed with caution to ensure a quality installation.
	GENERAL PROCESS: This highlights specific processes to ensure a quality installation.
	TOOLS & EQUIPMENT: Calls out the specific tools and equipment recommended for this process.

Section II - Installation Procedure

A. Pre-Installation Preparation.

1. Inspect and verify the kit contents.
2. Open the hood.
3. Make sure front edge of hood, where the deflector is to be installed, is clean and free from dirt and/or debris. Use 3M™ Prep Solvent-70.

 i. When cleaning with 3M™ Prep Solvent-70 follow the manufacturer's directions. Do not allow cleaner to air dry.

-  4. Cover engine bay completely with a protective blanket to catch any dropped hardware.
5. Remove entire protective film from shield and discard film.

B. Prepare the Deflector for Installation.

 1. Remove the two (2) weather strip fasteners shown in Fig. B-1, and discard fasteners.

C. Install the Shield Assembly to the Vehicle.

1. Line up shield with the existing holes in the hood, making sure the shield is centered. Shield is installed between weather strip and hood. (Fig C-1)
 - i. For easier installation, remove the pin from the insert. (Fig. C-2)
 - ii. Install the insert through the weather-strip and shield, and into the hood. (Fig. C-3)
 - iii. Push pin into insert. (Fig. C-3)

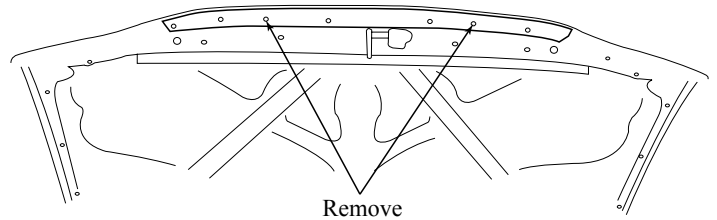

Fig. B-1

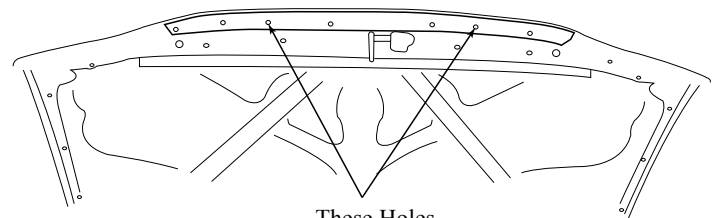

Fig. C-1



Fig. C-2

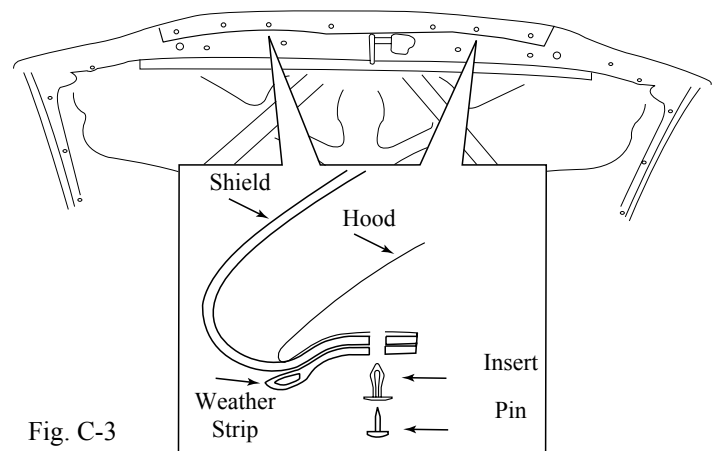
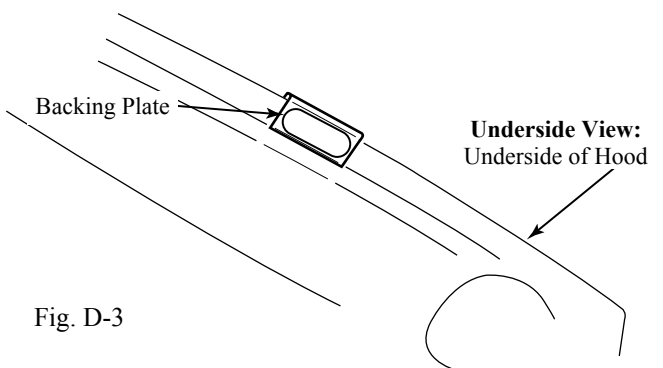
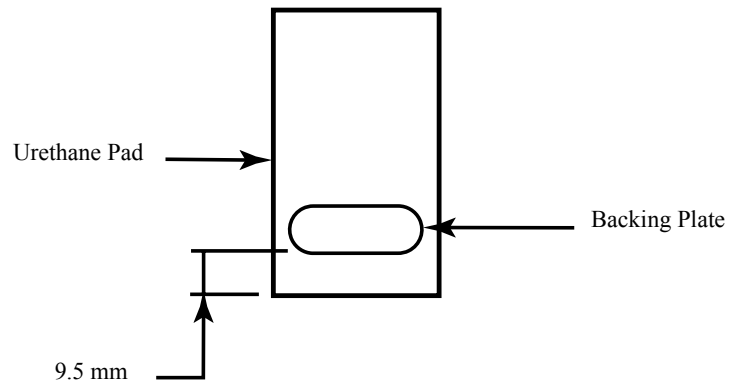
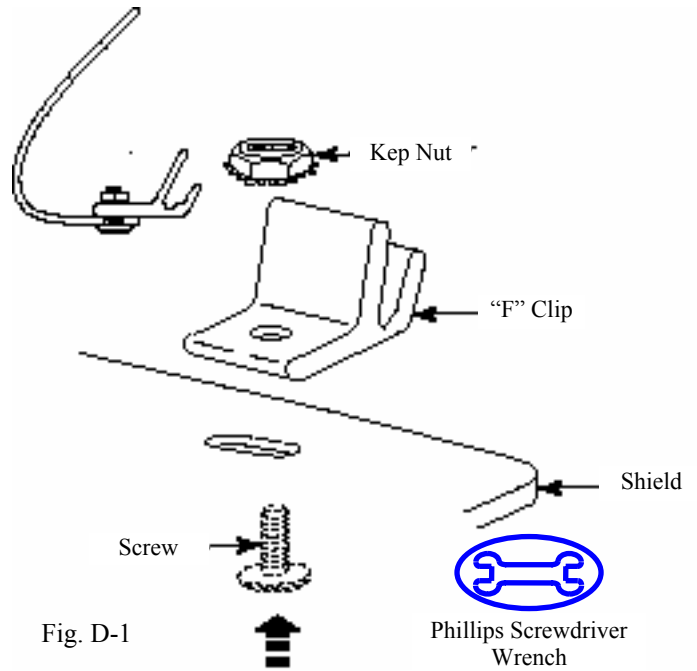

Fig. C-3

D. Install End Brackets to the Shield.

1. Attach the two "F" clips to the outer slots in the shield. Fig. D-1
2. Using a Phillips screwdriver and a 3/8 " wrench, tighten the kep nut to the 1/2 " screw. Tighten screws. (Fig. D-1)
3. Apply the two (2) small urethane pads to the hood in area where end brackets are to be installed.

- ➔ i. Apply backing plate approximately 9½ mm (3/8") from the bottom edge of the urethane pad. (Fig. D-2)
- ➔ ii. Urethane should be centered to brackets. Wrap urethane pad around the edge of the hood and press firmly. (Fig.s D-3 & D-4)
- ⚠ iii. There should be no direct contact of end brackets to hood.





Section II - Installation Procedure

4. Line up "F" clips with the urethane pad.

 i. Slide the clip over the hood and center on urethane pad.

 ii. Make sure clip is all the way up to the lip of the hood. (Fig. D-5)

 iii. Once shield is centered, tighten 1/4" setscrews that attach the clip to the hood with the short arm hex key. (Fig. D-5)

 5. Firmly tighten the two (2) 1/2" (10-24) shield retaining screws.

6. Close the hood.

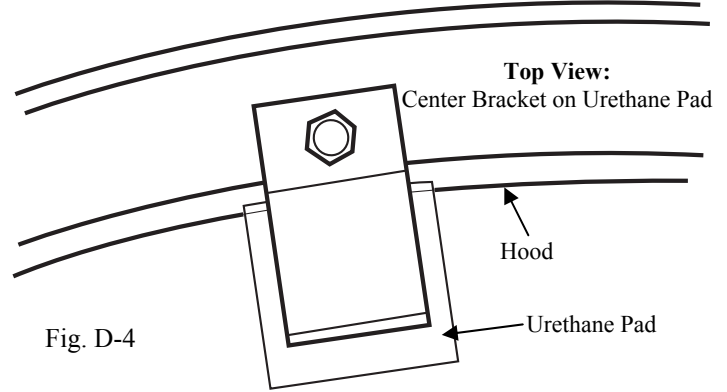

Fig. D-4

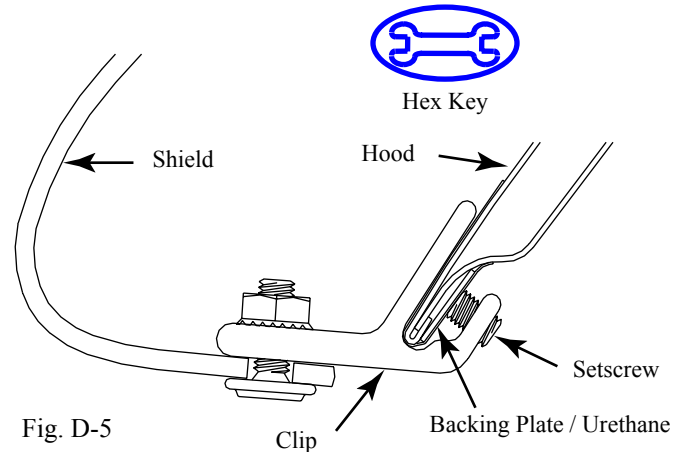

Fig. D-5

Section III - Functional Verifications



Section III - Functional Verifications

Check: _____

Hood closure.

Clearance of hood protector to hood.

Look For: _____

Hood brackets should not contact the headlights.

The hood protector (shield) should not contact the grill.