

Part Number: PT37A-21111 (for M/T)

Kit Contents

Item #	Quantity Reqd.	Description
1	1	Shift Knob
2		with base adaptor attached
3		
4		
5		

Hardware Bag Contents

Item #	Quantity Reqd.	Description
1	1	Shift Pattern Decal for MT
2		
3		

Additional Items Required For Installation

Item #	Quantity Reqd.	Description
1		
2		
3		

Conflicts

--

Recommended Tools

Personal & Vehicle Protection	Notes
Working gloves	
Special Tools	Notes
None	
Installation Tools	Notes
Versa-Grip strap wrench	
Clean terry cloth	
Special Chemicals	Notes
VDC approved cleaner	

General Applicability

tC M/T only

Recommended Sequence of Application





Item #	Accessory
1	
2	
3	

*Mandatory

Vehicle Service Parts (may be required for reassembly)

Item #	Quantity Reqd.	Description
1		
2		
3		

Legend

	STOP: Damage to the vehicle may occur. Do not proceed until process has been complied with.
	OPERATOR SAFETY: Use caution to avoid risk of injury.
	CAUTION: A process that must be carefully observed in order to reduce the risk of damage to the accessory/vehicle and to ensure a quality installation.
	TOOLS & EQUIPMENT: Used in Figures calls out the specific tools and equipment recommended for this process.
	REVISION MARK: This mark highlights a change in installation with respect to previous issue.

Care must be taken when installing this accessory to ensure damage does not occur to the vehicle. The installation of this accessory should follow approved guidelines to ensure a quality installation.

These guidelines can be found in the "Accessory Installation Practices" document.

This document covers such items as:-

- Vehicle Protection (use of covers and blankets, cleaning chemicals, etc.).
- Safety (eye protection, rechecking torque procedure, etc.).
- Vehicle Disassembly/Reassembly (panel removal, part storage, etc.).
- Electrical Component Disassembly/Reassembly (battery disconnection, connector removal, etc.).

Please see your Toyota dealer for a copy of this document.

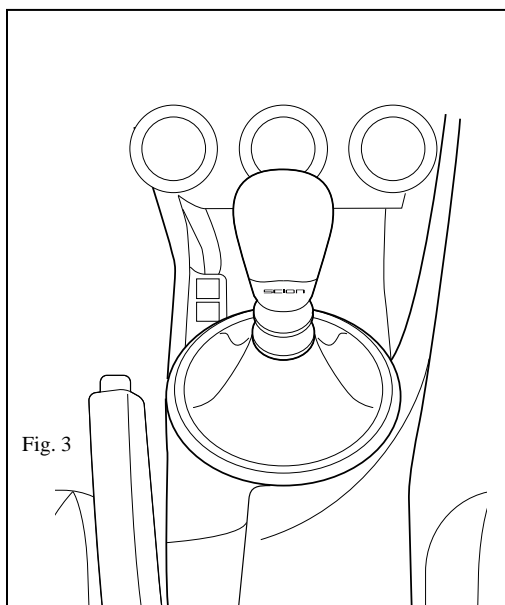
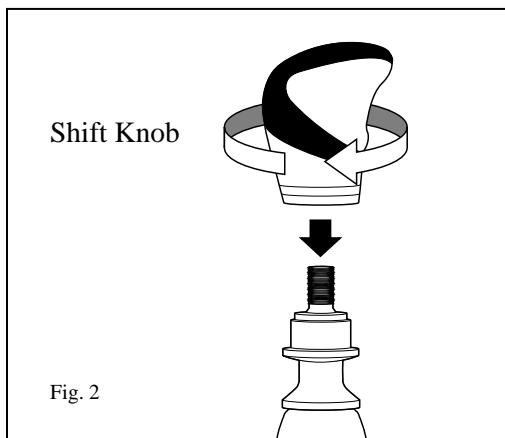
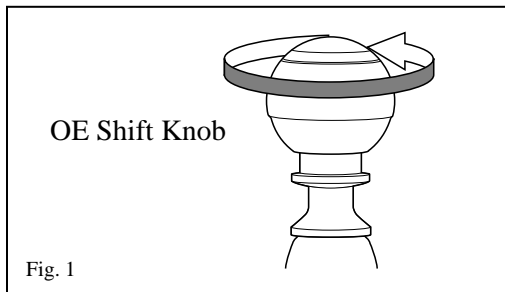

1. Pre-Installation Precautions



(a) Make sure vehicle is on a flat surface and not on an incline/decline. Position the gear lever in Neutral. (MT)



(b) Engage Parking Brake.

2. Remove OE Shift Knob

(a) Turn the OE shift knob counter-clockwise to loosen, then remove and discard. (Fig. 1)

3. Install Shift Knob

(a) Lower shift knob onto shift rod. Apply slight downward pressure while turning clockwise about 6 rotations to achieve snug fit. (Fig. 2)

(b) Adjust shift knob so the logo is aligned with front seats. (Fig.3)



NOTE: The first 4 to 5 turns on the inner sleeve is pre-threaded, so initial effort will be easier. Operator should feel a difference in pressure after that. After achieving snug fit, turn the shift knob at least 180 degrees more.



NOTE: DO NOT over-tighten! Damage to Inner Sleeve may occur. If shift knob tightness is unsatisfactory after 6 turns, give one more full turn. DO NOT exceed 8 turns!

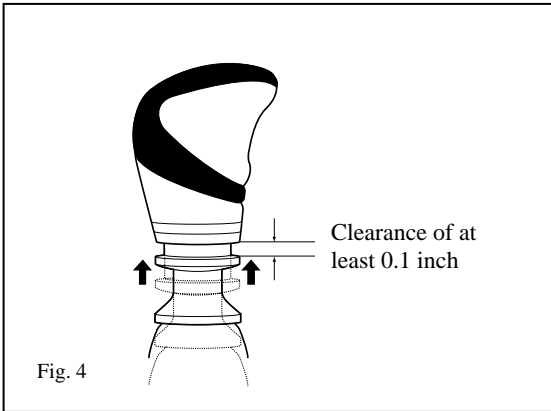

NOTE: Lift Reverse Ring and engage transmission in Reverse to make sure the operation is performed smoothly.

A clearance of at least 0.1 inch should exist between bottom of the Shift Knob and top of the Reverse Ring when it is lifted. (Fig. 4)

4. Apply Shift Pattern Badge (M/T only)

- (a) Locate the area for Shift Pattern Badge on the shift console.
- (b) Clean console surface with VDC approved Cleaner and wipe dry with a clean terry cloth.



NOTE: Do not touch or allow debris or contaminants to come into contact with the surface after cleaning.

- (c) Remove tape liner on bottom of badge and apply firmly onto selected location. (Fig. 4)



NOTE: The shift knob can become extremely hot when the vehicle is parked under direct sunlight. Please be mindful of this and take necessary precautions.

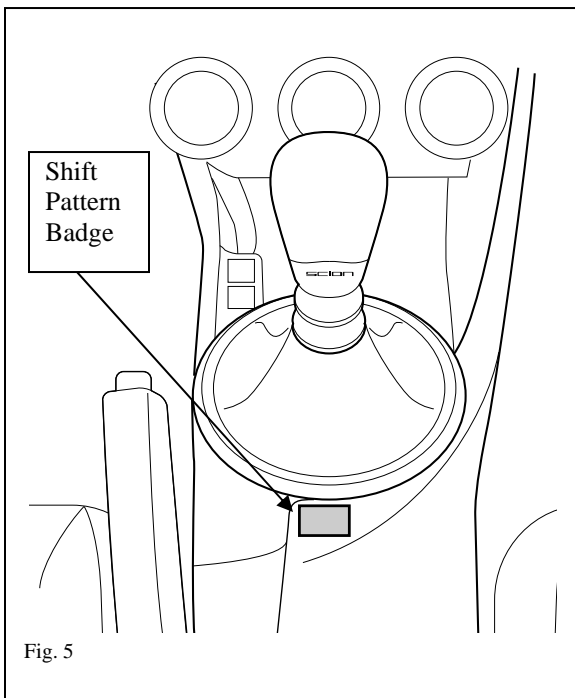

Checklist - these points **MUST** be checked to ensure a quality installation.

Check:

Look For:

Accessory Function Checks

Shift Pattern Decal

Make sure the decal is affixed on the correct location and properly aligned.

Vehicle Function Checks

 Sport Shift Knob to Shaft

Shift knob is securely installed with no vertical or rotational movement.

Shift knob allows full range of motion through all gears.