

**Part Number: PT347-42130**

**NOTE:** Part number of this accessory may not be the same as the part number shown.

**Kit Contents**

Item #	Quantity Reqd.	Description
1	1	Convenience Net







**Vehicle Service Parts** (may be required for reassembly)

Item #	Quantity Reqd.	Description

**Hardware Bag Contents**

Item #	Quantity Reqd.	Description

**Legend**

	<b>STOP:</b> Damage to the vehicle may occur. Do not proceed until process has been complied with.
	<b>OPERATOR SAFETY:</b> Use caution to avoid risk of injury.
	<b>CAUTION:</b> A process that must be carefully observed in order to reduce the risk of damage to the accessory/vehicle and to ensure a quality installation.
	<b>TOOLS &amp; EQUIPMENT:</b> Used in Figures calls out the specific tools and equipment recommended for this process.
	<b>REVISION MARK:</b> This mark highlights a change in installation with respect to previous issue.
	<b>SAFETY TORQUE:</b> This mark indicates that torque is related to safety.

**Additional Items Required For Installation**

Item #	Quantity Reqd.	Description

**Conflicts**

None
------

**Recommended Tools**

<b>Personal &amp; Vehicle Protection</b>	<b>Notes</b>
None	
<b>Special Tools</b>	<b>Notes</b>
None	
<b>Installation Tools</b>	<b>Notes</b>
None	
<b>Special Chemicals</b>	<b>Notes</b>
None	

**General Applicability**

Models <b>Without</b> Sub-woofer
----------------------------------

**Recommended Sequence of Application**

Item #	Accessory

\*Mandatory

Care must be taken when installing this accessory to ensure damage does not occur to the vehicle. The installation of this accessory should follow approved guidelines to ensure a quality installation.

These guidelines can be found in the "Accessory Installation Practices" document.

This document covers such items as:-

- Vehicle Protection (use of covers and blankets, cleaning chemicals, etc.).
- Safety (eye protection, rechecking torque procedure, etc.).
- Vehicle Disassembly/Reassembly (panel removal, part storage, etc.).
- Electrical Component Disassembly/Reassembly (battery disconnection, connector removal, etc.).

Please see your Toyota dealer for a copy of this document.

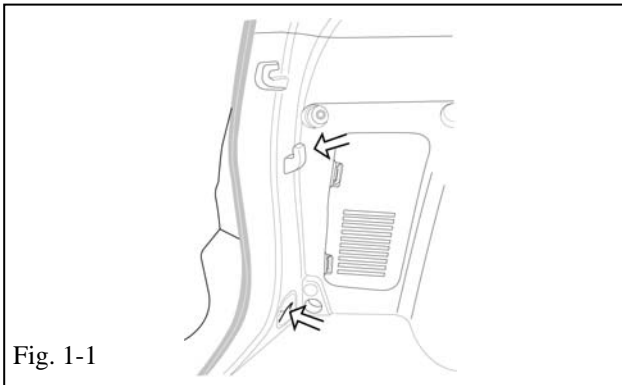

Fig. 1-1

### 1. Installation of Cargo Net.

- (a) Open hatch, locate anchor locations on the driver's side of the vehicle (Fig 1-1.)
- (b) Cover rear bumper and rear cargo area with blankets or protective cover(s).
- (c) Attach loop at the top of the net to the vehicle hook on the vehicle as shown (Fig. 1-2).
- (d) Attach hook at the bottom of the net to the D-ring on the vehicle as shown (Fig. 1-3).

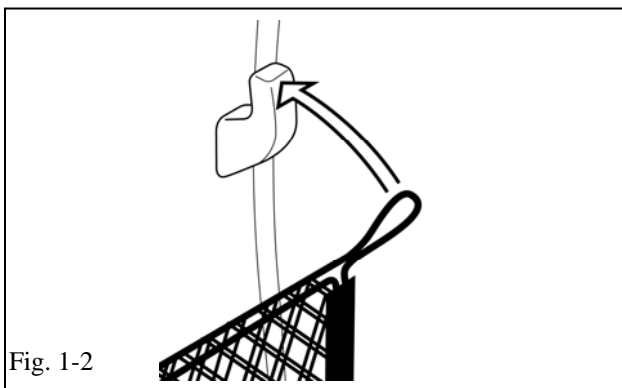

Fig. 1-2

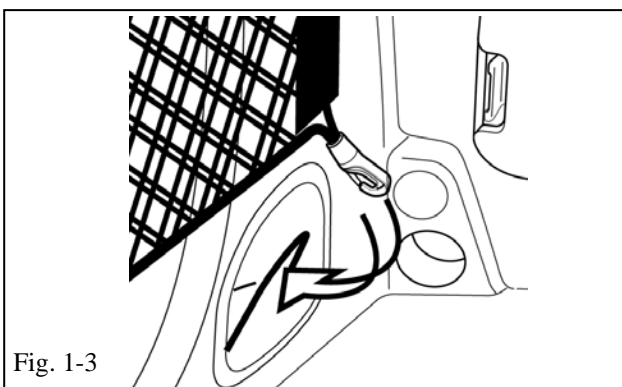
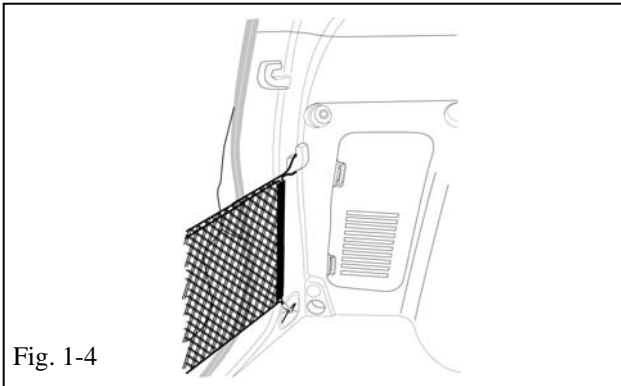

Fig. 1-3



(e) Review driver's side attachment (Fig. 1-4).

(f) Repeat steps 1(a) through 1(d) for the passenger's side of the vehicle.



(g) Confirm completed assembly. Make sure net handle is facing out toward the rear of the vehicle (Fig. 1-5).

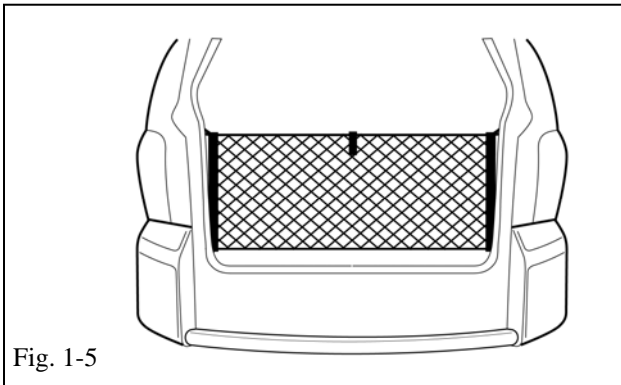

Checklist - these points **MUST** be checked to ensure a quality installation.

<u>Check:</u>	<u>Look For:</u>
<p><u>Accessory Function Checks</u></p> <p><input type="checkbox"/> Confirm that the net is attached properly to the anchor points in the vehicle.</p>	<p>Make sure hooks are attached to floor D-rings and the loops are attached to the vehicle hooks at the top, and the net handle is facing out toward the rear of the vehicle.</p>
<p><u>Vehicle Function Checks</u></p> <p><input type="checkbox"/> Vehicle door operation</p>	<p>Confirm vehicle door open and closes without interference from Cargo Net.</p>
<p><u>Vehicle Appearance Check</u></p> <p><input type="checkbox"/> After accessory installation and removal of protective cover(s), perform a visual inspection.</p>	<p>Ensure no damage (including scuffs and scratches) was caused during the installation process. (For PPO installations, refer to TMS Accessory Quality Shipping Standard.)</p>