

**Part Number: PT278-02080**

**Kit Contents**

Item #	Quantity Reqd.	Description
1	1	Bumper Protector
2	1	Installation Instruction Sheets
3	1	Paper Template Sheet
4		
5		
6		

**Hardware Bag Contents**

Item #	Quantity Reqd.	Description
1		
2		
3		
4		

**Additional Items Required For Installation**

Item #	Quantity Reqd.	Description
1		
2		
3		

**Conflicts**

--

**Recommended Tools**

<b>Personal &amp; Vehicle Protection</b>	<b>Notes</b>
Safety Glasses	
Vehicle Protection	Seat & Floor Covers
<b>Special Tools</b>	<b>Notes</b>
Roller	Hard Rubber or Wood Hand Roller, 1" to 3" wide.
<b>Installation Tools</b>	<b>Notes</b>
Scissors / Utility Knife	Paper Scissors or Sharp X-Acto Knife
Masking Tape	1" wide
Clean Lint-free Cloths	
<b>Special Chemicals</b>	<b>Notes</b>
Cleaner	3M™ Prep Solvent-70

**NOTE:** Part number of this accessory may not be the same as the part number shown.

**General Applicability**

Rear Bumper Protector can be installed on all Corolla Models
--

**Recommended Sequence of Application**





Item #	Accessory
1	Rear Bumper Protector – Can be installed in any sequence with other accessories

\*Mandatory

**Vehicle Service Parts** (may be required for reassembly)

Item #	Quantity Reqd.	Description

**Legend**

	<b>STOP:</b> Damage to the vehicle may occur. Do not proceed until process has been complied with.
	<b>OPERATOR SAFETY:</b> Use caution to avoid risk of injury.
	<b>CAUTION:</b> A process that must be carefully observed in order to reduce the risk of damage to the accessory/vehicle and to ensure a quality installation.
	<b>TOOLS &amp; EQUIPMENT:</b> Used in Figures calls out the specific tools and equipment recommended for this process.
	<b>REVISION MARK:</b> This mark highlights a change in installation with respect to previous issue.

**Section II - Installation Procedure**

Care must be taken when installing this accessory to ensure damage does not occur to the vehicle. The installation of this accessory should follow approved guidelines to ensure a quality installation.

These guidelines can be found in the "Accessory Installation Practices" document.



This document covers such items as:-

- Vehicle Protection (use of covers and blankets, cleaning chemicals, etc.).
- Safety (eye protection, rechecking torque procedure, etc.).
- Vehicle Disassembly/Reassembly (panel removal, part storage, etc.).
- Electrical Component Disassembly/Reassembly (battery disconnection, connector removal, etc.).

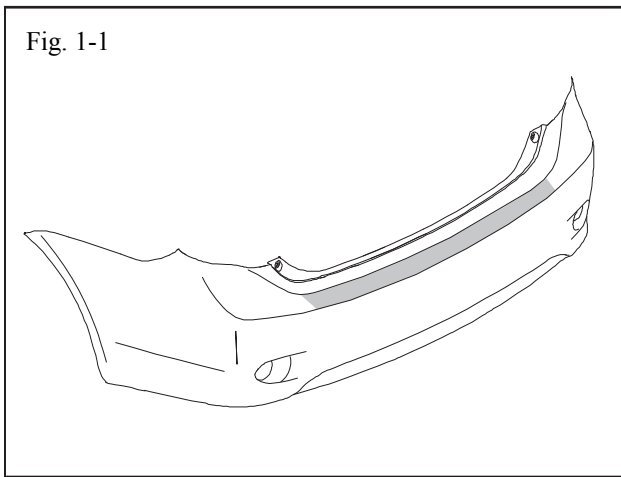
Please see your Toyota dealer for a copy of this document.



**1. Vehicle Preparation**

-  (a) Before working on the vehicle, protect the seats and carpets with covers.
-  (b) The work area, protector and vehicle bumper surface temperature must be at least 60°F.
- (c) Open the rear lift gate.
- (d) Saturate a clean lint-free cloth with 3M™ Prep Solvent-70 and scrub the top surface of the rear bumper as shown in Fig. 1-1.

 (1) When cleaning with 3M™ Prep Solvent-70 follow the manufacturer’s directions. Do not allow cleaner to air dry.

(e) Wipe the scrubbed bumper surface with a clean, dry, lint-free cloth.

 **NOTE:** Once cleaned do not contaminate this surface by touching it with your bare hands.

**2. Template Mounting**

- (a) Using a pair of paper cutting scissors or a sharp X-Acto knife, carefully cut out the three paper templates.
- (b) Fold template “A”, “B” and “C” where noted and tape them in place as shown in Fig. 2-1.

 (1) The cut out holes in templates “A” and “C” are to be center over the bumper mounting screws pockets.

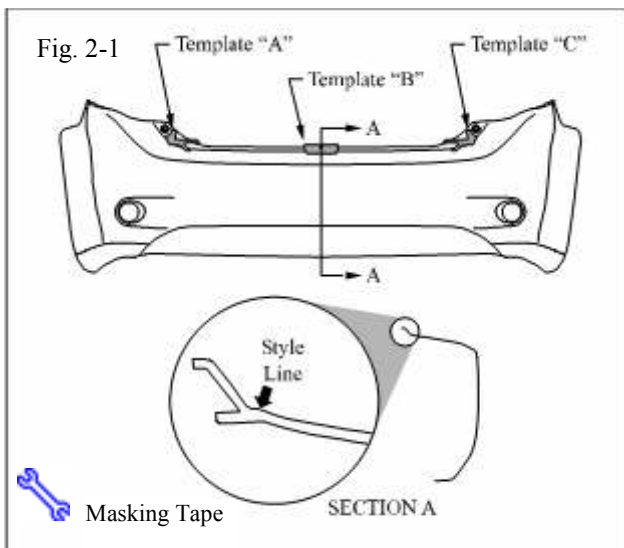

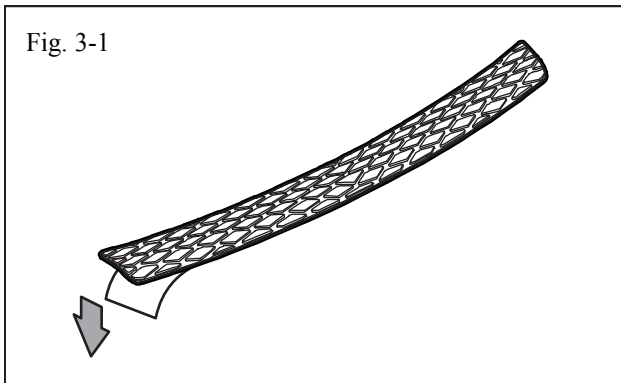



### 3. Bumper Protector Installation.

-  (a) While carefully holding the bumper protector by its edges, pull the plastic tape at the end of the part to remove the release liner from the acrylic foam tape. (Fig. 3-1)

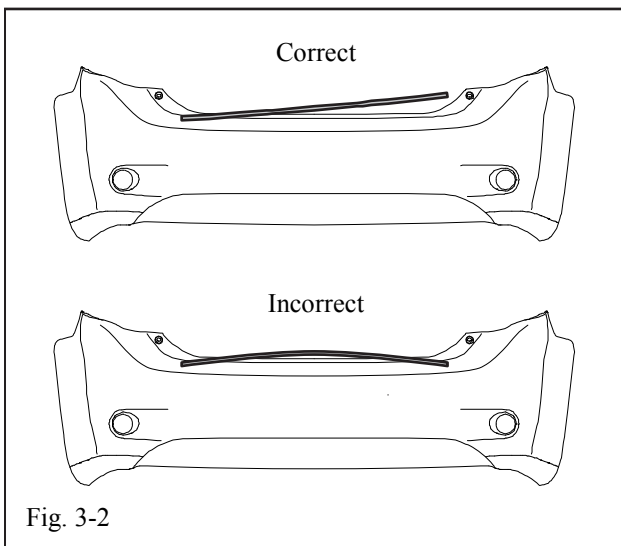
 NOTE: Once the release liner is removed from the bumper protector, the surface of the foam tape must not be touched!





-  (b) Hold the bumper protector about 1/2" above the surface of the bumper and align the left hand corner with the notch in template "A" and the forward edges of the bumper protector with the rear edges of templates "B" and "C".

 NOTE: Assure bumper protector does not sit on top of style line. (Fig. 2-1)

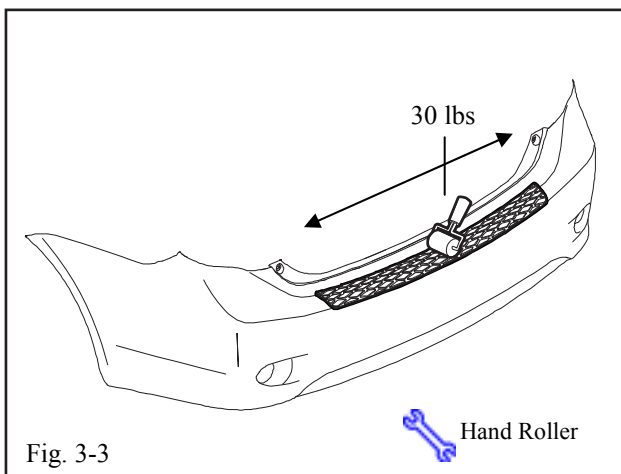
-  (c) While keeping the bumper protector aligned, lower the left-hand corner until it contacts the bumper and starts to stick. Using a rolling motion, lower the rest of the bumper protector to the bumper from left to right. Do not allow both ends of the bumper protector to stick to the bumper before the center touches. (Fig. 3-2)



-  (d) Using the hand roller, roll around the perimeter of the part with at least 30 lbs. of pressure to ensure complete adhesion of the acrylic foam tape to the bumper surface. (Fig. 3-3)

-  (e) Remove and discard templates

**TOYOTA COROLLA 2009- REAR BUMPER PROTECTOR**  
Checklist - these points **MUST** be checked to ensure a quality installation.

Check:

Accessory Function Checks

Check visual alignment

Check for proper tape adhesion.

Look For:

Bumper protector should be visually centered left to right.

The rear edge of the bumper protector should appear visually parallel to the rear edge of the vehicle bumper.

The bumper protector should not extend back out over the rear of the bumper where the bumper surface starts to transition to vertical surfaces.

A gap of approximately ½ mm is designed to exist between the edges of the bumper protector and the bumper.

No gap is allowed between the tape and the bumper

Vehicle Function Checks

None Required