

Preparation

Part Number: 08586-53810

NOTE: Part number of this accessory may not be the same as the part number shown.

Kit Contents

Item #	Quantity Req'd.	Description
1	1	V3 ECU
2	1	Piezo Buzzer
3	1	Wire Harness
4	1	ECU Mounting Bracket
5	2	Remote Control Transmitter
6	1	Butyl Tape
7	1	Status Monitor

Hardware Bag Contents

Item #	Quantity Req'd.	Description
1	1	Grommet
2	2	Splicing Connectors
3	1	Bolt
4	1	Screw
5	2	Large Foam Tapes
6	4	Small Foam Tapes
7	30	Wire Ties
8	2	Window Labels
9	1	Key Tag
10	1	Owner's Manual
11	1	Warranty Card

Additional Items Required For Installation

Item #	Quantity Req'd.	Description
1	1	Electrical Tape

Conflicts

Note: Do not install in vehicle with factory keyless entry.

Recommended Tools

Personal & Vehicle Protection	Notes
Safety Glasses	
Safety Gloves	(Optional)
Vehicle Protection	Blankets, Part Boxes
Special Tools	Notes
Cable Wire Routing Tool (PPO Only)	
Wiring Terminal Tool (PPO Only)	CAD-E IADS P/N ALL 02-016-03
Striker Tool	CAD-E IDAS P/N ALL 02-016-01
Installation Tools	Notes
Phillips Head Screwdriver	#2, screwdriver or tip
Screwdriver	Flat Blade, Jeweler's
Socket	10mm, Extension

Nylon Panel Removal Tool	e.g. Panel Pry Tool #1 Toyota SST # 00002-06001-01
Pneumatic/Electric Wrench	
Side Cutters	
Torque Wrench	36 in-lbf. ± 1.5.
Pliers	
Wrench	10mm
Utility Knife	
Special Chemicals	Notes
Glass Cleaner	Household Windex

General Applicability

Note: YARIS HATCHBACK with power door locks only.

Recommended Sequence of Application





Item #	Accessory	

*Mandatory

Vehicle Service Parts (may be required for reassembly)

Item #	Quantity Req'd.	Description

Legend

	STOP: Damage to the vehicle may occur. Do not proceed until process has been complied with.
	OPERATOR SAFETY: Use caution to avoid risk of injury.
	CAUTION: A process that must be carefully observed in order to reduce the risk of damage to the accessory/vehicle and to ensure a quality installation.
	TOOLS & EQUIPMENT: Used in Figures calls out the specific tools and equipment recommended for this process.

Procedure

Care must be taken when installing this accessory to ensure damage does not occur to the vehicle. The installation of this accessory should follow approved guidelines to ensure a quality installation.

These guidelines can be found in the "Accessory Installation Practices" document.

This document covers such items as:-

- Vehicle Protection (use of covers and blankets, cleaning chemicals, etc.).
- Safety (eye protection, rechecking torque procedure, etc.).
- Vehicle Disassembly/Reassembly (panel removal, part storage, etc.).
- Electrical Component Disassembly/Reassembly (battery disconnection, connector removal, etc.).

Please see your Toyota dealer for a copy of this document

1. Vehicle Disassembly.

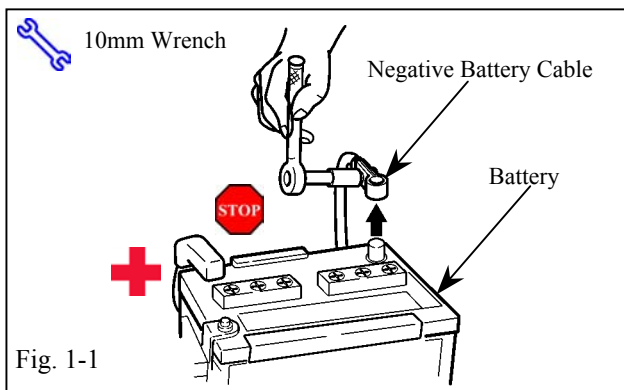

(a) Remove the negative battery cable.
(Fig. 1-1)



- (1) Protect the fender before starting.
- (2) Do not touch the positive terminal with any tool removing the cable.

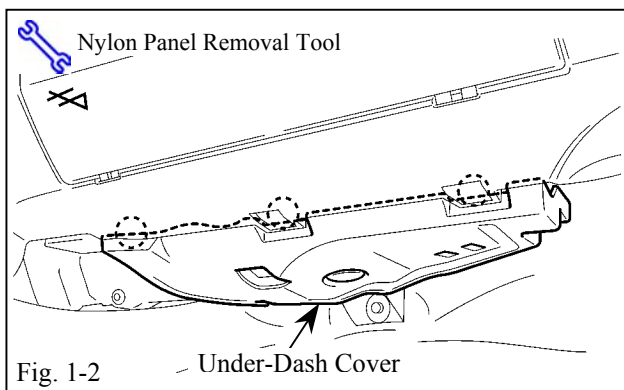

(b) Remove the glove box under-dash cover.
(Fig. 1-2)

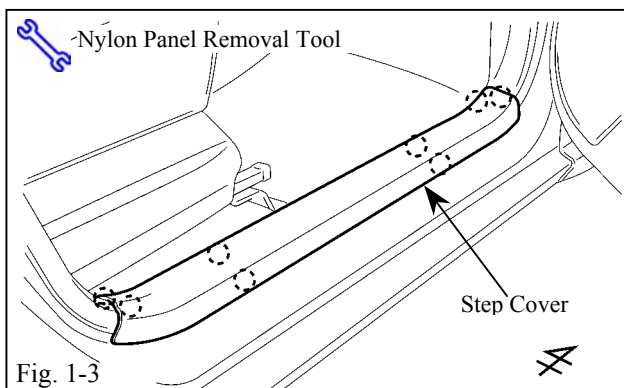

(c) Remove the passenger's step cover.
(Fig. 1-3)

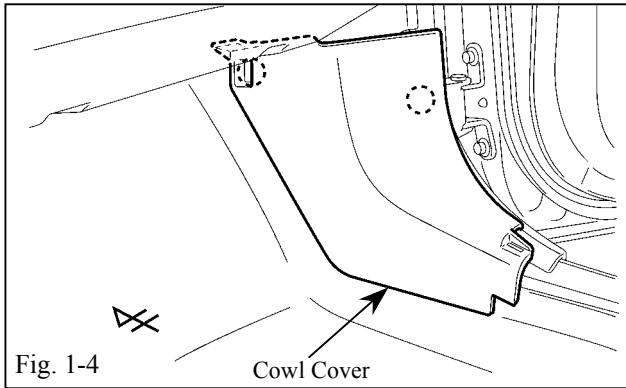

(d) Remove the passenger's cowl cover.
(Fig. 1-4)

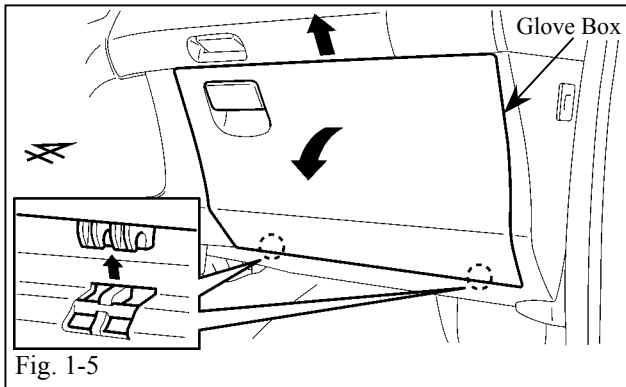

(e) Remove the glove box. (Fig. 1-5)

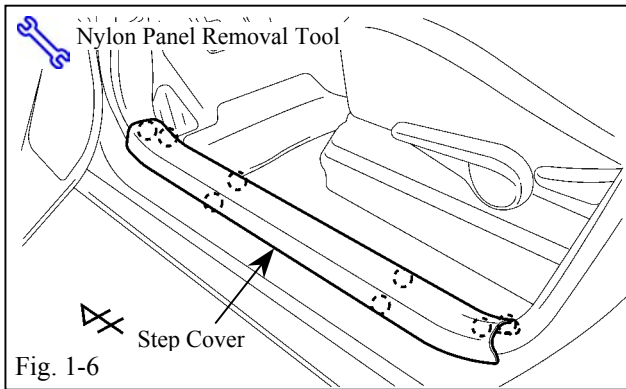

(f) Remove the driver's step cover. (Fig. 1-6)

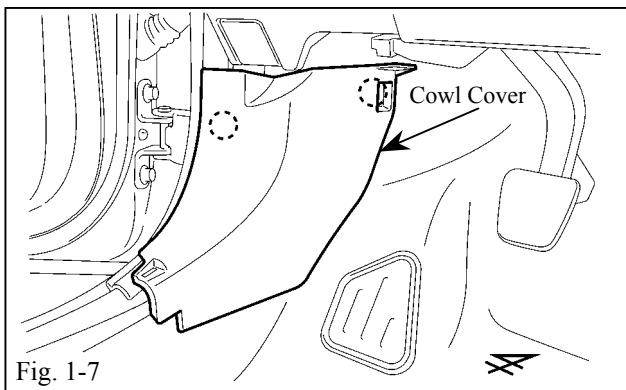

(g) Remove the driver's cowl cover. (Fig. 1-7)

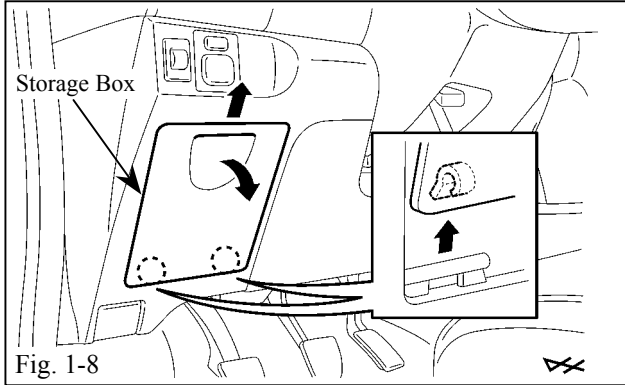

- (h) Remove the storage box from the dashboard. (Fig. 1-8)

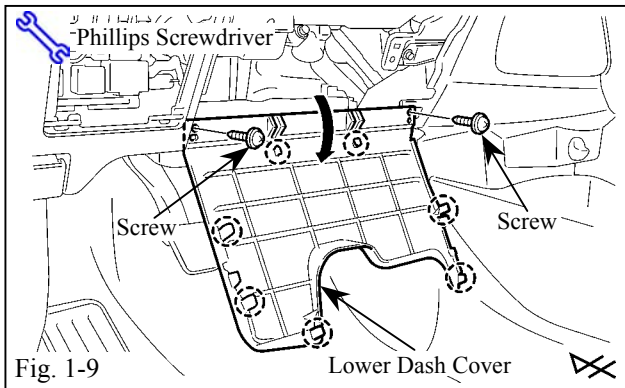

- (i) Remove the lower dash cover from the dashboard. (Fig. 1-9)
 - (1) Remove two screws securing the lower dash cover.

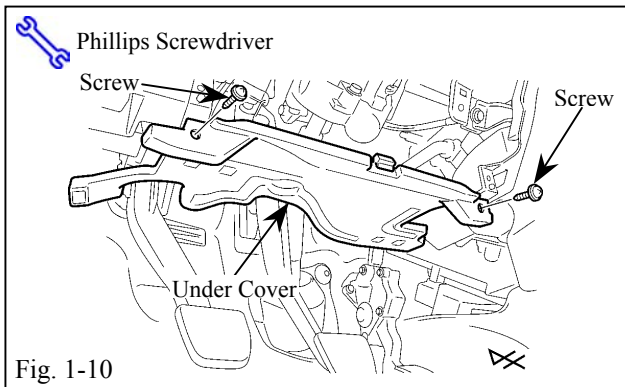

- (j) Remove the driver side under cover. (Fig. 1-10)
 - (1) Remove two screws securing the driver side under cover.

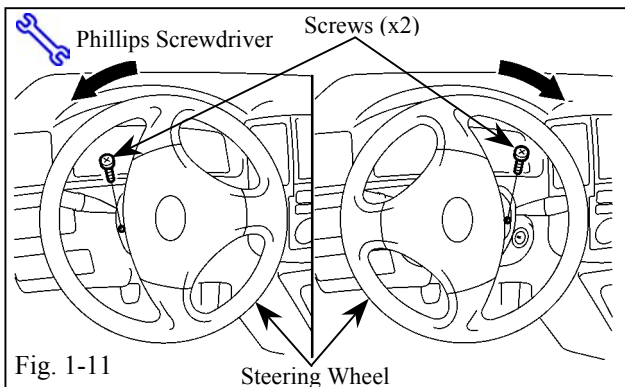

- (k) Remove two screws, located behind the steering wheel, securing the bottom steering column cover. (Fig. 1-11)
 - (1) Insert the key into the ignition switch and turn it to ON, then turn the steering wheel left or right to gain access to the screws

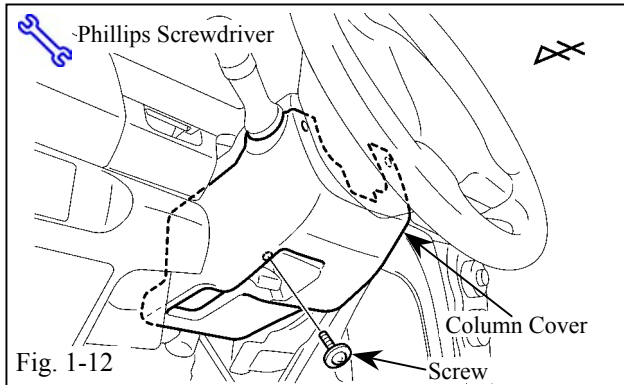

- (l) Remove the lower steering column cover. (Fig. 1-12)
- (1) Remove the bottom screw securing the cover.

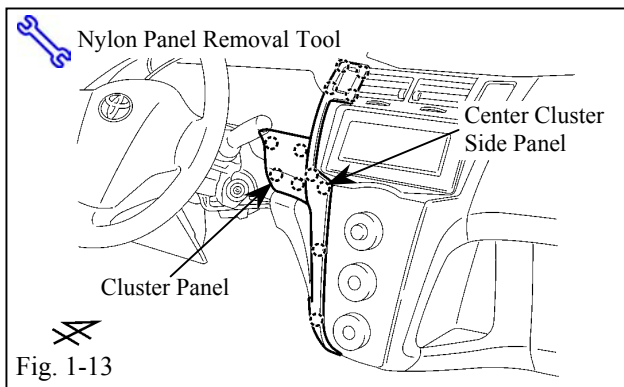

- (m) Remove the left side of the center cluster panel, then remove the cluster panel. (Fig. 1-13)

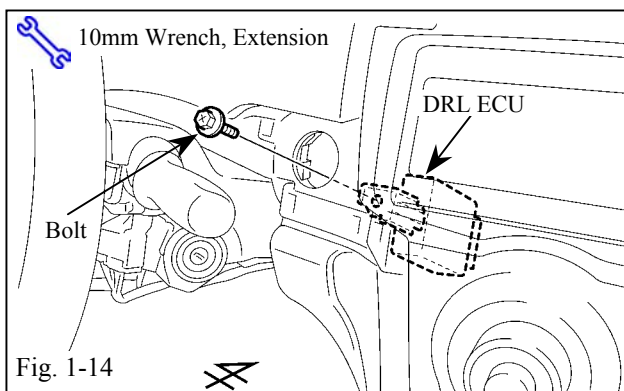

- (n) If equipped, remove the Daytime Running Light (DRL) ECU. (Fig. 1-14)
- (1) Remove one bolt securing the DRL ECU.

FOR MANUAL TRANSMISSION MODELS ONLY. (Steps o-p)

- (o) Remove the shift knob and cluster panel. (Fig. 1-15)
- (p) Loosen the floor console. (Fig. 1-15)
- (1) Remove one bolt securing the floor console.

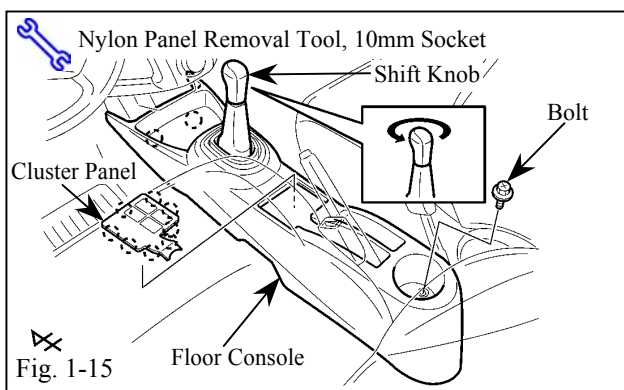

FOR AUTOMATIC TRANSMISSION MODELS ONLY. (Steps q-r)

- (q) Remove the cluster panel. (Fig. 1-15)
- (r) Loosen the floor console. (Fig. 1-15)
- (1) Remove one bolt securing the floor console.

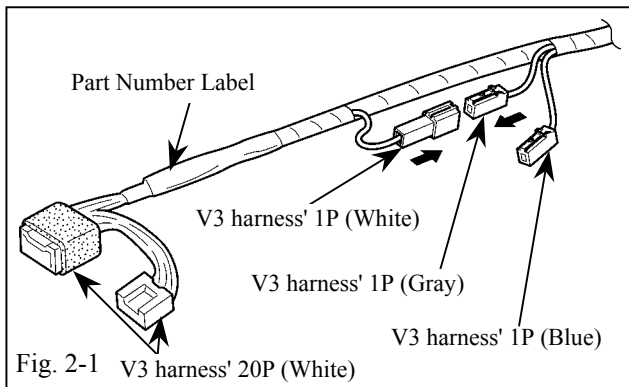

2. V3 Harness Preparation.

- (a) Plug in the V3 harness' white 1P male connector into the V3 harness' gray 1P female connector. (Fig. 2-1)
 - (1) Verify the connectors are plugged in securely.

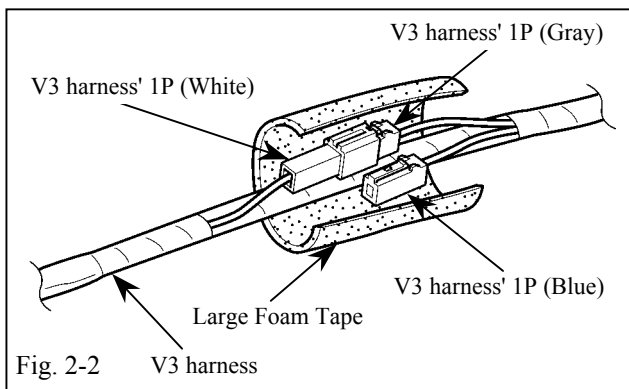

- (b) Secure the connected 1P connectors and the blue 1P connector to the V3 harness with one large foam tape. (Fig. 2-2)

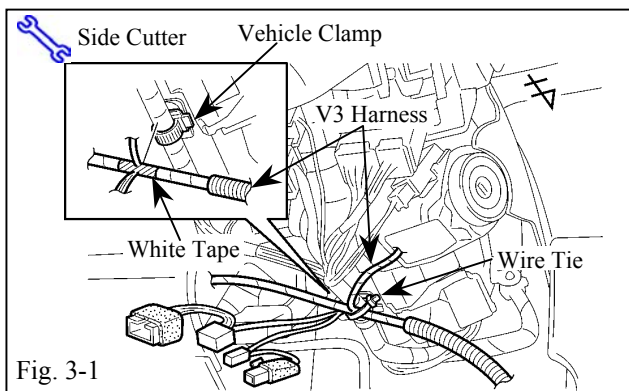

3. V3 Harness Installation. (Steering Column Area)

- (a) Locate the vehicle harness clamp in the steering column area. Secure the V3 harness' white taped marker next to the vehicle harness clamp with one wire tie. (Fig. 3-1)
 - (1) Line up the V3 harness' white taped marker to the vehicle harness clamp.

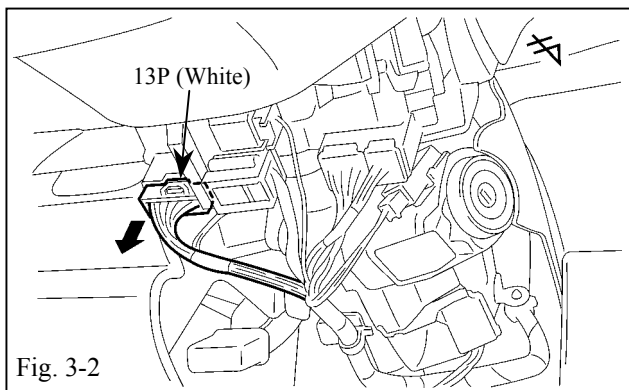

- (b) Locate and disconnect the white 13P connector from the lower part of the steering wheel area. (Fig. 3-2)

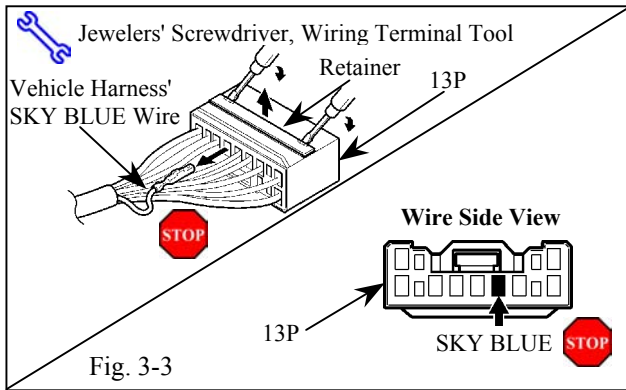

- (c) Using a small jeweler's screwdriver, lift up the terminal retainer on the back of the white 13P connector. (Fig. 3-3)
 - (1) Do not pull out the retainer.
- (d) Locate the SKY BLUE wire in the bottom row, sixth space from the left. Using a pick (or wiring terminal tool [PPO]), release and pull out the terminal for the SKY BLUE wire. (Fig. 3-3)



- (1) Do not damage the terminal.
- (2) Turn the connector so the wire faces you and the tab is on top.

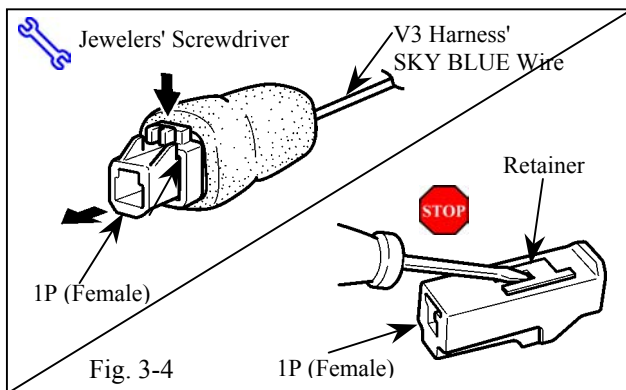

- (e) Disconnect the empty 1P female connector plugged into the V3 harness' SKY BLUE wire. (Fig. 3-4)
 - Using a small jeweler's screwdriver, lift up the terminal retainer on the back of the empty connector. (Fig. 3-4)



- (1) Do not pull out the retainer.

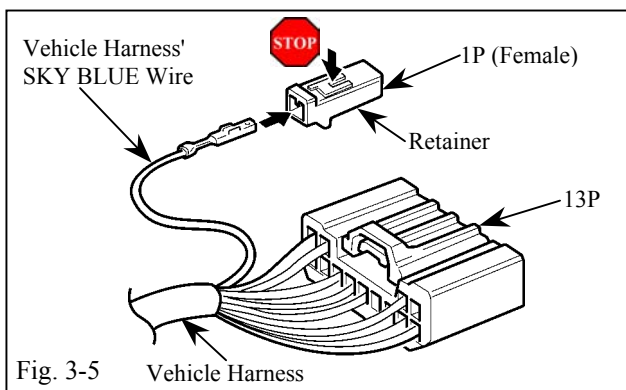

- (f) Insert the terminal at the end of the vehicle harness' SKY BLUE wire into the empty 1P connector. (Fig. 3-5)
 - (1) The terminal should not come out when pulled lightly from the back. If the terminal comes off, then push it in further until securely seated.
- (g) Close the 1P connector's retainer. (Fig. 3-5)



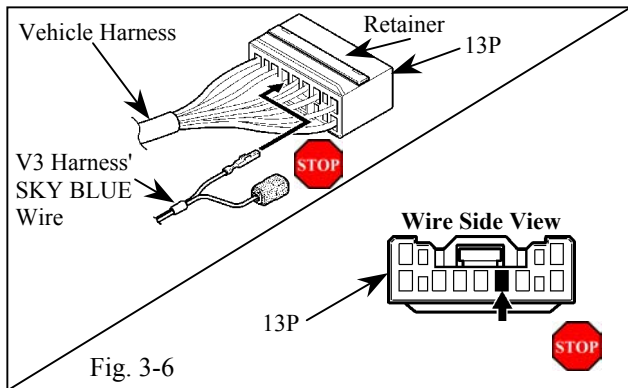

(h) Insert the terminal at the end of the V3 harness' SKY BLUE wire into the bottom row, sixth space from the left of the vehicle harness' 13P connector. (Fig. 3-6)

- (1) Turn the connector so the wire faces you and the tab is on top.
- (2) Verify the correct opening is chosen.
- (3) Verify the terminal is inserted and seated properly.
- (4) The terminal should not come out when pulled lightly from the back. If the terminal comes off, then push it in further until securely seated.

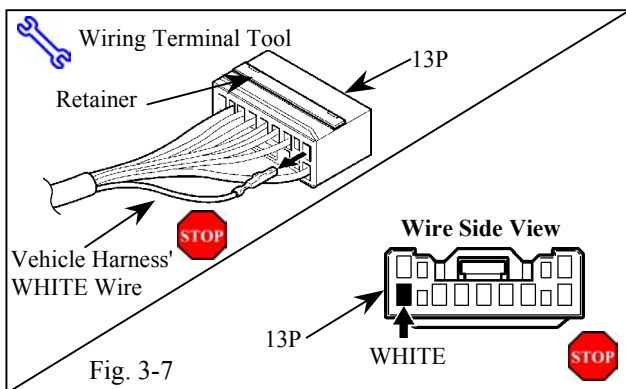

(i) Locate the WHITE wire in the bottom row, first space from the left. Using a pick (or wiring terminal tool [PPO]), release and pull out the terminal for the WHITE wire. (Fig. 3-7)

- (1) Do not damage the terminal.
- (2) Turn the connector so the wire faces you and the tab is on top.

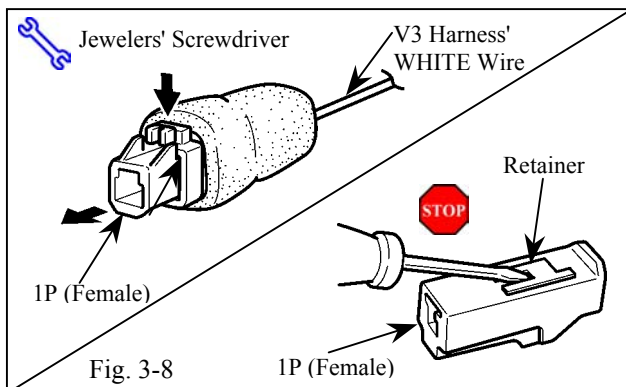

(j) Disconnect the empty 1P female connector plugged into the V3 harness' WHITE wire. (Fig. 3-8) Using a small jeweler's screwdriver, lift up the terminal retainer on the back of the empty connector. (Fig. 3-8)

- (1) Do not pull out the retainer.



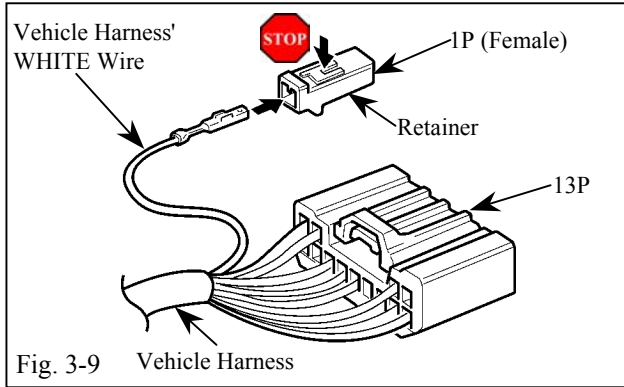

(k) Insert the terminal at the end of the vehicle harness' WHITE wire into the empty 1P connector. (Fig. 3-9)

(l) Close the 1P connector's retainer. (Fig. 3-9)

(1) The terminal should not come out when pulled lightly from the back. If the terminal comes off, then push it in further until securely seated.

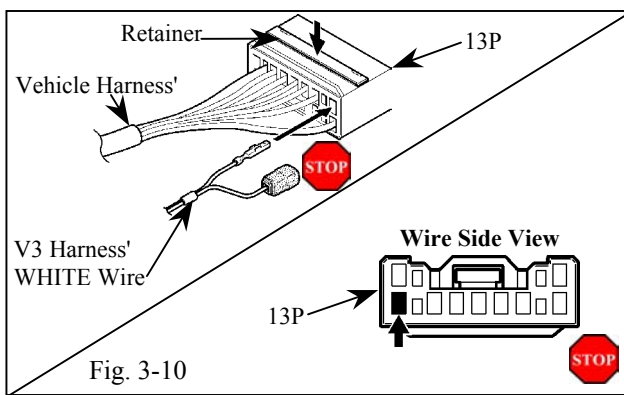

(m) Insert the terminal at the end of the V3 harness' WHITE wire into the bottom, first space from the left of the vehicle harness' 13P connector. (Fig. 3-10)

(1) Turn the connector so the wire faces you and the tab is on top.

(2) Verify the correct opening is chosen.

(3) Verify the terminal is inserted and seated properly.

(4) The terminal should not come out when pulled lightly from the back. If the terminal comes out, push it in further until securely seated.

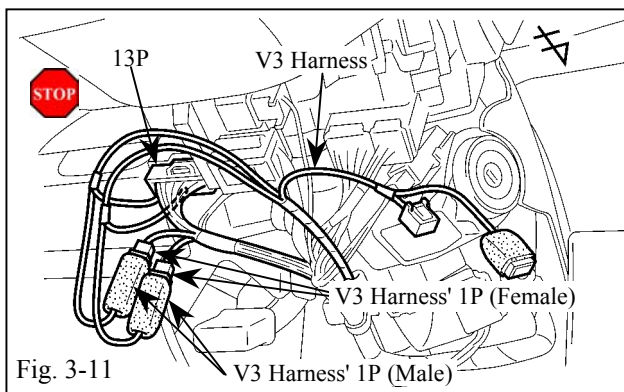

(n) Close the 13P connector's retainer. (Fig. 3-10)

(o) Reconnect the white 13P connector to the steering wheel area. (Fig. 3-11)

(1) Verify the connector is plugged in securely.

(p) Plug in the WHITE wire's connectors (female and male), then plug in the SKY BLUE wire's connectors (female and male). (Fig. 3-11)

(1) Be sure the V3 harness wire's same color is connected.

(2) Verify the connectors are plugged in securely.



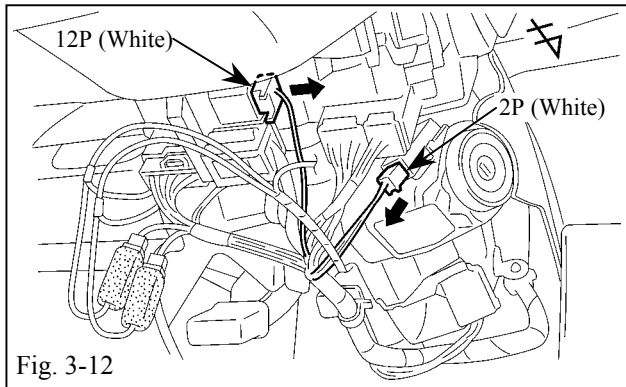

- (q) Locate and disconnect the white 12P and white 2P connector from the lower part of the steering wheel area. (Fig. 3-12)

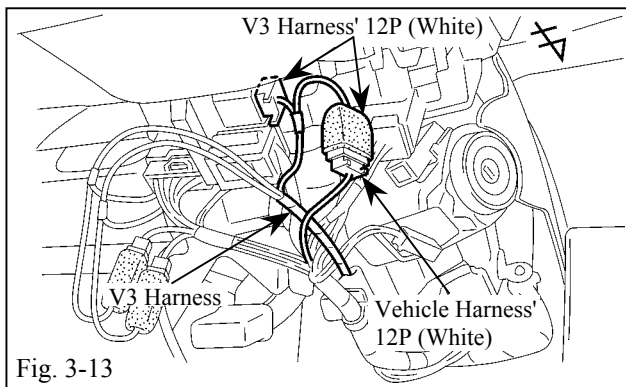

- (r) Plug in the V3 harness' white 12P connectors between the vehicle harness' white 12P connector and the connector block. (Fig. 3-13)
 - (1) Verify the connectors are plugged in securely.

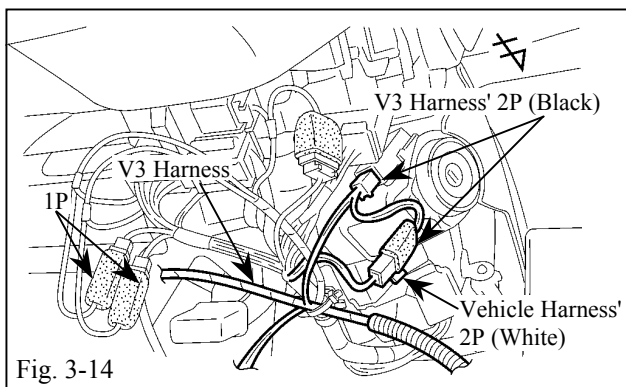

- (s) Plug in the V3 harness' black 2P connectors between the vehicle harness' white 2P connector and the connector block. (Fig. 3-14)
 - (1) Verify the connectors are plugged in securely.

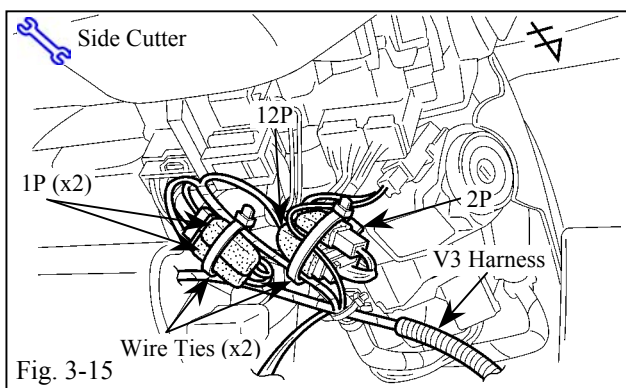

- (t) Secure the 1P connectors to the vehicle harness with one wire tie. (Fig. 3-15)
- (u) Secure the 2P and 12P connectors to the vehicle harness with one wire tie. (Fig. 3-15)

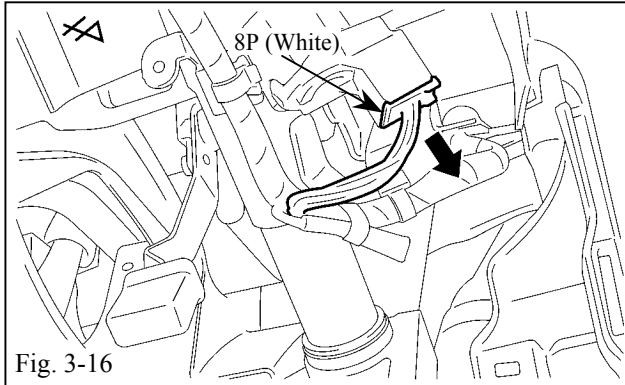

- (v) Locate and disconnect the white 8P connector from the ignition switch. (Fig. 3-16)

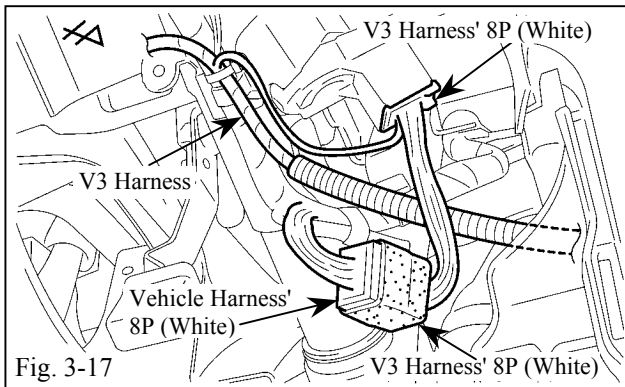

- (w) Plug in the V3 harness' white 8P connectors between the vehicle harness' white 8P connector and the ignition switch. (Fig. 3-17)
- (1) Verify the connectors are plugged in securely.

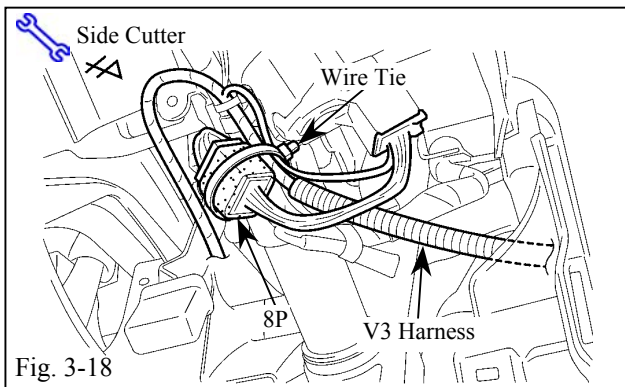

- (x) Secure the 8P connectors to the vehicle harness with one wire tie. (Fig. 3-18)

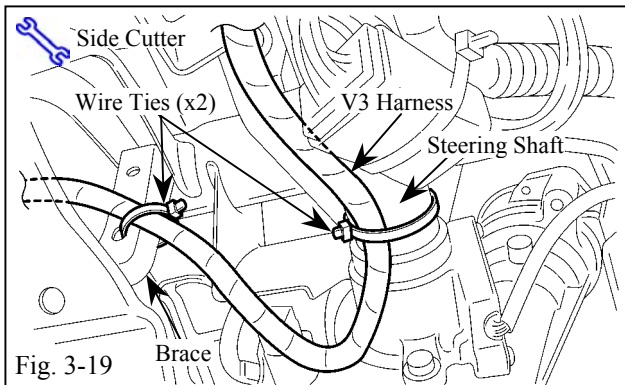

- (y) Route and secure the V3 harness to the steering shaft with one wire tie. (Fig. 3-19)
- (z) Route the V3 harness toward the instrument panel J/B area, then secure it to the driver side brace with one wire tie. (Fig. 3-19)
- (1) Insert a wire tie through the hole in the brace, then secure the V3 harness with the wire tie.

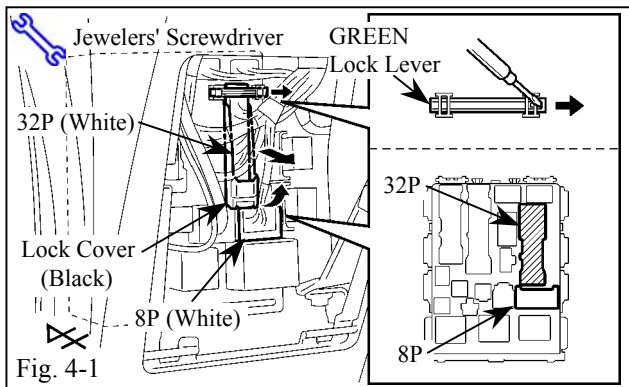

4. V3 Harness Installation.
(Driver's Instrument Panel J/B Area)

- (a) Using a jeweler's screwdriver, release and remove the green lock lever. (Fig. 4-1)
 Disconnect the white 8P connector, then release the white 32P connector's lock from the instrument panel J/B. (Fig. 4-1)
- (b) Disconnect the white 32P connector. (Fig. 4-1)

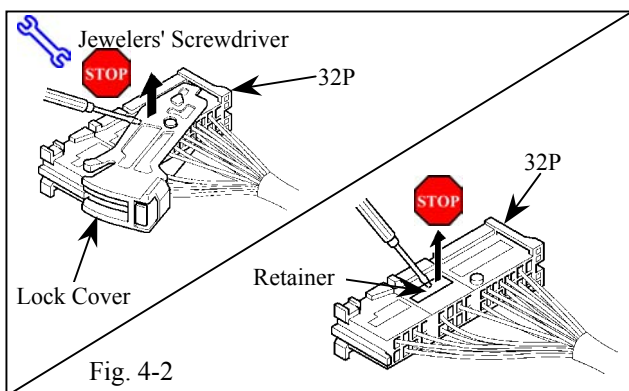

- (c) Using a small screwdriver, lift up and slide the 32P connector's black lock cover. (Fig. 4-2)
 (1) Do not damage the lock cover.
- (d) Using a small jeweler's screwdriver, lift up the terminal retainer on the 32P connector. (Fig. 4-2)
 (1) Do not pull out the retainer.

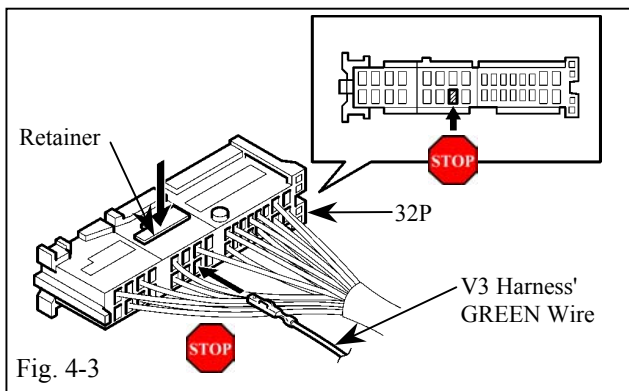

- (e) Insert the terminal at the end of the V3 harness' GREEN wire into the bottom row, seventh space from the left of the vehicle harness' 32P connector. (Fig. 4-3)
 (1) Verify the correct opening is chosen.
 (2) Verify the terminal is inserted and seated properly.
 (3) The terminal should not come out when pulled lightly from the back. If the terminal comes out, push it in further until securely seated.

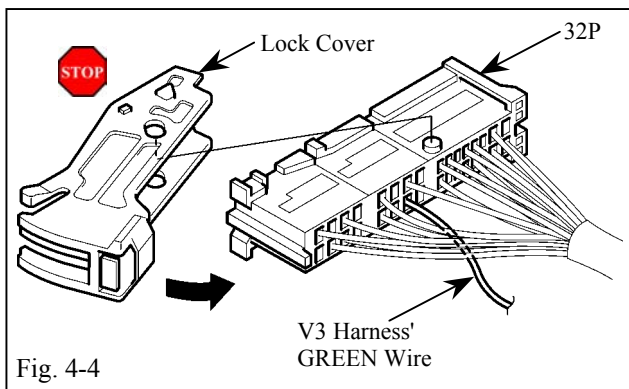

- (f) Close the retainer. (Fig. 4-3)
- (g) Refit the 32P connector's black lock cover. (Fig. 4-4)
 (1) Do not damage the lock cover.

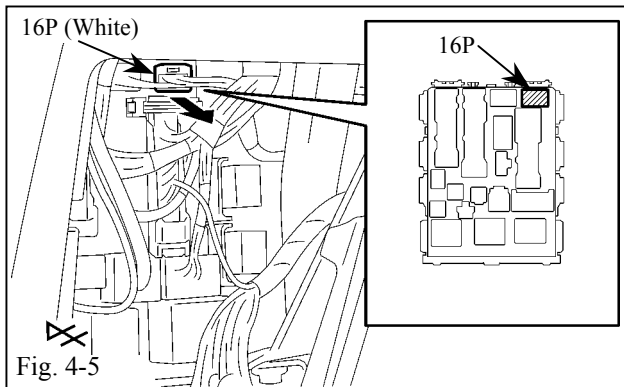

- (h) Locate and disconnect the white 16P connector from the instrument panel J/B. (Fig. 4-5)

FOR VEHICLES WITHOUT IMMOBILIZER SYSTEM ONLY. (Steps i-j)

- (i) Using a small jeweler's screwdriver, lift up the terminal retainer on the back of the white 16P connector. (Fig. 4-6)
- (j) Insert the terminal at the end of the V3 harness' BLACK wire into the top row, third space from the left of the vehicle harness' 16P connector. (Fig. 4-6)
- (1) Turn the connector so the wire faces you and the tab is on top.
 - (2) Verify the correct opening is chosen.
 - (3) Verify the terminal is inserted and seated properly.
 - (4) The terminal should not come out when pulled lightly from the back. If the terminal comes off, then push it in further until securely seated.

Go to Section 4 on Step (q).

FOR VEHICLES WITH IMMOBILIZER SYSTEM ONLY. (Steps k-m)

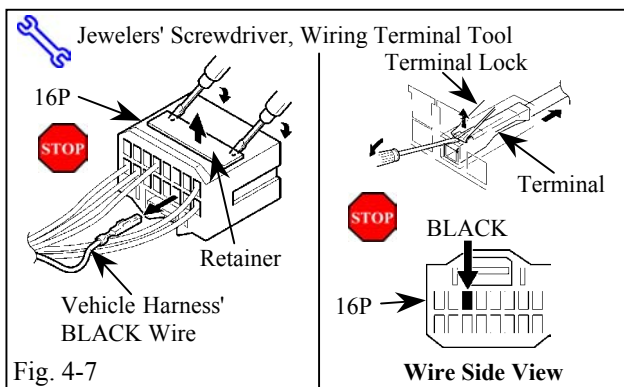
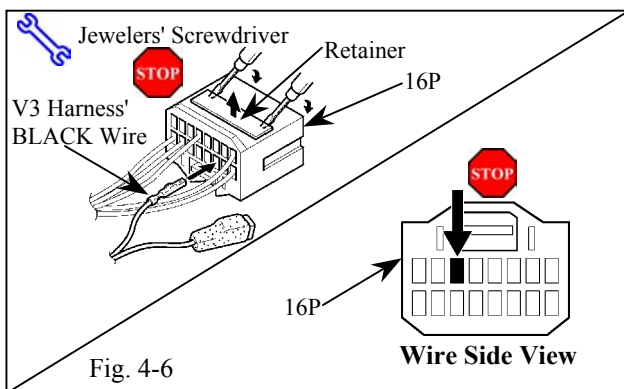

- (k) Using a small jeweler's screwdriver, lift up the terminal retainer on the back of the white 16P connector. (Fig. 4-7)
- (1) Before pulling out the terminal, be sure to release the terminal lock. If the terminal is forcibly pulled out without being unlocked, the terminal lock will be broken and cannot be reused.
 - (2) Do not pull out the retainer.

- (l) Locate the BLACK wire in the top row, third space from the left. Using a pick (or wiring terminal tool [PPO]), release and pull out the terminal for the BLACK wire. (Fig. 4-7)
- (1) Do not damage the terminal.
 - (2) Turn the connector so the wire faces you and the tab is on top.

- (m) Disconnect the empty 2P female connector plugged into the V3 harness' BLACK wire. (Fig. 4-8)

Using a small jeweler's screwdriver, lift up the terminal retainer on the back of the empty connector. (Fig. 4-8)

- (1) Do not pull out the retainer.

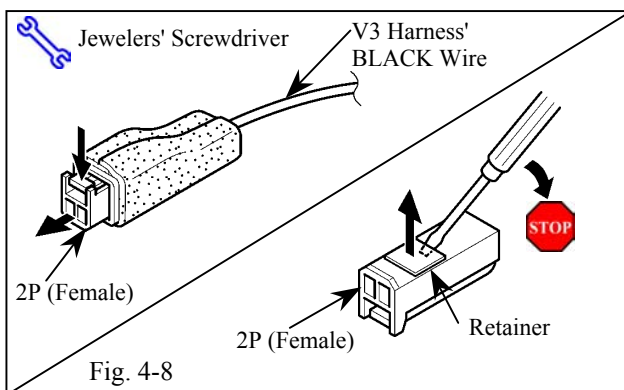

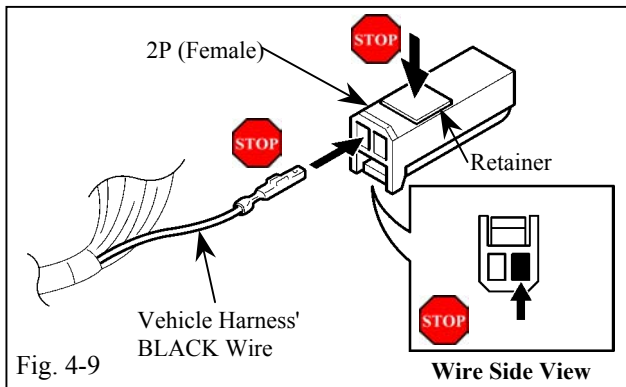

Fig. 4-9

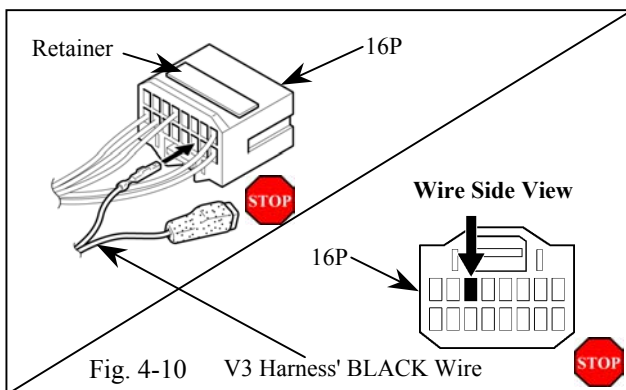

Fig. 4-10 V3 Harness' BLACK Wire

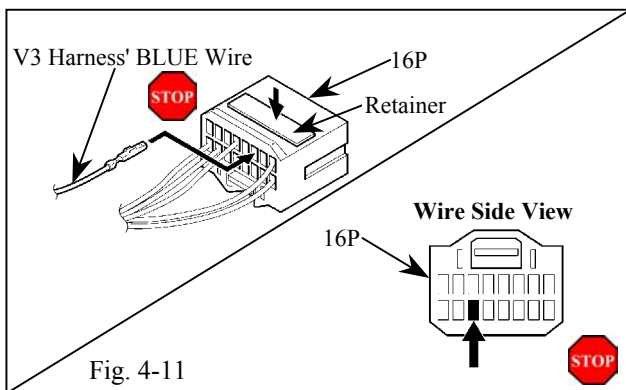
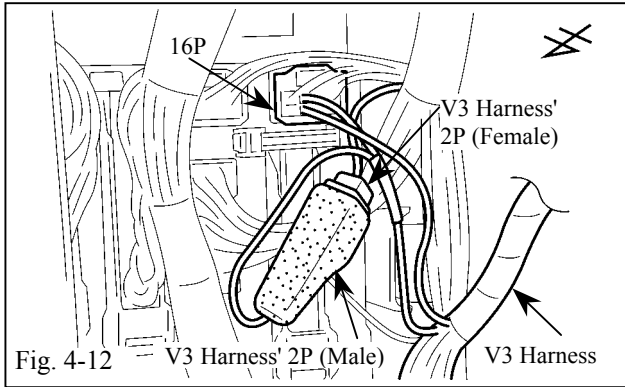

Fig. 4-11

FOR VEHICLES WITH IMMOBILIZER SYSTEM ONLY. (Steps n-p)

- (n) Insert the terminal at the end of the vehicle harness' BLACK wire into the right side opening of the empty 2P connector. (Fig. 4-9)
 - (1) Turn the connector so the wire faces you and the tab is on top.
 - (2) Verify the correct opening is chosen.
 - (3) Verify the terminal is inserted and seated properly.
 - (4) The terminal should not come out when pulled lightly from the back. If the terminal comes out, push it in further until securely seated.
- (o) Close the 2P connector's retainer. (Fig. 4-9)
- (p) Insert the terminal at the end of the V3 harness' BLACK wire into the top row, third space from the left of the vehicle harness' 16P connector. (Fig. 4-10)
 - (1) Turn the connector so the wire faces you and the tab is on top.
 - (2) Verify the correct opening is chosen.
 - (3) Verify the terminal is inserted and seated properly.
 - (4) The terminal should not come out when pulled lightly from the back. If the terminal comes out, push it in further until securely seated.
- (q) Insert the terminal at the end of the V3 harness' BLUE wire into the bottom row, third space from the left of the vehicle harness' 16P connector. (Fig. 4-11)
 - (1) Turn the connector so the wire faces you and the tab is on top.
 - (2) Verify the correct opening is chosen.
 - (3) Verify the terminal is inserted and seated properly.
 - (4) The terminal should not come out when pulled lightly from the back. If the terminal comes out, push it in further until securely seated.
- (r) Close the 16P connector's retainer. (Fig. 4-11)





- (s) Plug the V3 harness' white 2P male connector into the V3 harness' white 2P female connector, then reconnect the white 16P connector to the instrument panel J/B. (Fig. 4-12)

(1) Verify the connectors are plugged in securely.

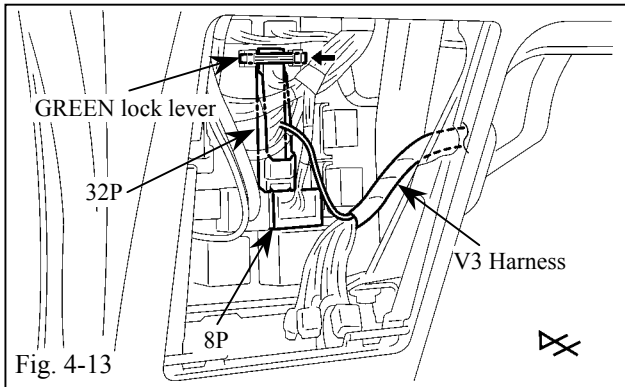

- (t) Reconnect the white 32P connector to the instrument panel J/B, then refit the green lock lever. (Fig. 4-13)

Reconnect the white 8P connector. (Fig. 4-13)

(1) Verify the connector is plugged in securely.

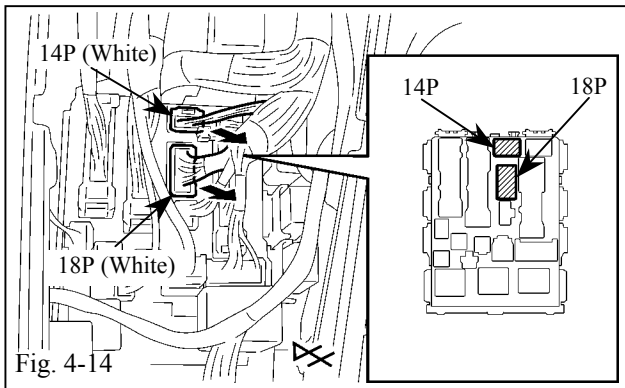

- (u) Locate and disconnect the white 14P and white 18P connector from the instrument panel J/B. (Fig. 4-14)

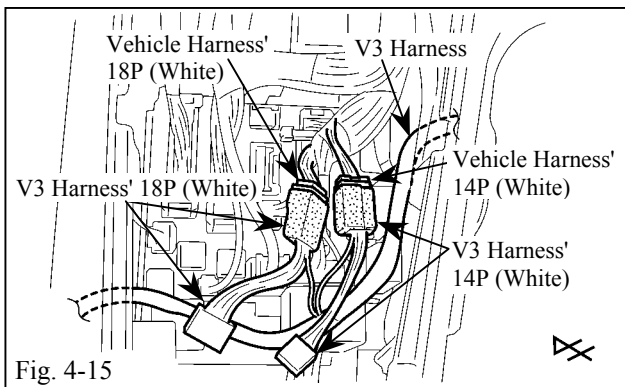

- (v) Connect the V3 harness' white 14P connector to the vehicle harness' white 14P connector. (Fig. 4-15)

Connect the V3 harness' white 18P connector to the vehicle harness' white 18P connector. (Fig. 4-15)

(1) Verify the connectors are plugged in securely.

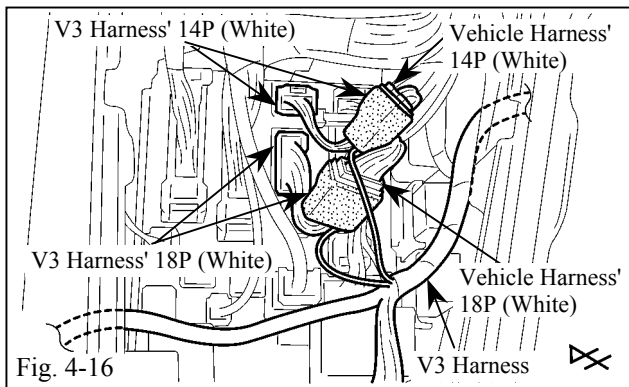

- (w) Connect the V3 harness' white 14P connector to the instrument panel J/B. (Fig. 4-16)
- Connect the V3 harness' white 18P connector to the instrument panel J/B. (Fig. 4-16)
- (1) Verify the connectors are plugged in securely.

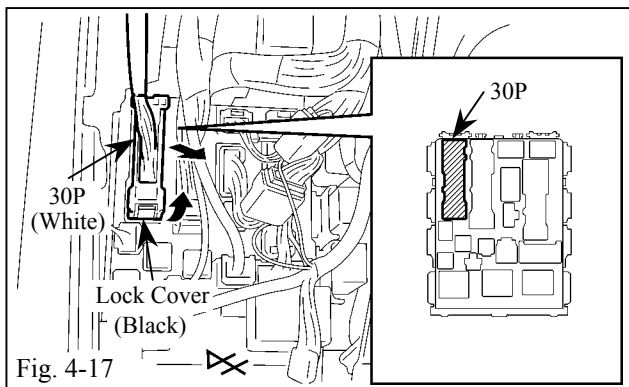

- (x) Locate and disconnect the white 30P connector's lock from the instrument panel J/B. (Fig. 4-17)
- (y) Disconnect the white 30P connector. (Fig. 4-17)

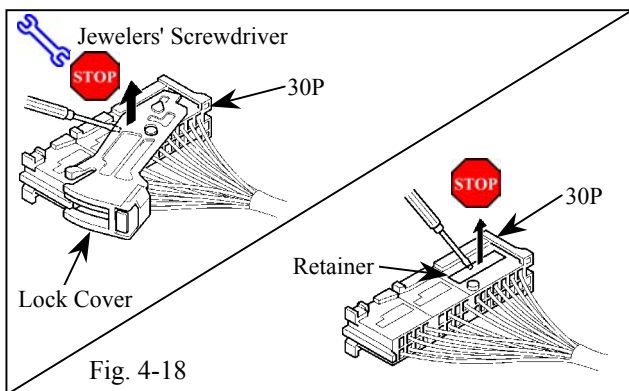

- (z) Using a small screwdriver, lift up and slide the black lock cover from the 30P connector. (Fig. 4-18)
- (1) Do not damage the lock cover.
- (aa) Using a small jeweler's screwdriver, lift up the terminal retainer on the 30P connector. (Fig. 4-18)
- (1) Do not pull out the retainer.

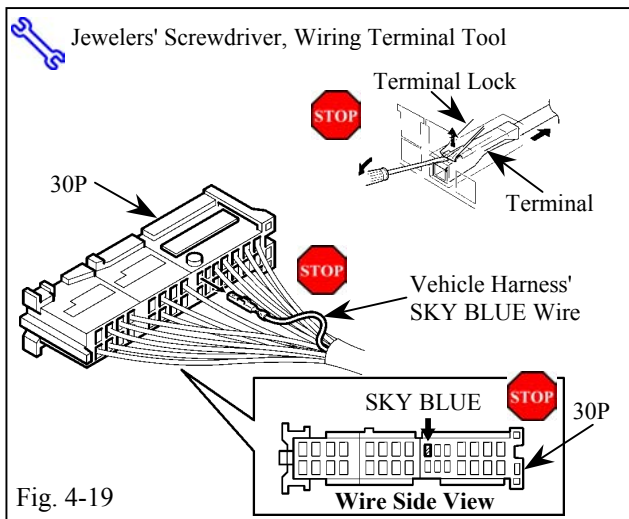

- (bb) Locate the SKY BLUE wire in the top row, ninth space from the left. (Fig. 4-19)
- Using a pick (or wiring terminal tool [PPO]), release and pull out the terminal for the SKY BLUE wire. (Fig. 4-19)
- (1) Before pulling out the terminal, be sure to release the terminal lock. If the terminal is forcibly pulled out without being unlocked, the terminal lock will be broken and cannot be reused.
- (2) Do not damage the terminal.

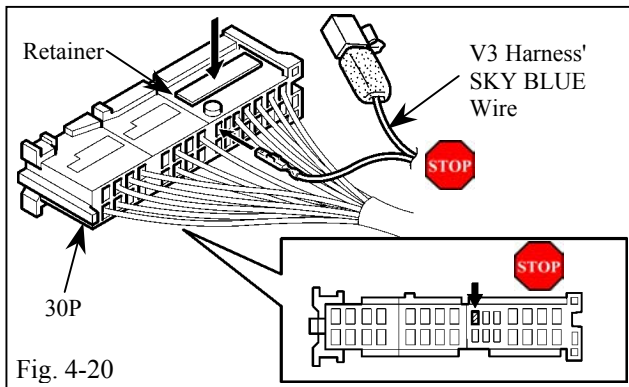

Fig. 4-20

(cc) Insert the terminal on the end of the V3 harness' SKY BLUE wire into the top row, ninth space from the left of the vehicle harness' 30P connector. (Fig. 4-20)

- (1) Verify the correct opening is chosen.
- (2) Verify the terminal is inserted and seated properly.
- (3) The terminal should not come out when pulled lightly from the back. If the terminal comes out, push it in further until securely seated.

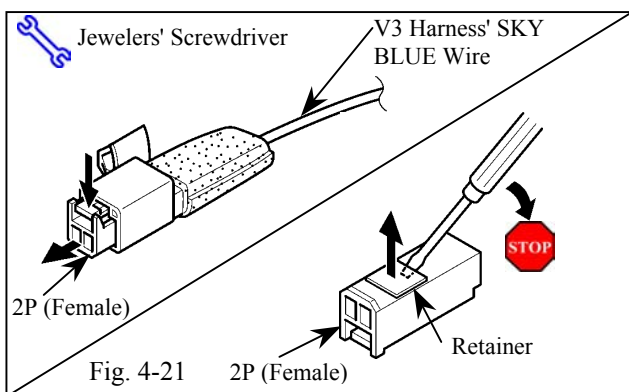

Fig. 4-21

(dd) Close the retainer. (Fig. 4-20)

(ee) Disconnect the empty 2P female connector plugged into the V3 harness' SKY BLUE wire. (Fig. 4-21)

Using a small jeweler's screwdriver, lift up the terminal retainer on the back of the empty connector. (Fig. 4-21)

(1) Do not pull out the retainer.

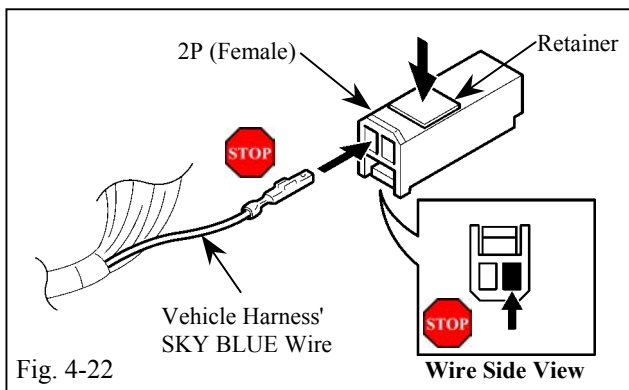

Fig. 4-22

(ff) Insert the terminal at the end of the vehicle harness' SKY BLUE wire into the right side opening of the empty 2P connector. (Fig. 4-22)

- (1) Turn the connector so the wire faces you and the tab is on top.
- (2) Verify the correct opening is chosen.
- (3) Verify the terminal is inserted and seated properly.

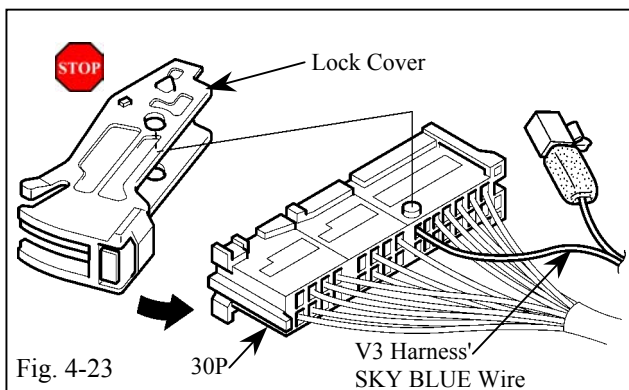

Fig. 4-23

(4) The terminal should not come out when pulled lightly from the back. If the terminal comes out, push it in further until securely seated.

(gg) Close the 2P connector's retainer. (Fig. 4-22)

(hh) Refit the 30P connector's black lock cover. (Fig. 4-23)

(1) Do not damage the lock cover.



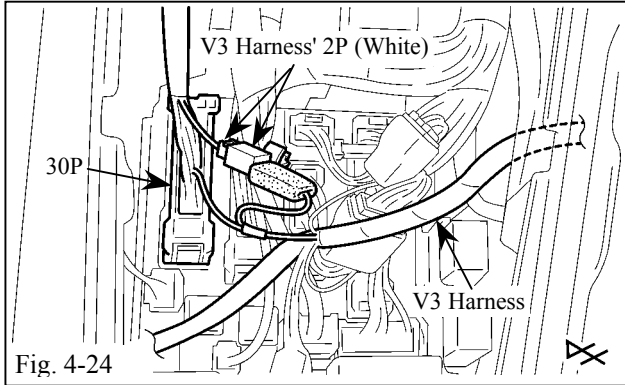

- (ii) Plug in the V3 harness' white 2P male connector into the V3 harness' white 2P female connector, then reconnect the white 30P connector to the instrument panel J/B. (Fig. 4-24)

(1) Verify the connectors are plugged in securely.

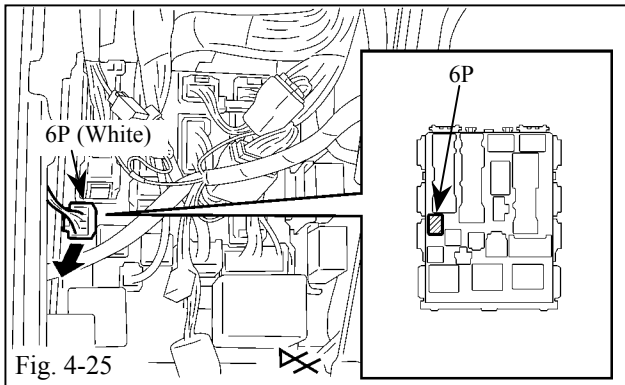

- (jj) Locate and disconnect the white 6P connector from the instrument panel J/B. (Fig. 4-25)

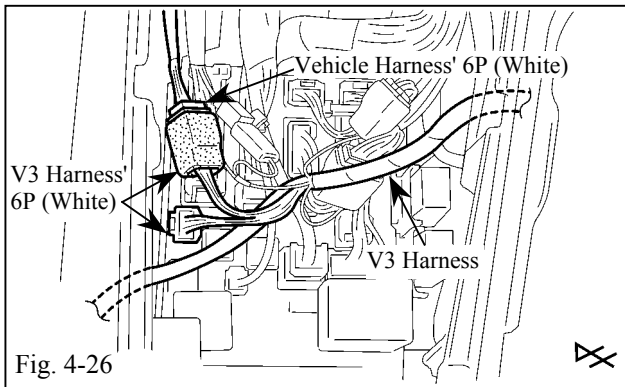

- (kk) Plug the V3 harness' white 6P connectors between the vehicle harness' white 6P connector and the instrument panel J/B. (Fig. 4-26)

(1) Verify the connectors are plugged in securely.

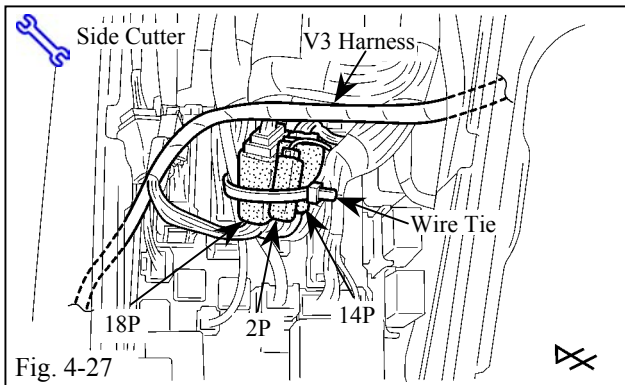

- (ll) Secure the 2P, 14P, and 18P connectors to the vehicle harness with one wire tie. (Fig. 4-27)

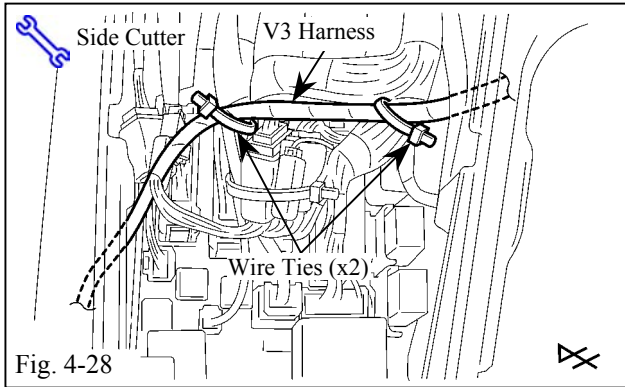

(mm) Secure the V3 harness to the vehicle harness with two wire ties. (Fig. 4-28)

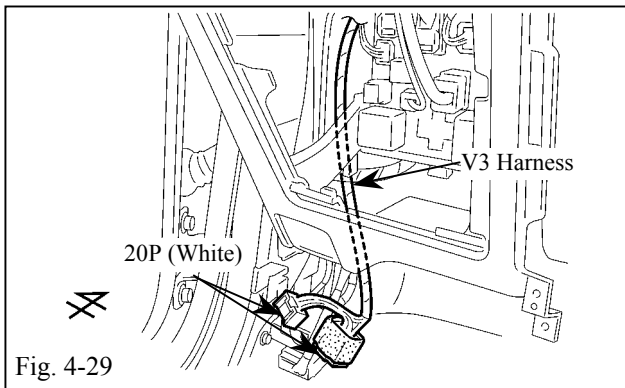

(nn) Route the V3 harness' white 20P connectors toward the driver's cowl area. (Fig. 4-29)

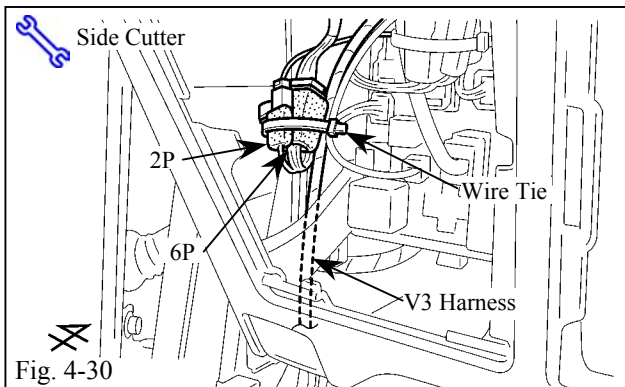

(oo) Secure the 2P and 6P connectors to the vehicle harness with one wire tie. (Fig. 4-30)

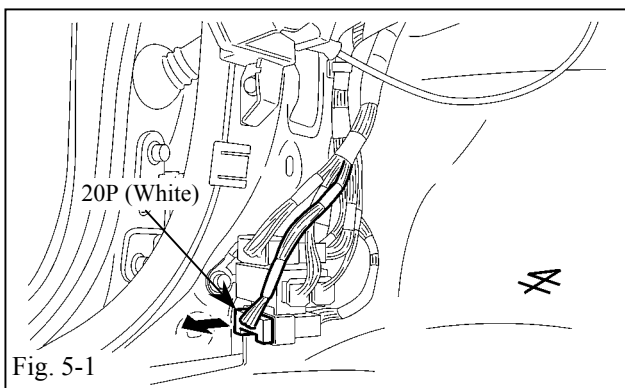

5. V3 Harness Installation. (Driver's Cowl Area)

(a) Locate and disconnect the white 20P connector from the driver's cowl area. (Fig. 5-1)

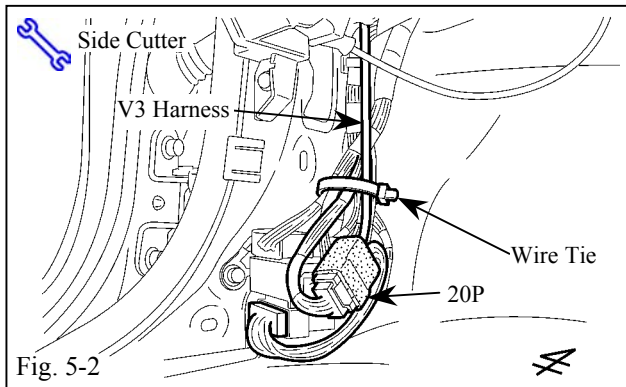

(b) Plug in the V3 harness' white 20P connectors between the vehicle harness' white 20P connector and the connector block. (Fig. 5-2)

(1) Verify the connectors are plugged in securely.

(c) Secure the V3 harness to the vehicle harness with one wire tie. (Fig. 5-2)

6. V3 Harness Installation.

(From Steering Column Area to Glove Box Area)

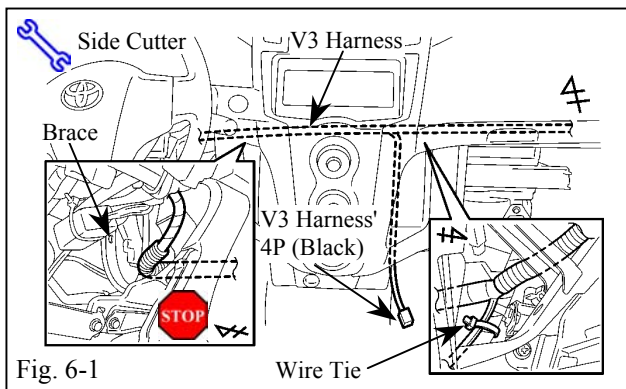

(a) Route the V3 harness toward the floor console area and glove box area, then secure it to the vehicle harness in the glove box area with one wire tie. (Fig. 6-1)

(1) Be sure to route the V3 harness to the upper part of the brace as shown.

(2) Route the V3 harness away from any moving parts such as levers, etc.

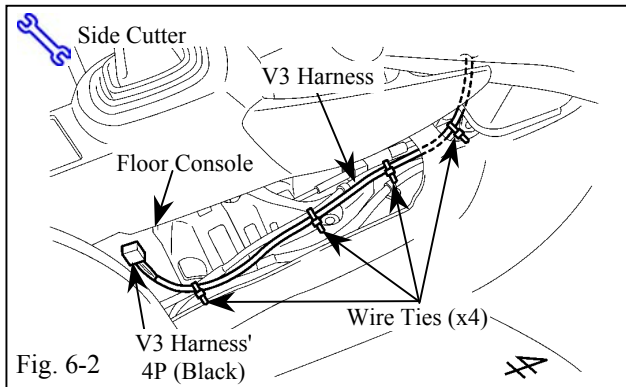

(b) Route the V3 harness' black 4P connector toward the floor console area, then secure it to the vehicle harness with four wire ties. (Fig. 6-2)

7. Status Monitor Installation.

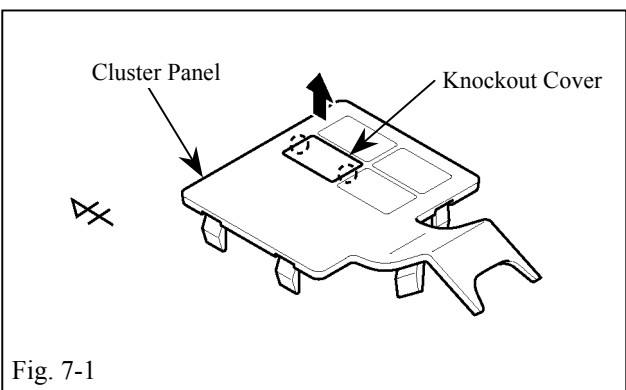

(a) Remove the knockout cover from the cluster panel as shown. (Fig. 7-1)

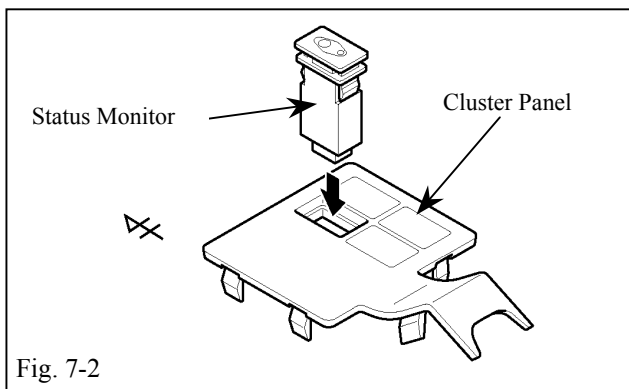

(b) Insert the status monitor into the knockout opening of the cluster panel. (Fig. 7-2)

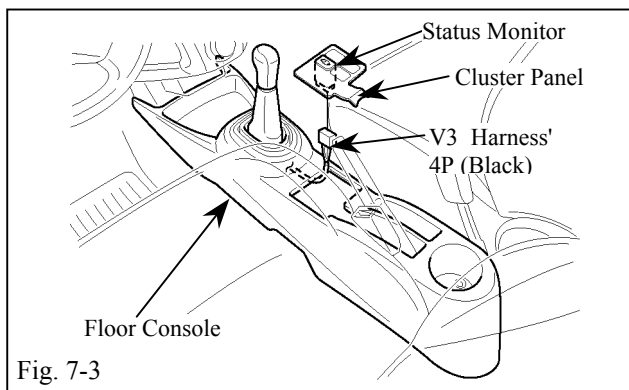

(c) Plug the V3 harness' black 4P connector into the status monitor. (Fig. 7-3)

(1) Verify the connectors are plugged in securely.

8. V3 ECU Preparation and Installation.

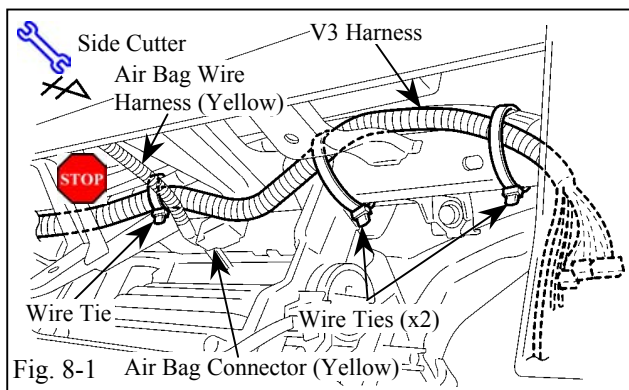

(a) Route the V3 harness toward the glove box area, then secure it to the vehicle harness with three wire ties. (Fig. 8-1)

(1) Be sure to route the V3 harness upper part of the air bag wire harness as shown.
 (2) Do not secure the air bag yellow wires.

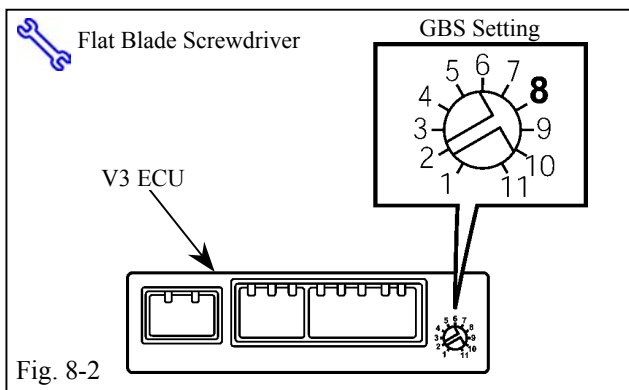

(b) Turn the adjustment screw on the V3 ECU to the "8" position. (Fig. 8-2)

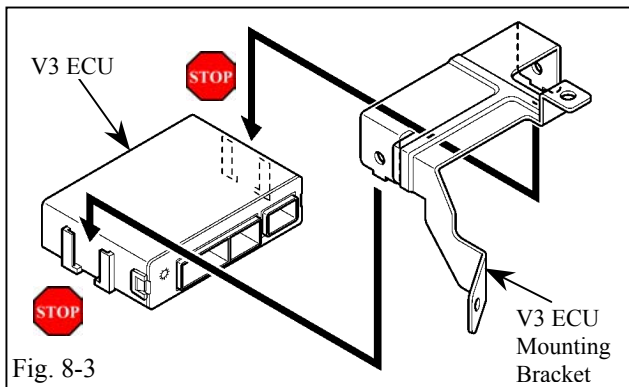

Fig. 8-3

- (c) Insert the V3 ECU mounting bracket into the indicated bracket slot on the V3 ECU. (Fig. 8-3)

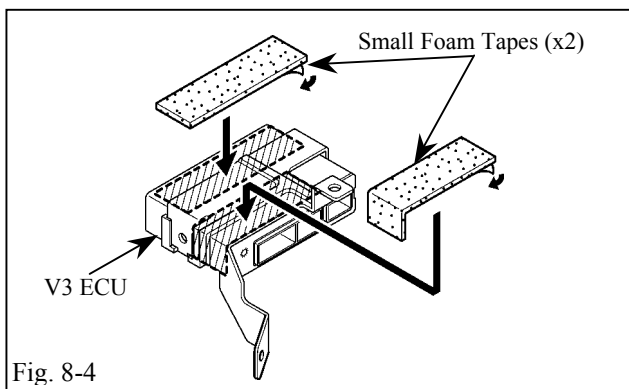

Fig. 8-4

- (1) Insert the mounting bracket into the correct slot; you have only one chance to install it properly.

- (d) Apply two small foam tapes to the V3 ECU as shown. (Fig. 8-4)

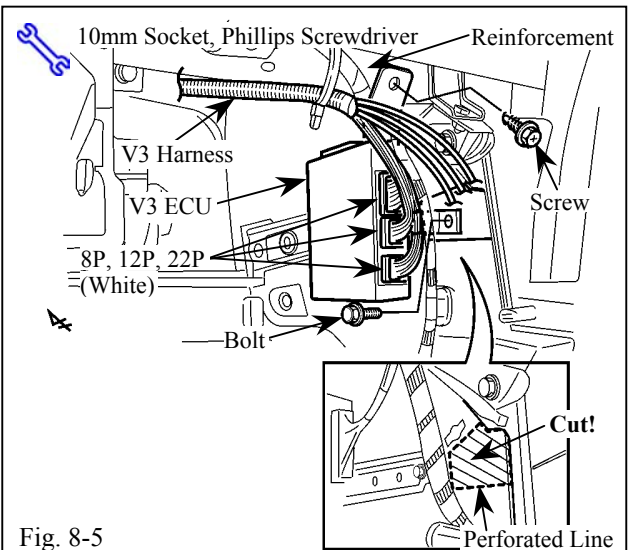

Fig. 8-5

- (e) Locate the perforated line in the right side of the glove box area, then cut off the carpet. (Fig. 8-5)

- (f) Connect the V3 harness' white 8P, white 12P, and white 22P connectors to the V3 ECU. (Fig. 8-5)

- (g) Temporarily install the V3 ECU bracket to the vehicle's body in the glove box area with one bolt supplied in the kit. (Fig. 8-5)

- (1) Do not tighten the bolt yet.

- (h) Using the screw supplied in the kit, secure the upper portion of the V3 ECU bracket to the reinforcement, then tighten the bolt. (Fig. 8-5)

- (1) Verify the screw and bolt are tightened and secured.

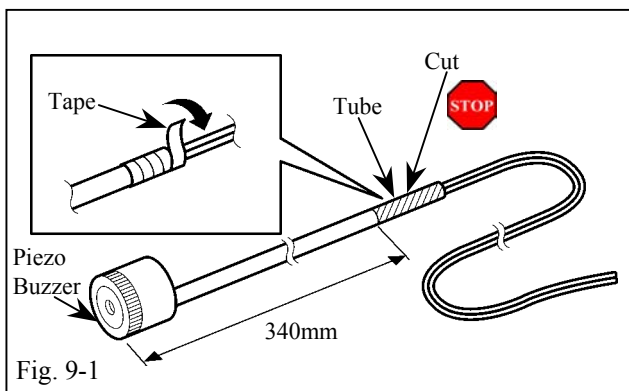
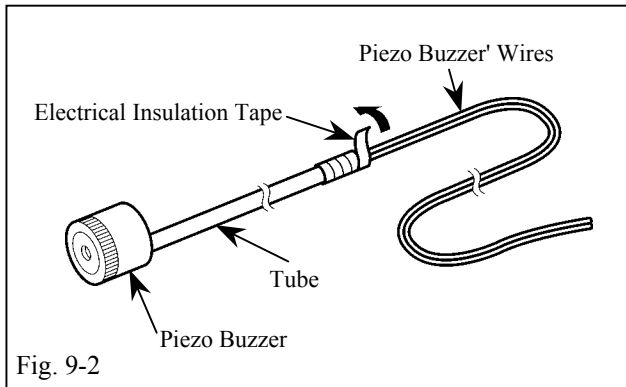

Fig. 9-1

9. Piezo Buzzer Installation.

- (a) Remove the tape from the Piezo Buzzer harness. (Fig. 9-1)
- (b) Cut off the Piezo Buzzer's tube as shown. (Fig. 9-1)

- (1) Do not cut the wires.
- (2) Discard the cut tube.



(c) Wrap the Piezo Buzzer's wires and the tube with electrical insulation tape. (Fig. 9-2)

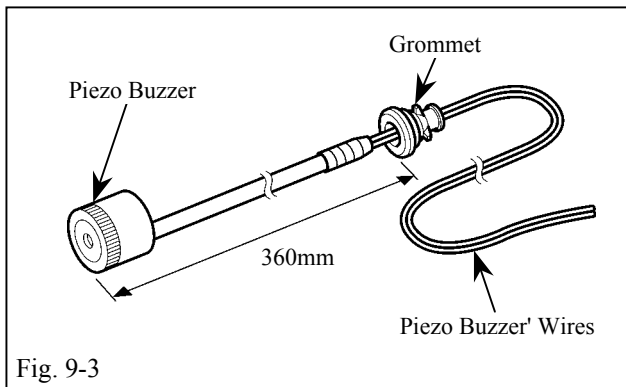

(d) Slide the grommet over the wires of the Piezo Buzzer as shown. (Fig. 9-3)

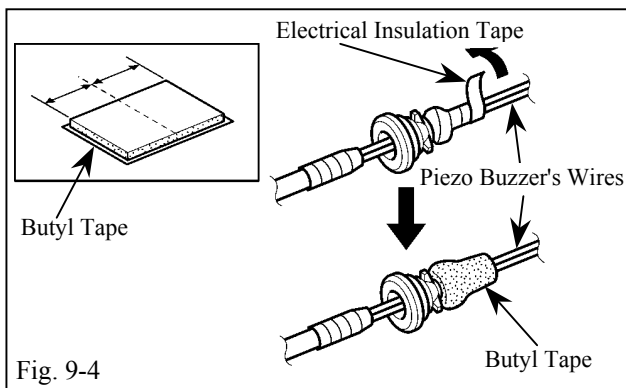

(e) Wrap the Piezo Buzzer's wires and grommet with electrical insulation tape. (Fig. 9-4)

(f) Cut the butyl tape in half, then wrap it around the electrical insulation tape. (Fig. 9-4)

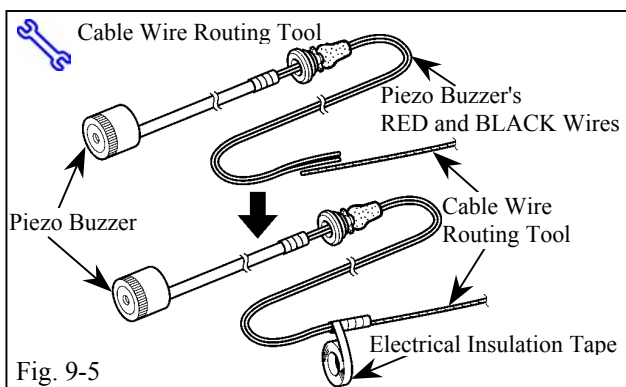

(g) Secure the Piezo Buzzer's wires and the cable wire routing tool (PPO only) or the like with electrical insulation tape. (Fig. 9-5)

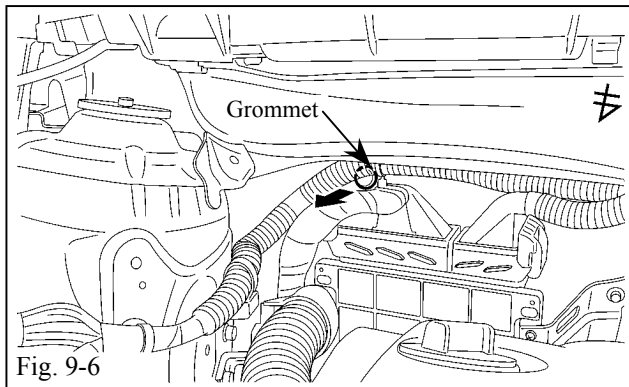

- (h) Remove the grommet from the passenger side of the engine compartment wall. (Fig. 9-6)

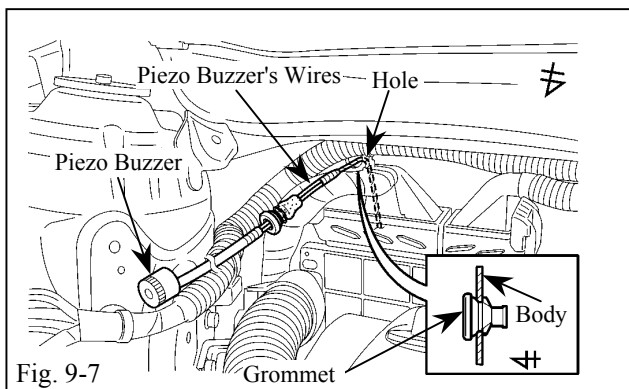

- (i) Push the entire length of the cable wire routing tool and Piezo Buzzer's wires through the engine compartment wall's hole and into the passenger compartment. (Fig. 9-7)

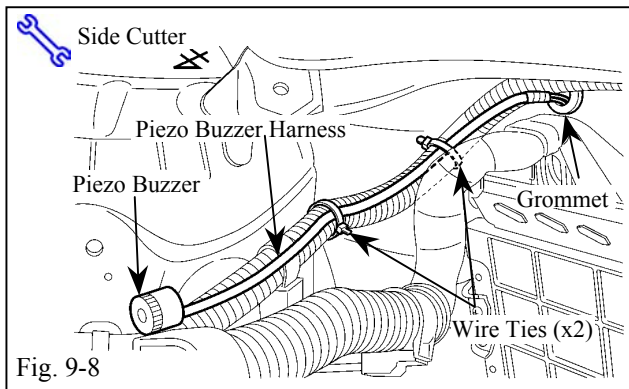

- (j) Route and secure the Piezo Buzzer harness to the vehicle harness with two wire ties. (Fig. 9-8)

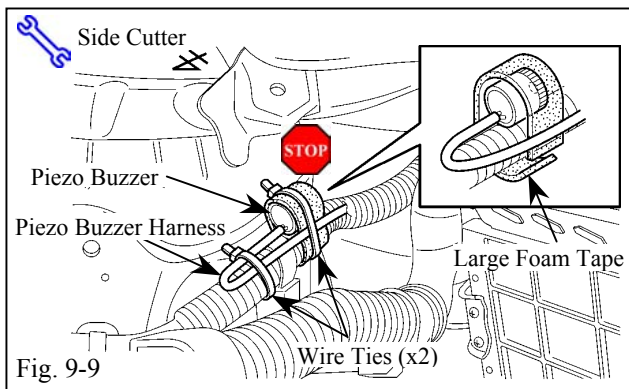

- (k) Wrap the Piezo Buzzer to the vehicle harness with one large foam tape. (Fig. 9-9)
 - (1) Do not cover the opening of the Buzzer with the foam tape.
 - (1) Secure the Piezo Buzzer to the vehicle harness with two wire ties. (Fig. 9-9)

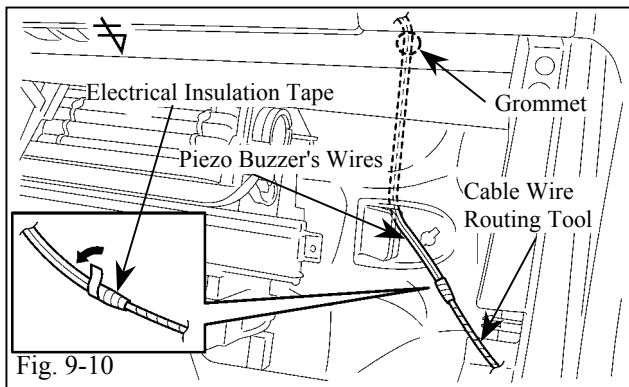

- (m) Route the cable wire routing tool and Piezo Buzzer's wires to the glove box area. (Fig. 9-10)
- (n) Remove the electrical insulation tape and cable wire routing tool. (Fig. 9-10)

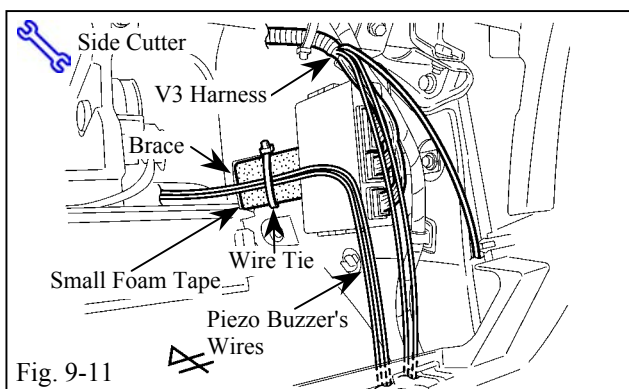

- (o) Attach one small foam tape to the brace as shown. Be sure the bolt and sharp edges are covered. (Fig. 9-11)
- (p) Route and secure the Piezo Buzzer's wires to the brace with one wire tie. (Fig. 9-11)

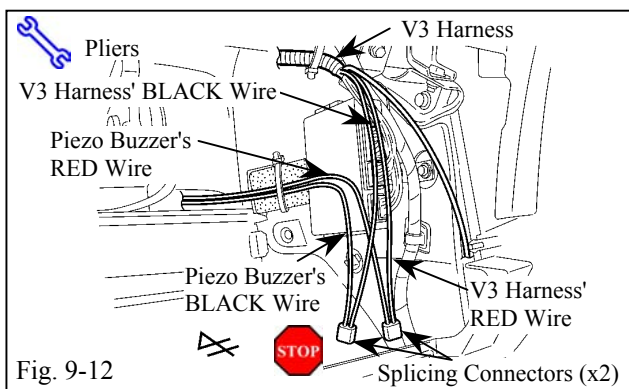

- (q) Attach the V3 harness' RED wire to the Piezo Buzzer's RED wire with one splicing connector. (Fig. 9-12)
- (1) Verify the correct wire is chosen for splicing.
- (2) Verify the splicing connector is applied properly.
- (r) Attach the V3 harness' BLACK wire to the Piezo Buzzer's BLACK wire with one splicing connector. (Fig. 9-12)

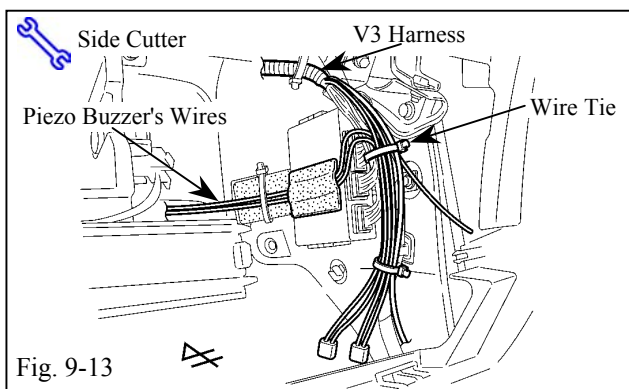

- (1) Verify the correct wire is chosen for splicing.
- (2) Verify the splicing connector is applied properly.
- (s) Secure the Piezo Buzzer's wires to the V3 ECU with one small foam tape. (Fig. 9-13)
- (t) Secure the V3 harness to the vehicle harness with two wire ties. (Fig. 9-13)

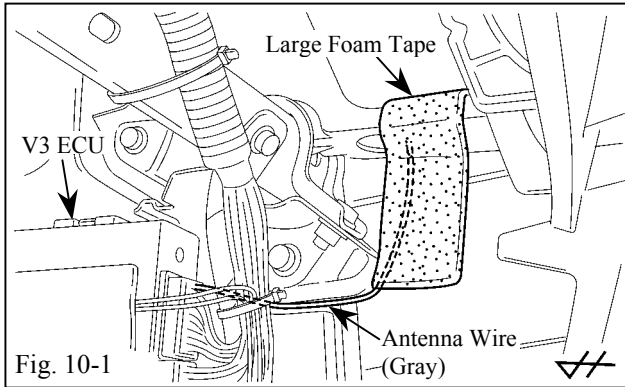

10. Antenna Wire Installation.

- (a) Secure the GRAY antenna wire to the side of the glove box area with one large foam tape. (Fig. 10-1)
 - (1) The GRAY antenna wire must be positioned as shown. If this position is not correct, remote control operation range will be shortened.

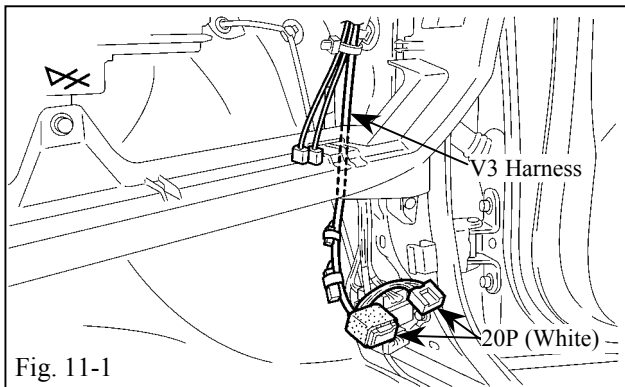

11. V3 Harness Installation. (Passenger's Cowl Area)

- (a) Route the V3 harness' white 20P connectors toward the passenger's cowl area. (Fig. 11-1)

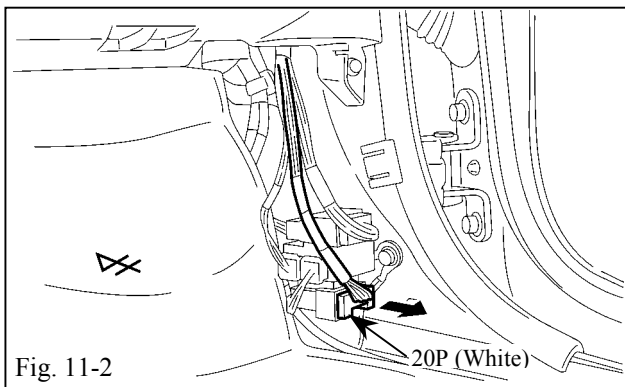

- (b) Locate and disconnect the white 20P connector from the passenger's cowl area. (Fig. 11-2)

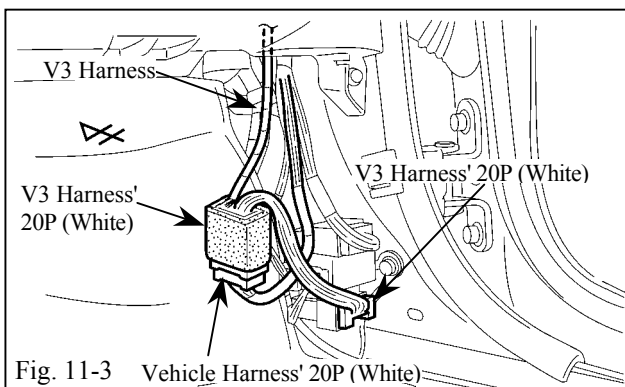

- (c) Plug in the V3 harness' white 20P connectors between the vehicle harness' white 20P connector and the connector block. (Fig. 11-3)
 - (1) Verify the connectors are plugged in securely.

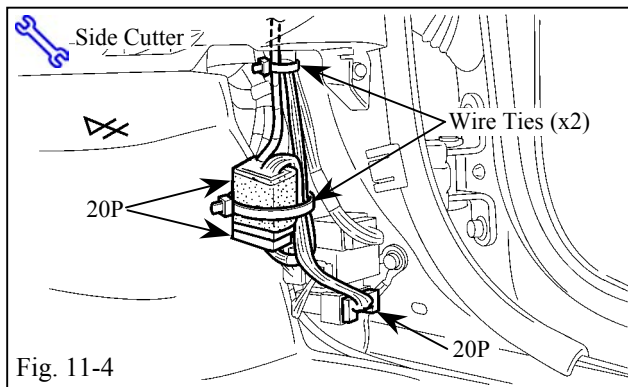

- (d) Secure the white 20P connectors to the vehicle harness with one wire tie. (Fig. 11-4)
- (e) Secure the V3 harness to the vehicle harness with one wire tie. (Fig. 11-4)

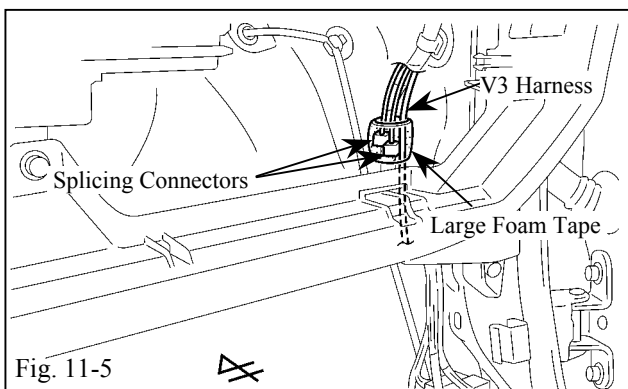

- (f) Secure the V3 harness and splicing connectors to the vehicle harness with one large foam tape. (Fig. 11-5)

12. Key Tag Installation.

- (a) Attach the key tag to the remote control key's ring. (Fig. 12-1)

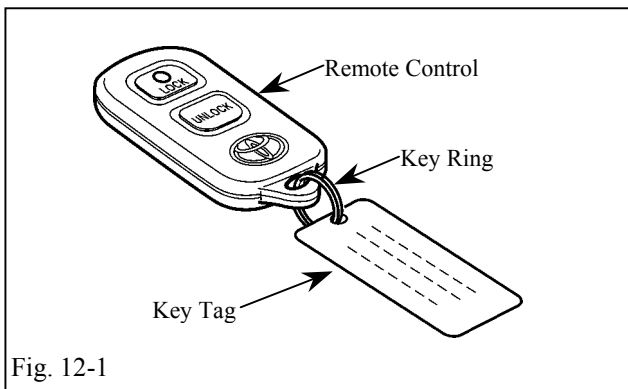

13. Warning Label Installation.

- (a) Using Household Windex, clean the inside surface of the front door windows. (Fig. 13-1)
- (b) Place the warning label on the inside surface of the front door's windows as shown. (Fig. 13-1)

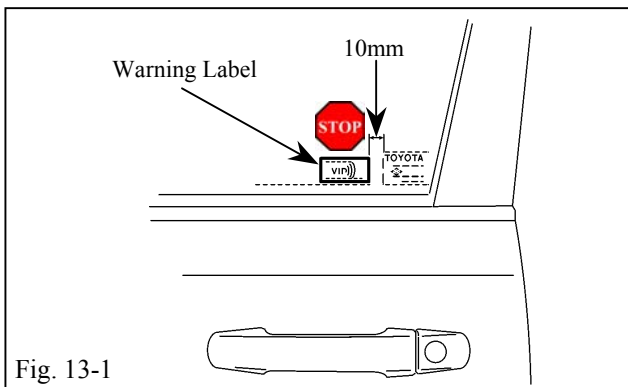

- (1) Use a piece of clean adhesive tape to lift the labels off their protective backing sheet.
- (2) Do not touch the adhesive surface of the warning labels.
- (3) Line up the labels properly and place on the glass once; do not use a label that was pulled off of the glass.



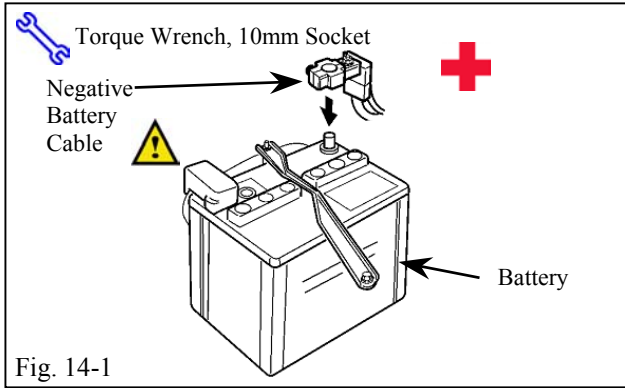

14. Completing the Installation.

- (a) Reconnect the vehicle's negative battery cable. (Fig. 14-1)
 - (1) Position the negative battery cable at the original factory position.
 - (2) Tighten the nut to 36 in-lbf \pm 1.5.
 - (3) Do not touch the positive terminal with any tool when replacing the cable.
- (b) Remove the appropriate fuse (Fig. 14-2)
- (c) Install dome fuse as shown. (Fig. 14-2)
- (d) Place the owner's manual, left in their protective bags, in the glove box

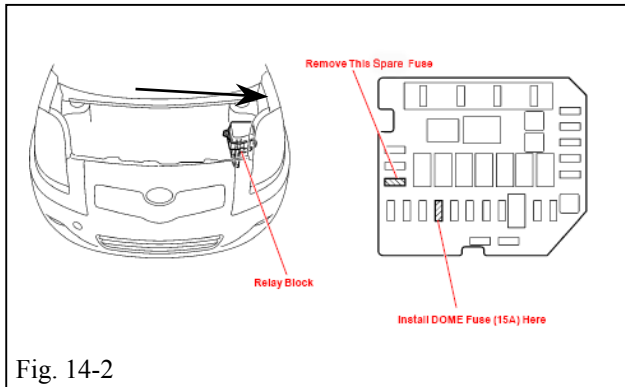

Checklist - these points **MUST** be checked to ensure a quality installation.

Check:

Look For:

Accessory Function Checks

Fit appropriate fuse before beginning.

Press and release the remote control's lock button to start the system's arming process.

Wait 30 seconds.

Press and release the remote control's unlock button to disarm the system.

Press and release the remote control's unlock button again within 3 seconds of disarming the system.

Open and close the driver's door.

Arm and disarm the system with the remote again, then wait 30 seconds.

Press and release the remote control's unlock button again to stop the arming process.

Open the driver's door, then press and release the remote control's lock button.

Close the driver's door.

1. The tail and marker lights flash once.
The buzzer chirps once.
All doors lock.

The Status Monitor's LED lights up.

2. After 30 seconds, the LED starts flashing; the system is now armed.

3. The tail and marker lights flash twice.
The buzzer chirps twice.
The driver's door unlocks.

The Status Monitor's LED stops flashing.

4. The tail and marker lights flash twice.
The buzzer chirps twice.
All remaining doors unlock.

5. The doors automatically relock.
The system automatically starts the arming process.

6. Refer to step 3.

7. The buzzer sounds continuously for 5 seconds.

8. The buzzer stops sounding.

Checklist - these points **MUST** be checked to ensure a quality installation.

Check:

Press and release the remote control's panic button to trigger the panic alarm.

Press and release the remote control's panic button again to stop the panic alarm.

Sit in the driver's seat and make sure all doors are closed.

Insert the key into the ignition switch and turn it to ON.

Roll down all the windows.

Turn the key back to LOCK.

Remove the key and exit the vehicle.

Insert the key into the driver's door key cylinder and turn it toward the front of the vehicle to start the arming process.

Wait 30 seconds.

Reach inside and manually unlock the driver's door.

Look For:

9. The horn sounds repeatedly.
The interior lights turn on.
The headlights flash repeatedly.
The tail and marker lights flash repeatedly.
The Status Monitor's LED lights up.

10. The horn stops sounding.
All the lights stop flashing and/ or turn off.

11. All doors lock.

12. All doors unlock.

13. All doors lock.
The Status Monitor's LED lights up.

14. After 30 seconds, the Status Monitor's LED starts flashing; the system is now armed.

15. The driver's door automatically relocks.
The horn sounds repeatedly.
The interior lights turn on.
The headlights flash repeatedly.
The tail and marker lights flash repeatedly.
The Status Monitor's LED lights up.

Checklist - these points **MUST** be checked to ensure a quality installation.

Check:

Manually unlock the driver's door again and hold it unlocked, open the door, then sit in the driver's seat.

Insert the key into the ignition switch and turn it to START to stop the alarm.

Turn the key back to LOCK, remove it, and then exit the vehicle.

With the door open, press the lock switch on the door to lock the doors, then close the door to start the system's arming process.

Wait 30 seconds.

Reach inside and manually unlock the front passenger's door to trigger an alarm.

Look For:

- 16. The driver's door attempts to lock repeatedly.
The horn continues to sound repeatedly.
The interior lights remain on.
The headlights, tail lights and marker lights continue flashing.
The Status Monitor's LED remains on.
- 17. The horn stops sounding.
All the lights stop flashing and/or turn off.
The Status Monitor LED turns off.
The starter cranks and the engine starts.
- 18. All doors lock.
The Status Monitor's LED lights up.
- 19. After 30 seconds, the Status Monitor's LED starts flashing; the system is now armed.
- 20. The front passenger's door automatically relocks.
The horn sounds repeatedly.
The interior lights turn on.
The headlights flash repeatedly.
The tail and marker lights flash repeatedly.
The LED lights up.

Checklist - these points **MUST** be checked to ensure a quality installation.

Check:

- Press and release the remote control's UNLOCK button to stop the alarm.

- Press and release the remote control's LOCK button to start the system's arming process, then wait 30 seconds until the system is armed.

- Unlock and open one of the rear passenger doors to trigger an alarm.

- Repeat the above steps with the other rear passenger and back door (if equipped).

Roll up all windows, remove the key and exit the vehicle.

- Press and release the remote control's lock button to start the system's arming process.

- Wait 30 seconds.

Perform the following check in a temperature-controlled environment (50° – 90° F.)

Look For:

- 21. The horn stops sounding.
All the lights stop flashing and/or turn off.
The Status Monitor's LED turns off.

- 22. Refer to steps 1 and 2.

- 23. Refer to step 9.

- 24. Refer to step 22 and 23.

- 25. Refer to step 1.

- 26. After 30 seconds, the Status Monitor's LED starts flashing; the system is now armed.

Checklist - these points **MUST** be checked to ensure a quality installation.

Check:



With the tip of a key (or Striker Tool pulled all the way out [PPO only]), tap the center of the driver's door window to trigger the "warn away" alarm.

Insert the key into the driver's door key cylinder and turn it toward the back of the vehicle to stop the alarm.

Look For:

- 27. The horn sounds repeatedly.
The headlights flash repeatedly.
The tail and marker lights flash repeatedly.
The Status Monitor's LED lights up.

NOTE: Adjust as necessary by increasing the GBS setting to the next level if the alarm does not trigger during the functional verifications.

NOTE: If you do not disarm the system, the alarm will last 20 seconds. *It is not necessary to check the alarm duration.*

- 28. The horn stops sounding.
All the lights stop flashing and/or turn off.
The Status Monitor's LED turns off.

Checklist - these points **MUST** be checked to ensure a quality installation.

<u>Check:</u>	<u>Look For:</u>
<u>Vehicle Function Checks</u>	
<input type="checkbox"/> Head Lights	Functioning Head Lights
<input type="checkbox"/> High Beams	Functioning High Beams
<input type="checkbox"/> Turn Signal Lights	Functioning Turn Signal Lights
<input type="checkbox"/> Tail Lights	Functioning Tail Lights
<input type="checkbox"/> Stop Lights	Functioning Stop Lights
<input type="checkbox"/> Backup Lights	Functioning Backup Lights
<input type="checkbox"/> Hazard Lights	Functioning Hazard Lights
<input type="checkbox"/> Marker Lights	Functioning Marker Lights
<input type="checkbox"/> Dome/Courtesy Lights	Functioning Dome/Courtesy Lights
<input type="checkbox"/> Panel/Switch Illumination	Functioning Controls/Illumination
<input type="checkbox"/> Accessory Controls/Illumination (if equipped)	Functioning Accessory
<input type="checkbox"/> Key Sensor Buzzer	Functioning Key Sensor
<input type="checkbox"/> Fog Lights (if equipped)	Functioning Fog Lights
<input type="checkbox"/> Daytime Running Lights (if equipped)	Functioning DR Lights
<input type="checkbox"/> Trunk/Tailgate/Bed Lights (if equipped)	Functioning Lights
<input type="checkbox"/> Glove Box Light (if equipped)	Functioning Glove Box Light
<input type="checkbox"/> Cruise Control Light (if equipped)	Functioning Cruise Control Light
<input type="checkbox"/> Seat Belt Warning Light	Functioning Seatbelt Warning Light. If the warning light remains ON, it may indicate a system malfunction.
<input type="checkbox"/> Air Bag Warning Light	Functioning Air Bag Warning Light. If the warning light remains ON, it may indicate a system malfunction.

Checklist - these points **MUST** be checked to ensure a quality installation.

Check:

ABS Light (if equipped)

- Lamp Failure Sensor (if equipped)
- Track/Skid Control Light (if equipped)
- HVAC
- Power Locks (if equipped)
- Power Windows (if equipped)
- Power Seats (if equipped)
- Power Sunroof (if equipped)
- Horn
- Gauges
- Front Wiper/Washer
- Rear Wiper/Washer (if equipped)
- Clock (if equipped)
- Accessory Power Socket (if equipped)
- Starter
- Audio/Video (if equipped)
- Power Sliding Door (if equipped)
- Convenience Memory Settings (if equipped)
- Heated Seats (if equipped)

Look For:

- Functioning ABS Light. If the warning light remains ON, it may indicate a system malfunction.
- Functioning Lamp Failure Light. If the warning light remains ON, it may indicate a system malfunction.
- Functional Track/VSC Light. If the warning light remains ON, it may indicate a system malfunction.
- Functioning HVAC Controls
- Functioning Power Locks
- Functioning Power Windows
- Functioning Power Seats
- Functioning Sunroof
- Functioning Horn
- Functioning Gauges
- Functioning Front Wiper/Washer
- Functioning Rear Wiper/Washer
- Functioning Clock
- Functioning Power Socket
- Functioning Starter
- Functioning Audio/Video
- Functioning Power Sliding Door
- Functioning Memory Settings
- Functioning Heated Seats

Checklist - these points **MUST** be checked to ensure a quality installation.

Check:

- Massage Seats (if equipped)
- Rear Window Defogger (if equipped)
- Power Side Mirrors (if equipped)
- Side Mirror Defogger (if equipped)
- Front Windshield Defogger (if equipped)
- Navigation System (if equipped)
- Rear Sunshade (if equipped)

Remove the appropriate fuse after checks are completed.

Look For:

- Functioning Massage Seats
- Functioning Rear Window Defogger
- Functioning Power Side Mirrors
- Functioning Side Mirror Defogger
- Functioning Front Windshield Defogger
- Functioning Navigation System
- Functioning Rear Sunshade