

TOYOTA

TUNDRA 2010 -

IMPACT SENSOR

Part Number: 00016-47031

Accessory Code: QG1



Kit Contents

Item #	Quantity Req'd.	Description
1	1	Security Interface Module
2	1	Shock Sensor
3	1	Main Harness
4	1	Hardware Bag
5	2	Anti-Theft Window Decals
6	1	Owner's Card
7		
8		

Hardware Bag Contents

Item #	Quantity Req'd.	Description
1	3	Red T-Tap Terminal
2	12	8" Black Cable Ties
3	1	Foam Mounting Pad
4	1	Red Scotchlok Connector
5		
6		
7		
8		

Conflicts

Vehicles without factory keyless.

Recommended Tools

Safety Tools	
Safety Glasses	
Vehicle Protection	
Special Tools	
Installation Tools	
Philips Screwdriver	Drill Motor
Ratchet with Extension	10mm Socket
Diagonal Wire Cutters	Common Pliers
Flashlight	Nylon Trim Tool
Torque Wrench 36 in-lb	
Special Chemicals	

Vehicle Service Parts (may be required for reassembly)

P/N	Qty.	Description
00016-47031-03	1	Interface Control Module
00016-30960-02	1	Shock Sensor Module
00016-47031-02	1	Miscellaneous Hardware Kit
00016-30960-03	2	Window Warning Decal
00016-47031-01	1	Wire Harness

General Applicability

--

Recommended Sequence of Application

Item #	Accessory	
1		
2		
3		

* Mandatory

Legend

STOP: Damage to the vehicle may occur. Do not proceed until process has been complied with.

OPERATOR SAFETY: Use caution to avoid risk of injury.

CAUTION: A process that must be carefully observed in order to reduce the risk of damage to the accessory/vehicle and to ensure a quality installation.

TOOLS & EQUIPMENT: Used in Figures calls out the specific tools and equipment recommended for this process.

REVISION MARK: This mark highlights a change in installation with respect to previous issue.

SAFETY TORQUE: This mark indicates that torque is related to safety.

SPECIAL NOTE: Installation Sequences

After TMS and Safety mandated preparatory steps have been taken, the installation sequence is the suggested method for completing the accessory installation. In some instances the suggested sequence is written for one associate to install and in others the sequence is given as part of a team accessory installation. Unless otherwise stated in the document, the associates may perform the installation steps in any order to make the installation as efficient as possible while maintaining consistent quality.

PREPARATION

INSTALLATION PREPARATION

Before starting installation:

1. Familiarize yourself with the installation instructions.
2. Inspect kit components.

VEHICLE PREPARATION

Verify that the vehicle shorting pin is installed prior to installation.

1. Place protective coverings on vehicle.
2. Disconnect negative battery clamp.
3. Remove the driver's side scuff plate by inserting a plastic panel tool under the scuff plate and prying upward to disengage the snap clips.

Optional Step: Insert a plastic tool under the front of the scuff plate and driver's side kick panel. Lift only that area.

4. Remove the nut that secures the driver's side kick panel.
5. Remove the driver's side kick panel by inserting a plastic panel tool under the kick panel and carefully prying to disengage the snap clips.
6. Remove the two 10mm bolts from either side of the driver's side finish panel. Pull the finish panel outward from the vehicle dash to disengage the snap clips.

NEGATIVE BATTERY CABLE

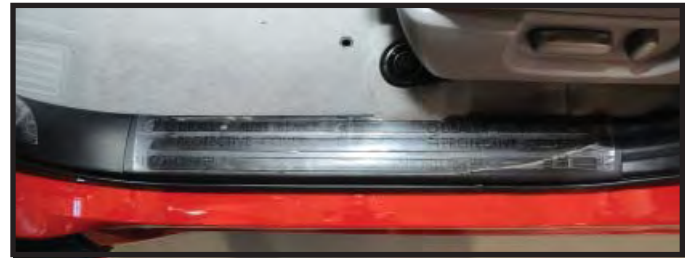
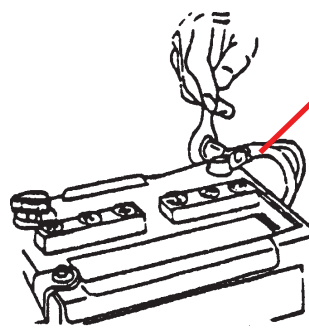

INSTALLATION PROCEDURES

T-TAP INSTALLATION

When installing female T-Tap connectors, be sure the wire is located inside the wire channel of the female T-Tap connector before closing the connector over the wire with pliers.

Step A



Step B

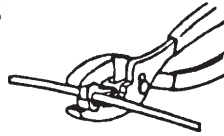

Step C



IMPORTANT! After installation, inspect and ensure that Keyless System Harnesses are clear of all HOT, SHARP or MOVING objects.

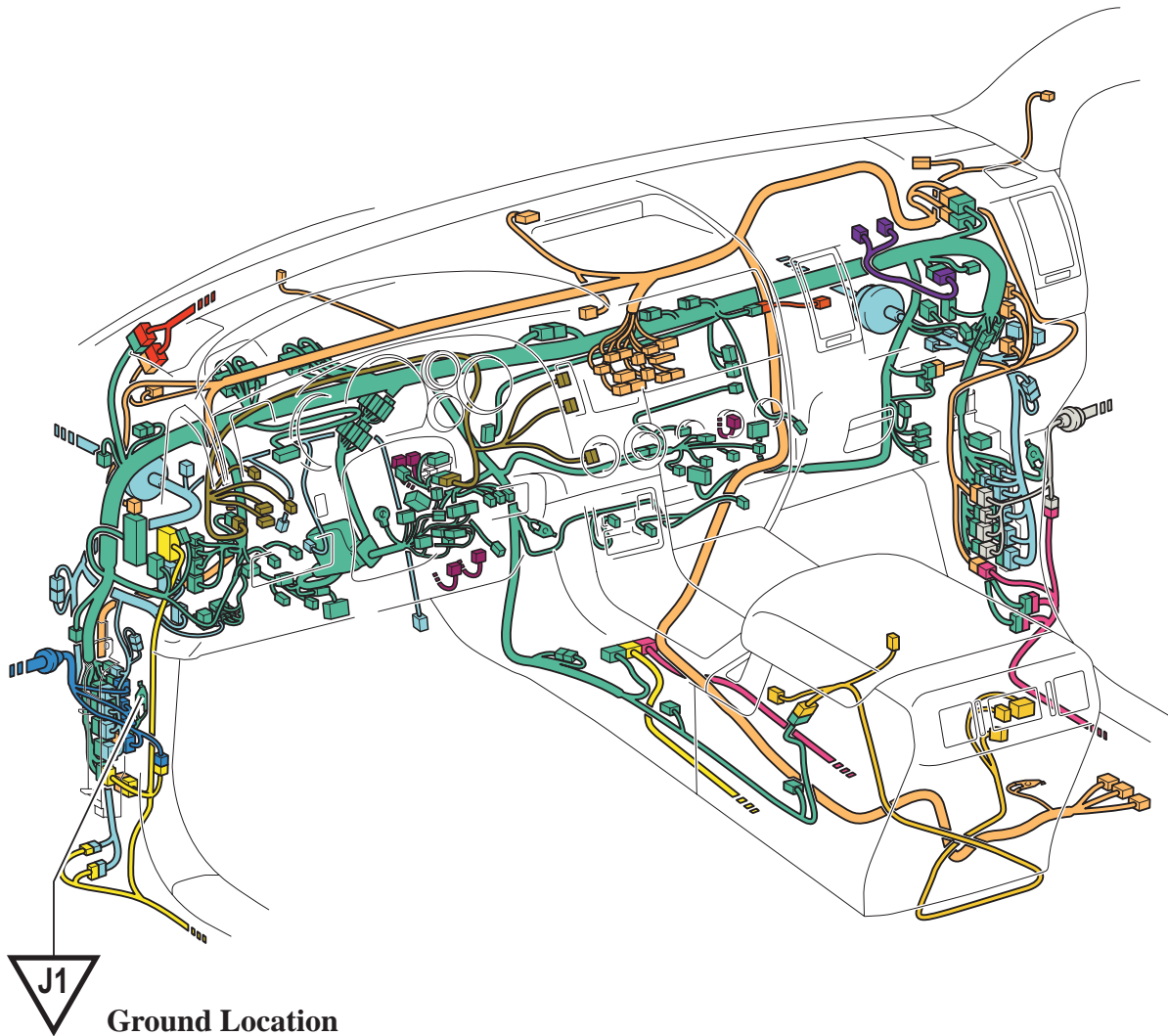

INSTALLATION PROCEDURES

INSTALLING THE SHOCK SENSOR

1. Secure shock sensor to wire loom running near the firewall, to the left of the brake pedal with (2) wire ties.
2. Plug in 4 cavity Molex connector from the main harness into the rear of the shock sensor.



Guide the cable ties through the module eyelets, as shown.



CABLE TIES

INSTALLING THE ALARM INTERFACE RELAY

1. Plug in 10 way Molex connector from the main harness into the Alarm Interface Relay.
2. Secure Alarm Interface Relay to factory harness running behind the driver's side air conditioning vent using (2) wire ties.



Carefully follow the wiring diagram and factory details on pages 4-5.



SECURING THE ALARM INTERFACE GROUND CONNECTION

Use the factory 10mm bolt to secure the alarm interface relay ground to the J1 ground point, shown on Page 3.



WIRING DIAGRAM

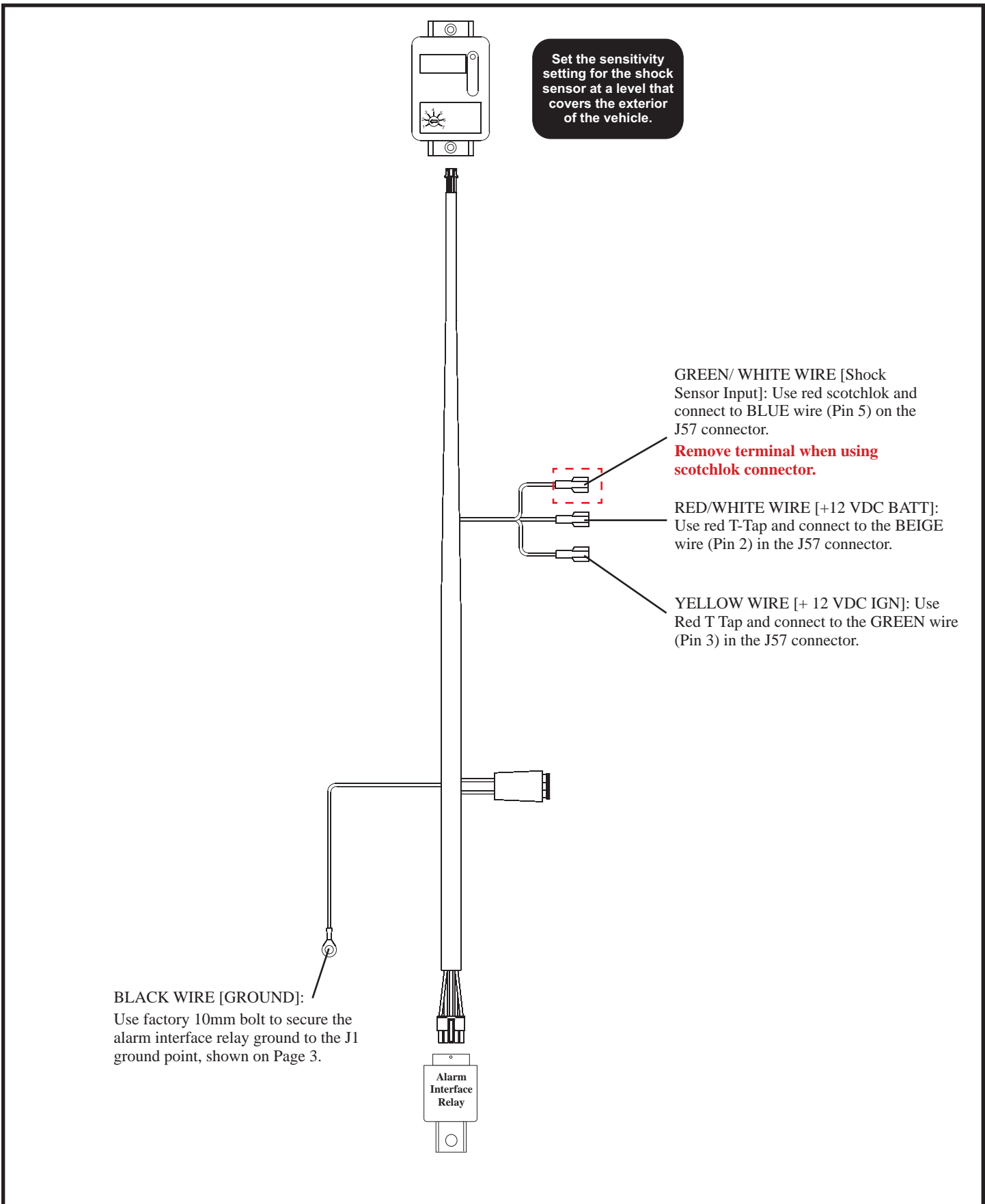

Set the sensitivity setting for the shock sensor at a level that covers the exterior of the vehicle.

GREEN/ WHITE WIRE [Shock Sensor Input]: Use red scotchlok and connect to BLUE wire (Pin 5) on the J57 connector.

Remove terminal when using scotchlok connector.

RED/WHITE WIRE [+12 VDC BATT]: Use red T-Tap and connect to the BEIGE wire (Pin 2) in the J57 connector.

YELLOW WIRE [+ 12 VDC IGN]: Use Red T Tap and connect to the GREEN wire (Pin 3) in the J57 connector.

BLACK WIRE [GROUND]: Use factory 10mm bolt to secure the alarm interface relay ground to the J1 ground point, shown on Page 3.

Alarm Interface Relay

CONNECTOR DETAILS

CONNECTOR J57

Location: Taped to Main Body ECU Harness

White Connector

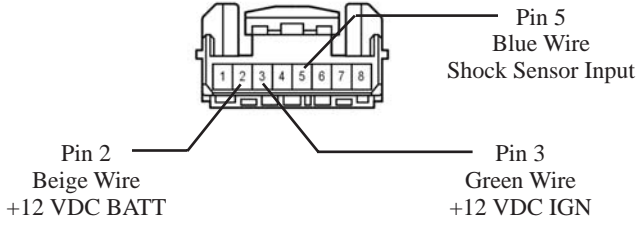

ALARM	CAR
Green/White	Blue
Yellow	Green
Red/White	Beige

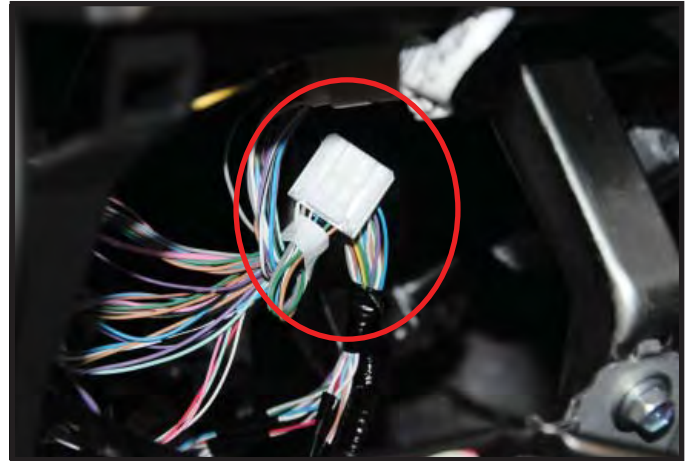

ACTIVATING THE SYSTEM

NOTE: Re-torque the battery cable to 36 in-lb once the process is completed.



Verify that the vehicle shorting pin is installed prior to testing.

NEGATIVE BATTERY CABLE

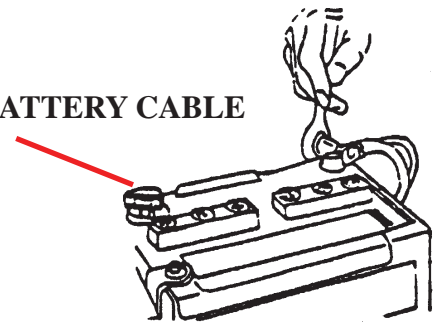

All vehicles must have the factory security option turned on. Use the TIS Techstream tool to activate the security option.

REGISTRATION

1. Connect the Techstream Notebook to the Vehicle's Diagnostic Port.
2. Insert key and turn ignition to the "ON" position.
3. Start the TIS Techstream Application by clicking on the shortcut located on the Desktop.
4. Click "Connect to Vehicle."
5. Confirm that the information displayed on the Vehicle Connection Wizard is correct for the vehicle. If not, verify that the Techstream is properly connected.
6. Click "Next >."
7. Click "Customize Setting."
8. Click ==>

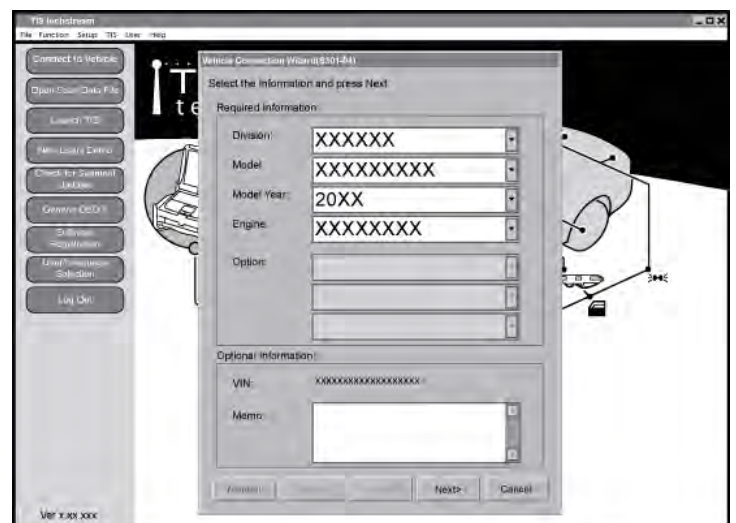
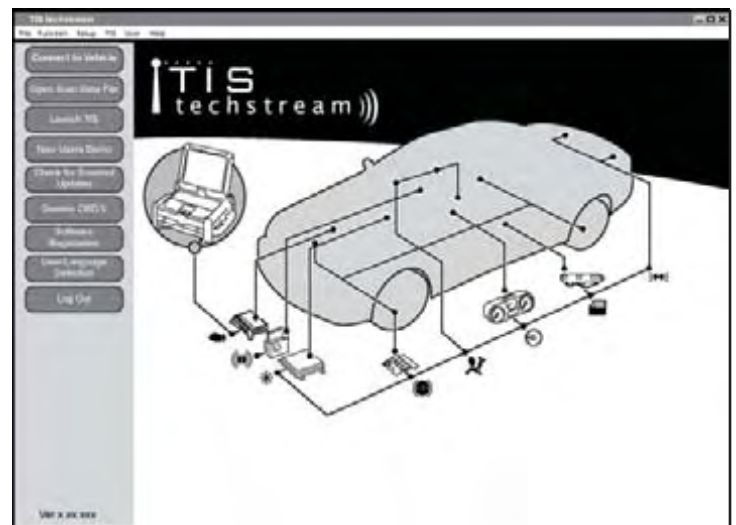

ACTIVATING THE SYSTEM

9. Make sure that the “Customize” tab is selected.
10. Select “Option Setup.”
11. Click ==>

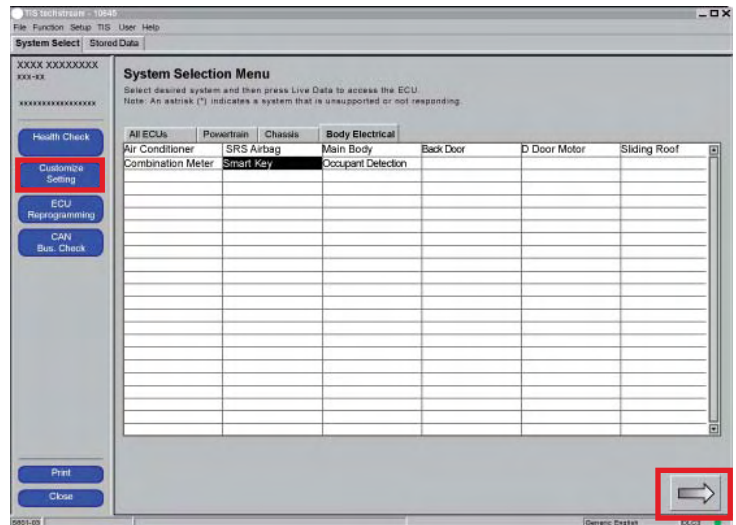

12. Select “ON.”
13. Click ==>

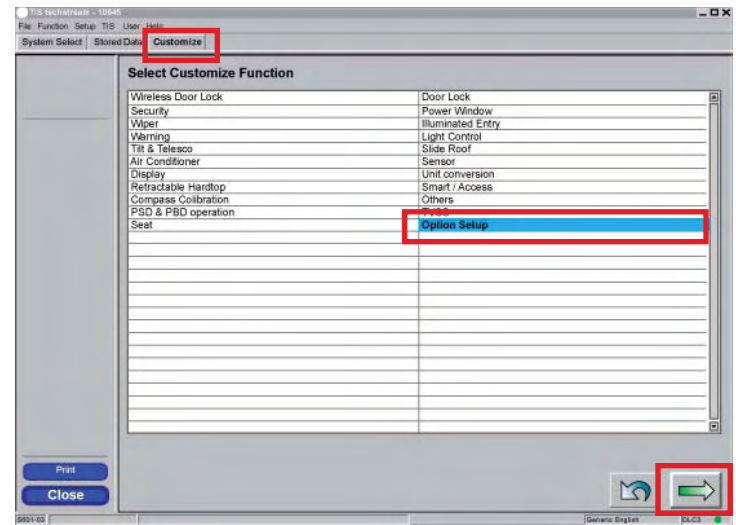

14. Click “Next” to accept the changes to the

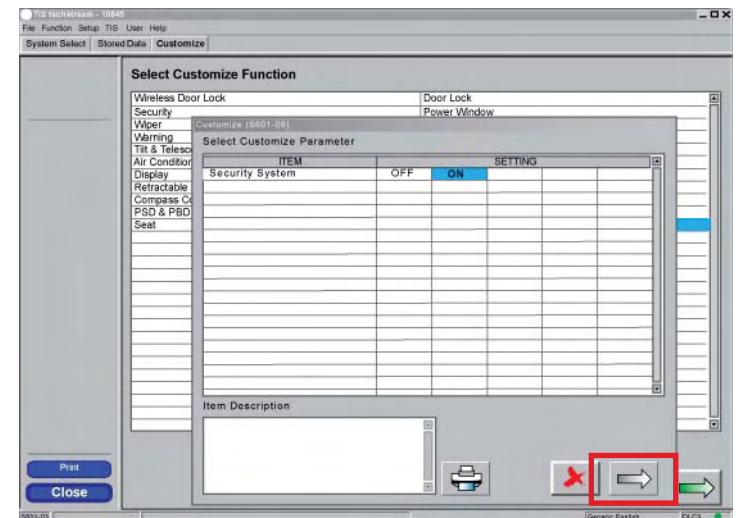

ACTIVATING THE SYSTEM

Vehicle.

15. Click ==>

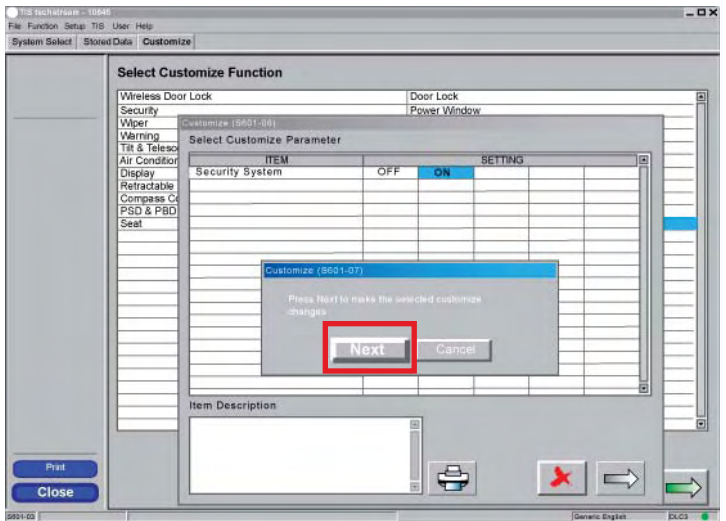

16. Click "Close."

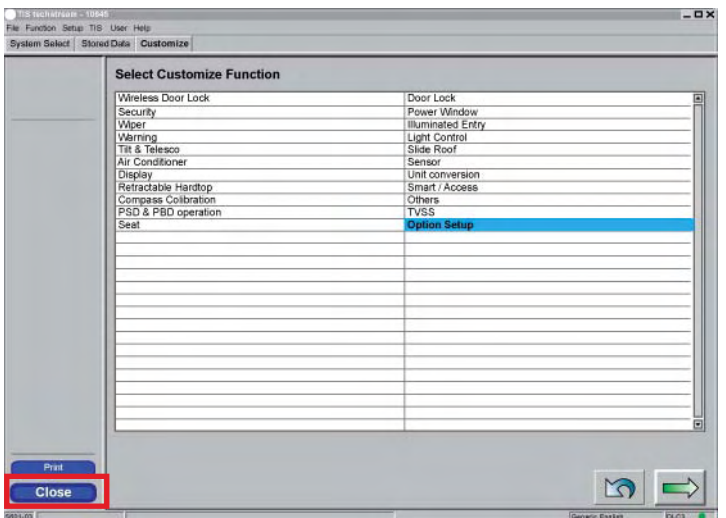
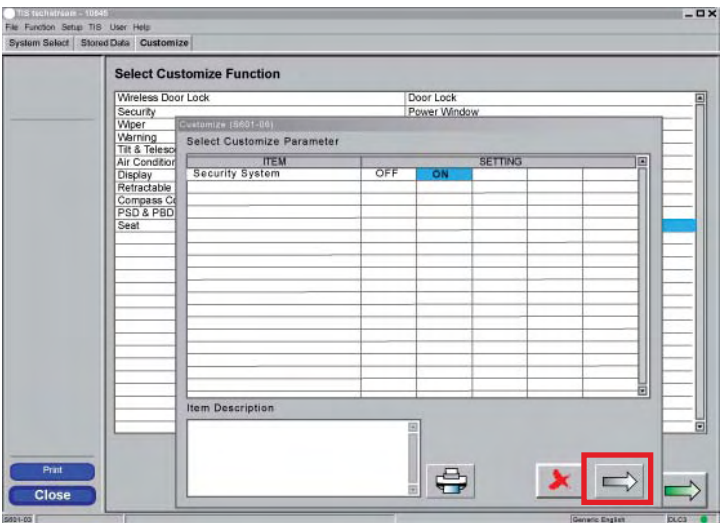

COMPLETING THE INSTALLATION

TESTING THE SYSTEM

1. Prior to delivering the vehicle, test all features of the factory system according to the vehicle's owner's manual.
2. Be sure to arm the system by pressing the LOCK button on the keyless entry transmitter. The factory security light will turn on solid for approximately 30 seconds, then begin to flash indicating the system is armed. At this time, deliver a firm strike to the driver's A Pillar with the open palm of the hand. The alarm should trigger as a result of the shock sensor.

ASSEMBLING ALL REMOVED PANELS TO THE VEHICLE

1. Refer again to the vehicle repair manual and reassemble all panels removed during installation back onto the vehicle.
2. Apply the window warning decals to the driver side and passenger side front windows, just above the anti - theft radio stickers if equipped. If not equipped, apply the decals at the lower rear edge of the window. The decals are reverse printed, and are applied to the inside surface of the glass.
3. Place owner's card in glove box.

VEHICLE FUNCTION CHECK

AFTER ALL PANELS, COVERS, AND COMPONENTS HAVE BEEN REINSTALLED, THAT WERE REMOVED, TEST THOROUGHLY, ALL MECHANICAL AND ELECTRICAL COMPONENTS DISCONNECTED AND OR REMOVED FROM THE VEHICLE DURING THE INSTALLATION OF THIS ACCESSORY.



VEHICLE FUNCTION CHECKLIST

THESE POINTS MUST BE CHECKED TO ENSURE A QUALITY INSTALLATION

- | | |
|---|---|
| <input type="checkbox"/> Head Light
<i>If the warning lights remains on, it may indicate a system malfunction.</i> | <input type="checkbox"/> Power Side Mirrors (if equipped) |
| <input type="checkbox"/> High Beams | <input type="checkbox"/> Side Mirror Defogger (if equipped) |
| <input type="checkbox"/> Turn Signal Lights | <input type="checkbox"/> Front Windshield Defogger (if equipped) |
| <input type="checkbox"/> Tail Lights | <input type="checkbox"/> Navigation System (if equipped) |
| <input type="checkbox"/> Stop Lights | <input type="checkbox"/> Rear Sunshade (if equipped) |
| <input type="checkbox"/> Backup Lights | <input type="checkbox"/> Cruise Control Light (if equipped) |
| <input type="checkbox"/> Hazard Lights | <input type="checkbox"/> Steering Wheel Audio Control (if equipped) |
| <input type="checkbox"/> Marker Lights | <input type="checkbox"/> HVAC |
| <input type="checkbox"/> Dome/Courtesy Lights | <input type="checkbox"/> Power Locks (if equipped) |
| <input type="checkbox"/> Panel/Switch Illumination | <input type="checkbox"/> Power Windows (if equipped) |
| <input type="checkbox"/> Accessory Controls/Illumination (if equipped) | <input type="checkbox"/> Gauges |
| <input type="checkbox"/> Rear Window Defogger (if equipped) | <input type="checkbox"/> Front Wiper/Washer |
| <input type="checkbox"/> Key Sensor Buzzer | <input type="checkbox"/> Hood Latch Release |
| <input type="checkbox"/> Fog Lights (if equipped) | <input type="checkbox"/> Passenger Air Bag Switch (if equipped) |
| <input type="checkbox"/> Day Time Running Lights (if equipped) | <input type="checkbox"/> Rollover Side Curtain Air Bag Switch (RSCA) |
| <input type="checkbox"/> Trunk/Tailgate/Bed Lights (if equipped) | <input type="checkbox"/> Horn |
| <input type="checkbox"/> Glove Box Light (if equipped) | <input type="checkbox"/> Seat Belt Warning Light
<i>If the warning light remains on, it may indicate a system malfunction.</i> |
| <input type="checkbox"/> ABS Light (if equipped) | <input type="checkbox"/> Air Bag Warning Light
<i>If the warning light remains on, it may indicate a system malfunction.</i> |
| <input type="checkbox"/> Rear Wiper/Washer (if equipped) | <input type="checkbox"/> Lamp Failure Sensor
<i>If the warning light remains on, it may indicate a system malfunction.</i> |
| <input type="checkbox"/> Clock (if equipped) | <input type="checkbox"/> Track/Skid Control Light (if equipped)
<i>If the warning light remains on, it may indicate a system malfunction.</i> |
| <input type="checkbox"/> Accessory Power Socket (if equipped) | <input type="checkbox"/> Tire Pressure Monitoring System (TPMS)
<i>Prior to TPMS activation and Pre-Delivery Service (PDS) of the vehicle the TPMS light will blink when IG is turned on. After TPMS activation and PDS of the vehicle the TPMS light will illuminate for a few seconds and go off when IG is turned on.</i> |
| <input type="checkbox"/> Starter | |
| <input type="checkbox"/> Audio/Video (if equipped) | |
| <input type="checkbox"/> Power Sliding Door if equipped) | |
| <input type="checkbox"/> Convenience Memory Settings (if equipped) | |
| <input type="checkbox"/> Heated Seats (if equipped) | |
| <input type="checkbox"/> Massage Seats (if equipped) | |