



**Southeast Toyota Distributors, LLC
Accessory Installation Instructions**

**2019 RAV4
Running Board**

Year & Model:	2019 Rav4
Part Number:	00016-42071; Anodized 00016-42081; Black
Accessory Code:	RB1300, RB1200
PIO / DIO:	PIO / DIO
Business Partner:	L50

Recommended Tools

Safety Items	
Safety Glasses	
Special Tools	
Installation Tools	
Torque Wrench	3/8" Drive
13mm Socket	Corresponding Drive Tool
10mm Socket	Corresponding Drive Tool
3" Socket Extension	Corresponding Drive Tool
10mm Wrench	Open/Box
Special Chemicals	
None	

Conflicts

None

General Applicability

Fits Models:	
1.	All 2019 Models
2.	
3.	

Additional Items Required For Installation

Item#	Description:
1.	Torque Audit Sheet, PIO Only. Note: For PIO Install Using Atlas Copco Torque Management Equipment , See Torque Procedures

Sequence of Application

Item#	Accessory:
1.	

SPECIALNOTE: Installation Sequences
After TMS & Safety mandated preparatory steps have been taken, the installation sequence is the suggested method for completing the accessory installation. In some instances the suggested sequence is written for one associate to install & in others the sequence is given as part of a team accessory installation. Unless otherwise stated in the document, the associates may perform the installation steps in any order to make the installation as efficient as possible while maintaining consistent quality.

Legend

	STOP: Damage to the vehicle may occur. Do not proceed until process has been complied with.
	OPERATOR SAFETY: Use caution to avoid risk of injury.
	CAUTION: A process that must be carefully observed in order to reduce the risk of damage to the Accessory/vehicle and to ensure a quality installation.
	TOOLS & EQUIPMENT: Used in Figures calls out the specific tools and equipment recommended for this process.
	REVISION MARK: This mark highlights a change in installation with respect to previous issue.
	SAFETY TORQUE: This mark indicates that torque is related to safety.
	VIDEO: This image indicates a video to show a installation procedure, PIO only.

Table of Contents

- I. Preparation.....1-5
 - a. Table of Contents..... 2
 - b. Kit/Hardware Bag Contents..... 3
 - c. Parts for Installation..... 4
 - d. Service & Warranty Information..... 5

- II. Procedures
 - a. Preparation of Vehicle.....6-7
 - b. Installation Process..... 8-9
 - c. Installation Running Boards..... 10

- III. Vehicle Function & Quality Checks.....11
- IV. Atlas Copco Torque Procedures.....12
- V. Warranty Statement.....13-14

Kit/Hardware Bag Contents:

Item #	Quantity	Description
1.	1	Driver Side Left Side Running Board
2.	1	Passenger Side Right Side Running Board
3.	12	Mounting Brackets
4.	12	Frame Locking Bolts
5.	12	Aluminum Spacers
6.	14	Nylon Retaining Washers (2 extra)
7.	12	M8 1.25 Serrated Flange Nuts
8.	12	M6 1.0 x 16mm Flange Bolts
9.	12	M6 1.0 Serrated Flange Nuts

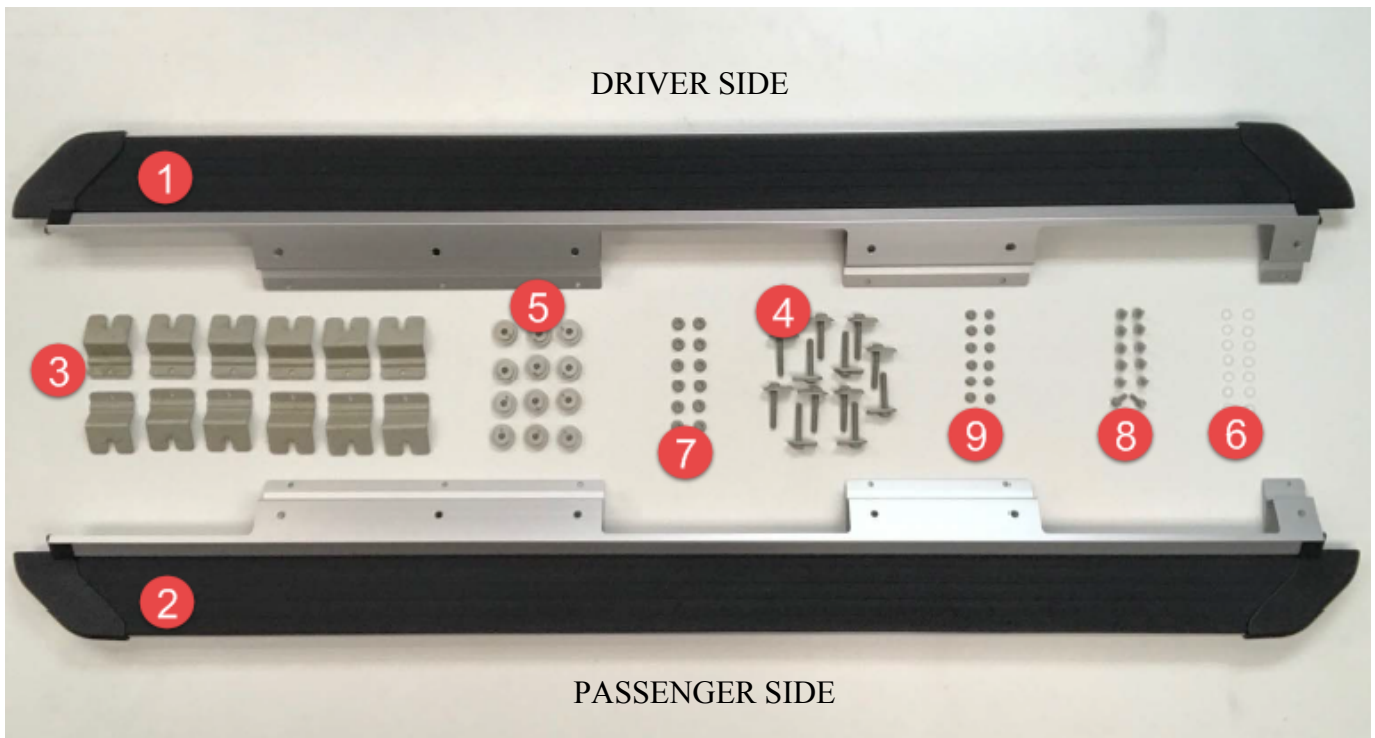

Parts for Installation:

Care must be taken when installing this accessory to ensure damage does not occur to the vehicle. The installation of this accessory should follow approved guidelines to ensure a quality installation. These guidelines can be found in the “Accessory Installation Practices” document.

This document covers such items as:

- Vehicle Protection (use of covers and blankets, cleaning chemicals, etc.).
- Safety (eye protection, re-checking torque procedure, etc.).
- Vehicle Disassembly/ Reassembly (panel removal, part storage, etc.).
- Electrical Component Disassembly/Reassembly (battery disconnection, connector removal, etc.).

Item #	Quantity	Description
1.	1	Drivers Side Running Board Assembly
2.	1	Passengers Side Running Board Assembly
3.	1	Mounting Brackets
4.	1	Hardware Bag

Service & Warranty Information:

Image Key	Parts information		Warranty Information	
	Part Number	Description	Warranty Time	Labor Op. Code
N/A	00016-42071 00016-42081	19RAV4 ANODIZED RB 19RAV4 BLACK RB	N/A	N/A
1	00016-42071-01 00016-42081-01	LFT FR/RT RR 1-PIECE	0.5	ATR011
2	00016-42071-02 00016-42081-02	RT FR/LFT RR 1-PIECE	0.5	ATR011
3	00016-42071-03 00016-42081-03	Left Side End Caps (1 Side)	0.2	ATR031
4	00016-42071-04 00016-42081-04	Right Side End Caps (1 Side)	0.2	ATR031
5	00016-42071-05 00016-42081-05	Hardware (Full Kit)	0.5	ATR021
6	00016-42071-06 00016-42081-06	Jack Block Hardware	0.5	ATR021
N/A	00016-42071-07 00016-42081-07	STEP PAD 1-SIDE ONLY	0.2	ATR031

Note: Combo Code A applicable to ATR011 and ATR021 for additional 0.2 hours when replacing both sides. Combo Code A applicable to ATR031 for additional 0.1 hours when replacing both end caps or step pads.

If you are a dealer located outside of the Southeast Region, please contact the SET Accessory Warranty Department at (888) 851-2722 or email Accessory.Warranty@SEToyota.com for claim payment instructions.

Image is Anodized or Black Board



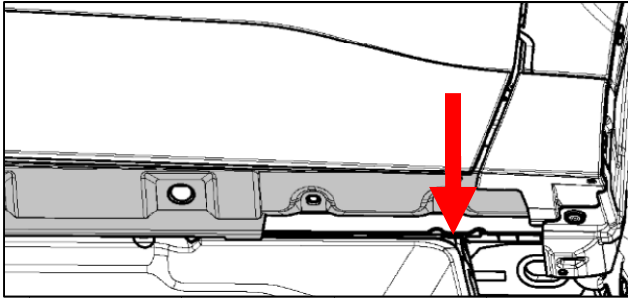

Fig. 1a.

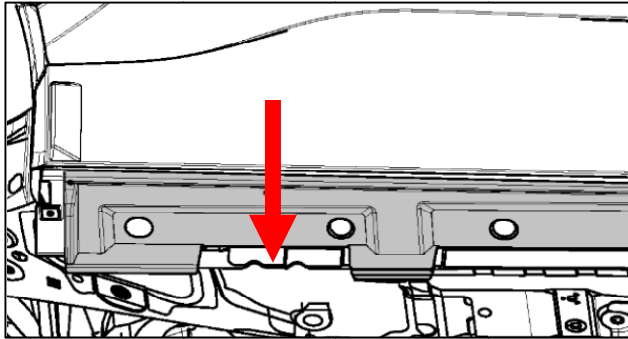

Fig. 1b.

1. Vehicle Preparation:

- +** (a) The running board is designed to be installed with the use of a 2-post lift. Ensure that the lift pad is properly centered on the pinch weld Jacking Points before lifting the vehicle (Fig 1a, 1b.)

2. Disassembly: Removing Rocker Cover Plugs

- +** (a) Working under a vehicle requires installer to wear safety glasses.
- (b) There are 6 total Rocker Cover retaining plugs per side to be removed. Figs. 2-a. and 2-b shows the retaining plugs. (circled in red)
- (c) **Do not remove the two plugs** circled in blue (Fig. 2a, & 2b.)

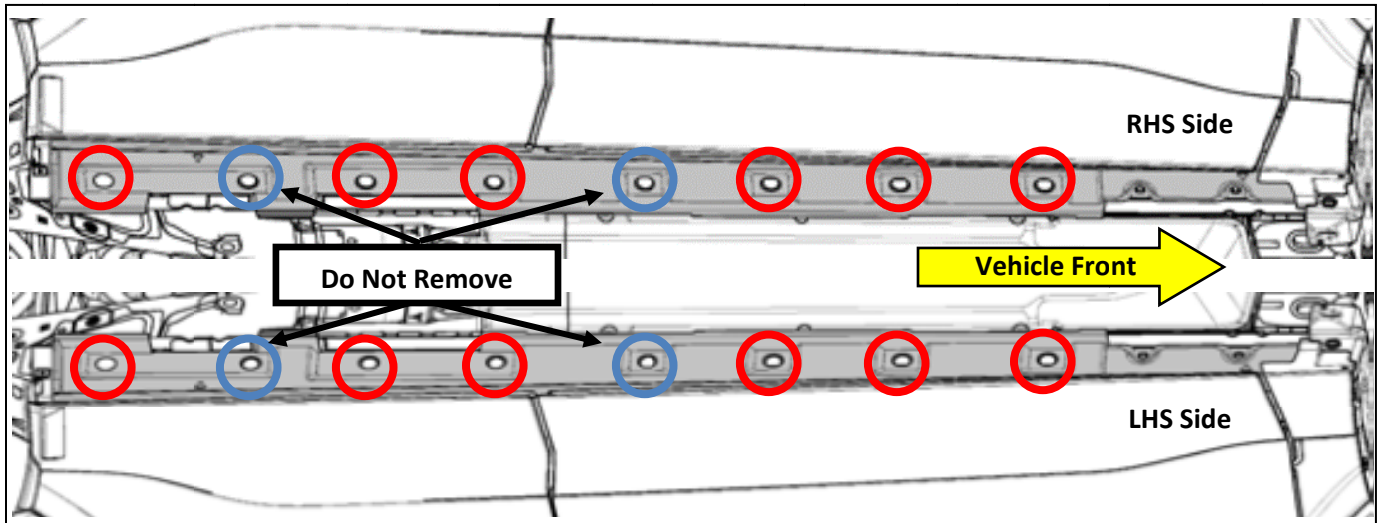

Fig. 2a.



Fig. 2b.

- (d) To avoid damage to the plastic Rocker Cover, grip the rocker cover on either side of the retaining plug where possible and pull down to remove the retaining plug (Fig 2b).

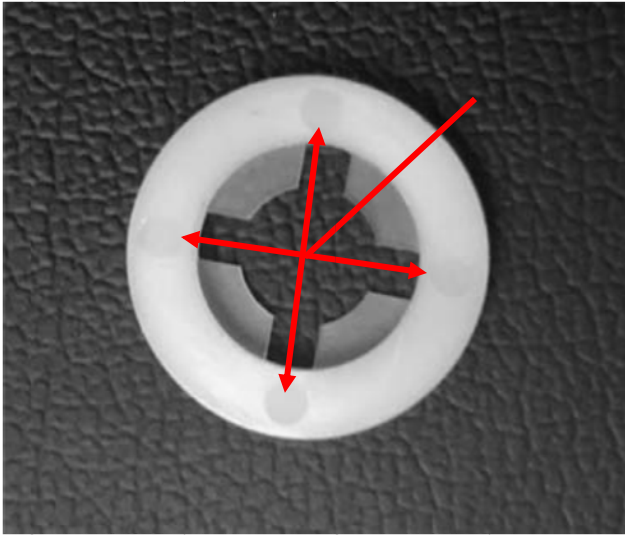

Fig. 3a.

3. Preparation: Frame Locking Bolt Assembly



- (a) The nylon retaining washer should be orientated with the Dot Markings facing downward Fig. 3a.
- (b) Assemble the Frame Locking Bolt as shown in fig. 3b.
- (c) There should be roughly 15mm of space between the end of the nylon retaining washer and the end of the frame locking bolt.
- (d) The nylon washer's locking tabs should not extend past the spacer when placed on the frame locking bolt. Orientation is highlighted in Fig 3b.

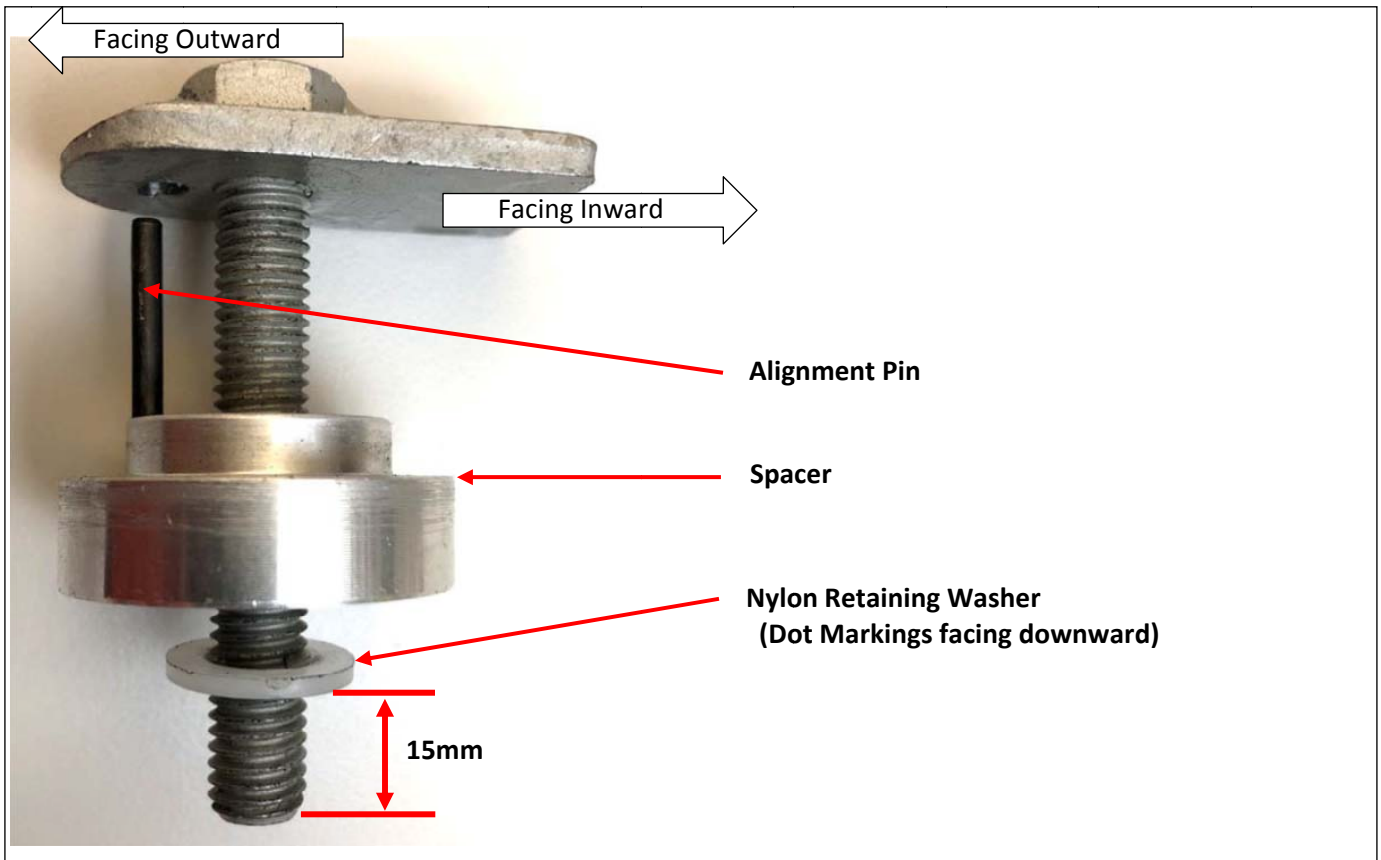

Fig. 3b.



4. Installation Process

- (a) Insert the frame locking bolt assemblies into the 6 open Rocker Panel holes (Fig. 4).

NOTE: It's easier if the inward facing tab of the assembly is facing either front or back of the vehicle.



- (b) Orient the Frame locking bolt with the inward facing tab facing inward as previously shown in Fig. 3b.

Fig. 4



- (c) To insert the Mounting Brackets, pull the plastic rocker panel down and away from body (Yellow arrow), and insert bracket between the sheet metal and the plastic rocker panel (Red arrow, Fig. 5).

NOTE: The frame locking bolt and alignment pin must sit in the cutout section of the bracket.

Fig. 5



- (d) The two Mounting Bracket dimples must sit within the rocker panel retaining plug hole (RED star outline). To check, the bracket will not slide side to side when installed properly (Fig. 6).

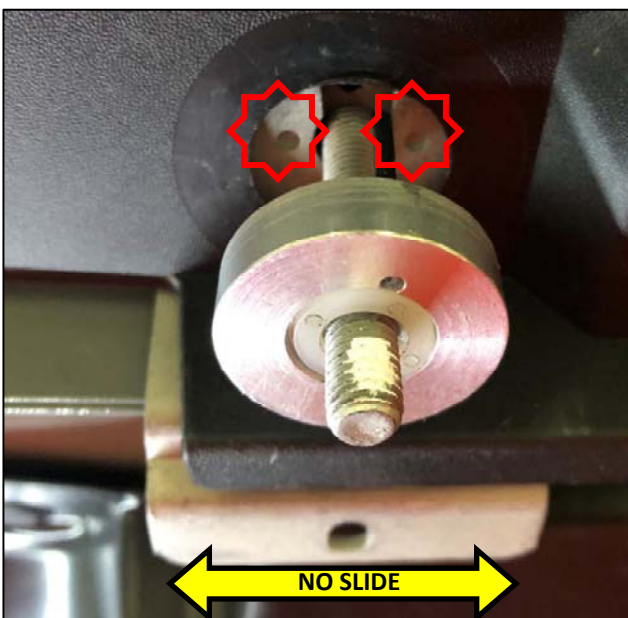

Fig. 6



Fig. 7



(e) Line up the alignment pin on the spacer with the hole in the Frame Locking Bolt (Fig. 7). The paint mark on the bolt will be facing outboard to help you align the pin to bolt.

(f) Use a small wrench (10mm) to fully push the nylon locking washer up the frame locking bolt (Fig. 8).

NOTE: Smaller step of the spacer should sit inside the plastic rocker panel hole.

NOTE: The smaller step of the spacer should be flush against the metal bracket (Fig. 9).

(g) Repeat steps 3 and 4 for the rest of the mounting points.



Fig. 8

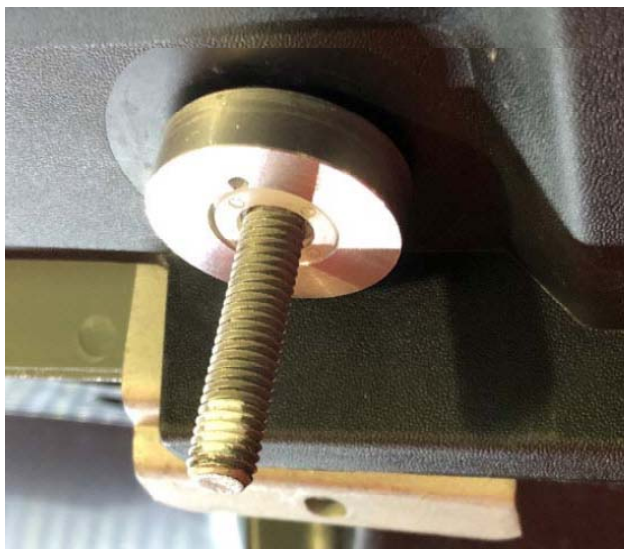
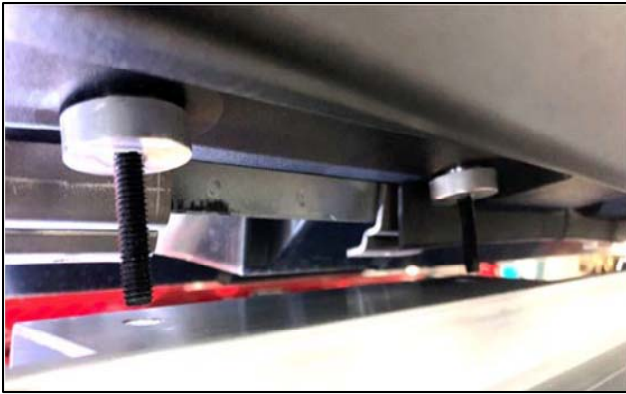

Fig. 9



5. Install Running Board

- (a) Before installing the running board, ensure that the unused panel retaining holes have the plugs installed (See previously Fig. 2a).
- (b) Align the running board mounting holes to the installed frame locking bolts and slide up into position (Fig. 10)

Fig. 10

- (c) Thread all 6 of the M8 flange nuts onto the frame locking bolts but, do not tighten. Leave brackets with enough slack to align M6 bolt holes (Fig. 11)



Fig. 11

- (d) Insert all 6 of the M6 bolts through the bracket and running board and thread all 6 of the nuts. Ensure that the bolts are inserted from the top and **are pointing downward**.

NOTE: The use of a non-impacting type electric hand tool can be used to drive the nuts up and into place so long as the nut does not reach or exceed the specified torque.

6. Torquing of Bolts.

- ▽ (a) Torque all fasteners to rocker panel to 17 lbs-ft (23 Nm)

Torque: 23 Nm (17 ft-lbf)

- ▽ (b) Torque all brackets to running board fasteners to 10 lbs-ft (13.5 Nm).

Fig. 12

Torque: 13.5 Nm (10 ft-lbf)

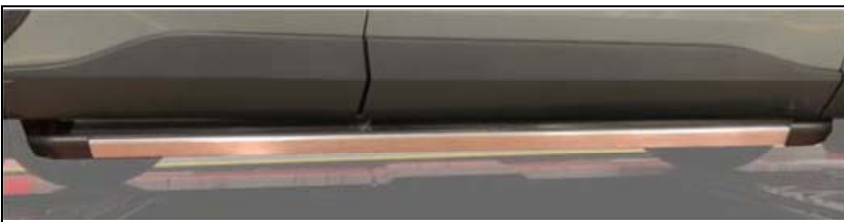
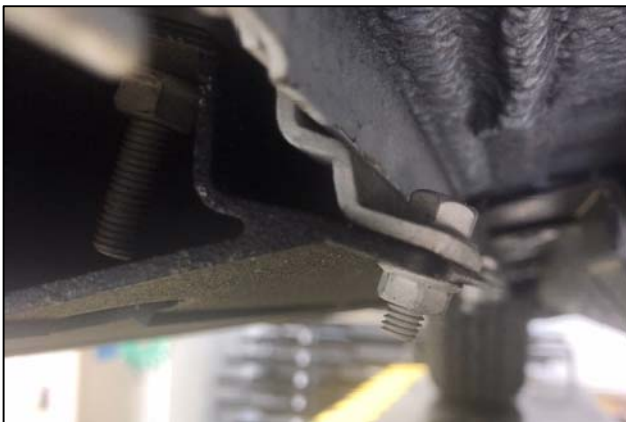

NOTE: The installation of the running board should look like Fig 13. There is a gap between the bottom of the door and the top surface of the running board and gets larger towards the rear of the vehicle. This is normal.

Fig. 13

- 7. Print Warranty Statement and place in glove box, DIO Only.

8. Complete Installation of Running Board:

- (a) Repeat Steps 2-5 to install the RHS running board side.

Vehicle Function & Quality Checks:

CHECKLIST - these points MUST be checked to ensure a quality installation.

Check after installation:

Look for:

-  Inspect bolt torque

Complete torque audit sheet within 5 minutes after re-torquing.

-  Board alignment & tighten properly.

 Torque bolts to target of 17ft/lbs
(-25% + 50%) 12.75 min / 25.5 max ft. lbs.

Torque bolts to target of 10ft/lbs
(+/- 25%) 7.5ft. lbs / 12.5 max ft. lbs.

-  Verify that there is no interference with front Mud Guard.

No touching of board to Mud Guard.

-  Vehicle Appearance Check:

After accessory installation and removal of protective cover(s), perform a visual inspection.

Ensure no damage (including scuffs and scratches) was caused during the installation process.

(For PPO installations, refer to TMS Accessory Quality Shipping Standard.)

-  Warranty Statement

Place Warranty Statement to glove box, DIO Only.



FIG 1

Front of Vehicle

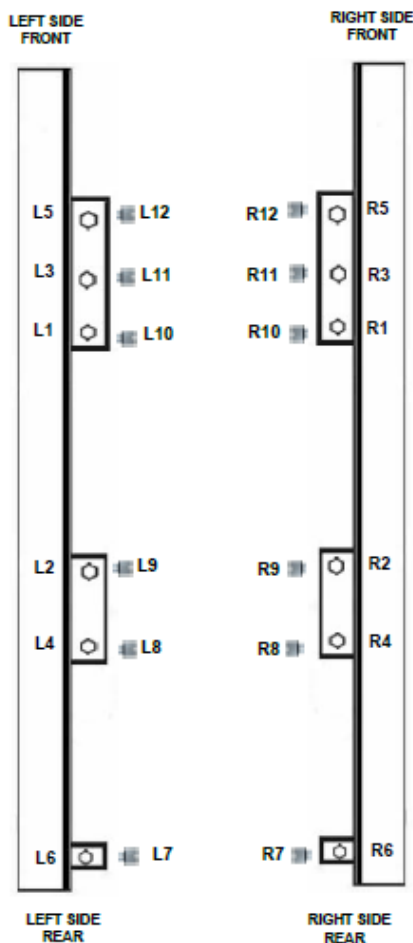

FIG 2

Step Board Torque Procedure

- 1) Hand start all fasteners and flat washers per the installation guide.
- 2) Prior to final torque sequence, ensure that the brackets positioned flush on the vehicle.
- 3) Scan identifiers in the following order. Visually confirm correct entries in controller and flashing red light turns on.
 - a) Part Number
 - b) VIN (Door Jam Only)
- 4) Torque all fasteners per the installation guide.
- 5) Once job is complete verify the batch count is complete and the Green Light is on.

Silver

Part Number: 00016-42071



Black

Part Number: 00016-42081



LIMITED WARRANTY – SOUTHEAST TOYOTA

SOUTHEAST TOYOTA DISTRIBUTORS, LLC (“we,” “our” and “us”) provides the following limited warranty on our accessories, excluding tires, (“Accessories” or “Accessory”) installed on a Toyota. This limited warranty is not provided by and does not bind or provide benefit to the vehicle dealer, the manufacturer, or Toyota Motor Sales, U.S.A., Inc. This limited warranty does not apply to tires; please consult the tire manufacturer and/or its materials accompanying the vehicle for any warranty terms concerning tires. This limited warranty also does not apply to ToyoGuard Exterior Paint Sealant and ToyoGuard Interior Protector; please consult the ToyoGuard Limited Warranty Certificate for the warranty terms concerning those products.

SCOPE OF LIMITED WARRANTY:

A. Protection:

- i. **Accessories Installed by Southeast Toyota Distributors, LLC on a new Toyota vehicle.** We warrant that, for a period of 36 months or 36,000 miles, whichever occurs first, we will repair or replace (includes labor), free of charge, any defect in such an Accessory due to faulty material or workmanship, or, at our option, provide a full refund of the purchase price of the Accessory. The warranty period begins on the vehicle's In-Service Date, which is the first date the new vehicle is either delivered to an ultimate purchaser, leased, or used as a company car or demonstrator. Accessories installed by Southeast Toyota Distributors, LLC are identified on the vehicle's window sticker (Monroney Label).
- ii. **Accessories Installed by a Toyota Dealer on a Toyota vehicle.** We warrant that, for 12 months, regardless of mileage, from the date such an Accessory was installed on the vehicle or the remainder of the Toyota new vehicle warranty, whichever is longer, we will repair or replace (includes labor), free of charge, any defect in the Accessory due to faulty material or workmanship, or, at our option, provide a full refund of the purchase price of the Accessory. For a new vehicle, the warranty period begins on the vehicle's In-Service Date, which is the first date the new vehicle is either delivered to an ultimate purchaser, leased, or used as a company car or demonstrator.
- iii. **Accessories purchased from a Toyota Dealer but not installed by the Toyota Dealer.** We warrant that, for a period of 12 months, regardless of mileage, from the date the accessory was purchased, we will repair or replace (does not include labor), free of charge, any defect in the Accessory due to faulty material or workmanship, or, at our option, provide a full refund of the purchase price of the Accessory.

B. Limitation of Warranty. This limited warranty does not apply to, and we will not repair, replace, or reimburse you for: (1) wheel balancing and wheel alignments, except for one wheel balancing or alignment during the first 12 months or 12,000 miles, whichever occurs first, from the vehicle's In-Service Date, as defined above, (2) abrasions or dents, whatever their cause, and any failure or damage resulting directly or indirectly from accidents, collisions, impacts from foreign objects, fire, theft, larceny, explosion, malicious mischief, vandalism, civil commotion, riots, war, or any other similar causes, (3) any failure or damage resulting directly or indirectly from lightning, windstorms, hail, water, floods, subfreezing temperatures, airborne chemicals, tree sap, dust, salt, and any other environmental conditions or similar causes, (4) any failure or damage caused by: (a) a failure of any part, other than the Accessory, (b) any misuse, abuse, improper towing, negligence or lack of maintenance of the vehicle or Accessory, (c) the alteration, modification or repair of the Accessory by anyone other than persons expressly authorized by us to perform such alteration, modification or repair, or (d) the use of the vehicle for commercial purposes, competitive driving or racing, (5) any failure or damage, if the Accessory has not been installed according to instructions, (6) any failure or damage occurring outside of Canada, the United States of America, its territories or possessions, (7) except to the extent required by the state whose laws govern this limited warranty, any consequential, secondary, or unreasonable costs that may be suffered as a result of the need to repair or replace the Accessory, including without limitation any loss of use of the vehicle, road service, towing, storage charges, inconvenience, loss of wages and/or income, additional expense incurred, loss of transportation, rental car expense, or any derivative damage to persons or things other than the Accessory, including other parts of the vehicle, or (8) liability for damage to property or for injury to or death of any person, arising out of the operation, maintenance or use of your vehicle whether or not related to the covered Accessory.

C. Exclusive Remedy. If there is a valid claim under this limited warranty for a defect due to faulty material or workmanship in the Accessory, we will, at our option, either: (i) repair, (ii) replace or (iii) provide a full refund of the purchase price of the Accessory. We have no other obligations under this limited warranty. Refunds will be made to the vehicle owner. If the vehicle is leased, the refund will be made to the leasing company.

HOW TO MAKE A CLAIM: In the event of a warranty claim, please contact the nearest Toyota dealer to arrange for repairs. The dealership must receive our prior authorization before making repairs covered by this limited warranty. The dealer will contact Southeast Toyota Distributors, LLC at 1-888-851-2722, select option #5 (Warranty Department), then option #4 (Repairs), for instructions on processing a warranty claim, if they are not already familiar with the process. If you have any questions or concerns regarding repairs covered by this limited warranty, please contact our Customer Assistance Hotline at 1-800-301-6859.

OUR DISPUTE RESOLUTION PROGRAM: Your satisfaction is our highest priority. In keeping with that focus, in the event that an issue arises related to this Limited Warranty, we invite you to call our Customer Assistance Hotline at 1-800-301-6859 to discuss it. In most cases, we expect that a satisfactory resolution of your issue can be reached through engagement with that Department. If our Customer Loyalty Department is unable to resolve your issue to your satisfaction, we offer a dispute resolution program administered by the National Center for Dispute Settlement (NCDS) (“the Program”). The purpose of the Program is to resolve disputes in an informal setting before an impartial arbitrator. The Program is free of charge to you (although you must bear the cost of any expert witness or attorney you elect to employ). You are required to complete the Program before exercising rights or seeking remedies under the federal Magnuson-Moss Warranty Act, 15 U.S.C. § 2301 et seq. (“the Act”). If you choose to seek remedies that are not created by the Act, you are not required to use the Program before pursuing such remedies – although the Program is still available to you to resolve the dispute. When utilizing the Program, you will need to provide (a) the vehicle identification number of your vehicle, (b) the identity of your selling and servicing dealerships, (c) the mileage on your vehicle at relevant times, (d) the date and nature of any relevant repairs, (e) legible copies of repair orders and other relevant documents, (f) a summary of the unresolved issue and the requested action, and (g) your contact information. In most cases, the dispute resolution process under the Program will be completed within forty (40) days of your submission of your request and will consist of steps such as an initial eligibility determination, an opportunity for you and us to submit information in writing relating to your claim, an oral hearing, and a decision from the arbitrator. A decision will be binding on you only if you choose to accept it. You may submit a request to NCDS by telephone at their toll free number: (877)-276-8848 or in writing at P.O. Box 463196, Mt. Clemens, MI 48046. You may obtain additional information regarding the Program at www.ncdsusa.org. In the event that the NCDS does not exist or no longer handles disputes for us at the time that you seek to submit a request, you may contact our Customer Assistance Hotline at 1-800-301-6859 to obtain current information about our dispute resolution programs.

GENERAL LIMITATION OF WARRANTY: THIS LIMITED WARRANTY IS IN LIEU OF ALL OTHER EXPRESS WARRANTIES OR LIABILITIES. IN NO EVENT SHALL WE BE LIABLE FOR ANY CONSEQUENTIAL OR INCIDENTAL DAMAGES FOR BREACH OF THIS OR ANY OTHER WARRANTY. SOME STATES DO NOT ALLOW THE EXCLUSIONS OR LIMITATIONS OF INCIDENTAL OR CONSEQUENTIAL DAMAGES, SO THE ABOVE INFORMATION OR EXCLUSION MAY NOT APPLY. NO EXPRESS WARRANTY OF FITNESS OR MERCHANTABILITY IS GRANTED BY THIS LIMITED WARRANTY. THERE ARE NO WARRANTIES WHICH EXTEND BEYOND THOSE DESCRIBED IN THIS DOCUMENT. ANY IMPLIED WARRANTIES, INCLUDING THE IMPLIED WARRANTY OF MERCHANTABILITY OR FITNESS FOR A PARTICULAR PURPOSE, WHICH MAY BE APPLICABLE BY OPERATION OF LAW SHALL BE LIMITED TO THE PERIOD OF THIS WRITTEN LIMITED WARRANTY. SOME STATES DO NOT ALLOW LIMITATIONS ON HOW LONG AN IMPLIED WARRANTY LASTS, SO THE ABOVE LIMITATIONS MAY NOT APPLY. THIS LIMITED WARRANTY PROVIDES SPECIFIC LEGAL RIGHTS, AND THERE MAY BE OTHER RIGHTS WHICH VARY FROM STATE TO STATE. ANY ACTION FOR BREACH OF ANY WARRANTY HEREUNDER, INCLUDING ANY IMPLIED WARRANTY OF MERCHANTABILITY, MUST BE BROUGHT WITHIN A PERIOD NOT EXCEEDING 12 MONTHS AFTER EXPIRATION OF THIS LIMITED WARRANTY. THE REMEDIES SPECIFIED HEREIN AND THOSE SPECIFIED BY APPLICABLE LAW ARE THE ONLY REMEDIES AVAILABLE. WE ASSUME NO OTHER OBLIGATION OR RESPONSIBILITY WITH REGARD TO THE ACCESSORY. WE NEITHER ASSUME, NOR AUTHORIZE ANYONE TO ASSUME FOR US, ANY ADDITIONAL LIABILITY IN CONNECTION HEREWITH.

GENERAL: This limited warranty describes the complete and exclusive rights that result from the purchase of Accessories. No oral representations or statements may be relied upon. This limited warranty may not be amended or modified, and additional rights may not be granted, unless in a written statement signed by one of our officers. This limited warranty shall be governed by the laws of the state where the vehicle is purchased, excluding laws concerning conflicts of law. We may delegate the performance of our duties and obligations and assign our rights and benefits hereunder. For inquiries regarding this limited warranty, we can be contacted directly at **Customer Assistance Hotline at 1-800-301-6859**, or by mail to: **Southeast Toyota Distributors, LLC, Attention: Customer Loyalty Department, 100 Jim Moran Boulevard, Deerfield Beach, Florida 33442.**

Rev. 12/01/16