

TOYOTA
Preparation

TACOMA

2016

Emblem Overlays Matte Black

Part Number: 00016-35072

Accessory Code: JB3300



Conflicts

Note:

Kit Contents

Item #	Quantity Req'd.	Description
1	1	Front Toyota (Sombrero) Emblem Applique
2	2	"TACOMA" Emblem Applique
3	2	"SR5" Emblem Applique
4	2	"LIMITED" Emblem Applique
5	1	"4x4" Emblem Applique
6	1	"V6" Emblem Applique
7	1	Badge Letter "T"
8	1	Badge Letter "A"
9	1	Badge Letter "C"
10	1	Badge Letter "O"
11	1	Badge Letter "M"
12	1	Badge Letter "A"

Recommended Tools

Safety Tools	
Safety Glasses / Gloves	Optional
Special Tools	
Non-Intrusive IR Temperature Probe / Gun	Notes
Installation Tools	
Heat Source	For temperatures under 70°F
Lint-Free Scratch Resistant Cloth	WypAll L40 Disposable Cloth (Recommended)
2" Rubber Roller or Soft Felt Block	
Special Chemicals	
Cleaner	VDC Approved Cleaner (PPO) Alcohol & Water 50 / 50 Mixture (DIO)

Color Applicability/Trim Level

Accessory Color																				
	Vehicle/Trim Color																			

General Applicability







2016 Tacoma SR5 & Limited Edition

Recommended Sequence of Application

Item #	Accessory	

*Mandatory

Legend

-  **STOP:** Damage to the vehicle may occur. Do not proceed until process has been complied with.
-  **OPERATOR SAFETY:** Use caution to avoid risk of injury.
-  **CAUTION:** A process that must be carefully observed in order to reduce the risk of damage to the accessory/vehicle and to ensure a quality installation.
-  **TOOLS & EQUIPMENT:** Used in Figures calls out the specific tools and equipment recommended for this process.
-  **REVISION MARK:** This mark highlights a change in installation with respect to previous issue.
-  **SAFETY TORQUE:** This mark indicates that torque is related to safety.

SPECIAL NOTE: Installation Sequences

After TMS and Safety mandated preparatory steps have been taken, the installation sequence is the suggested method for completing the accessory installation. In some instances the suggested sequence is written for one associate to install and in others the sequence is given as part of a team accessory installation. Unless otherwise stated in the document, the associates may perform the installation steps in any order to make the installation as efficient as possible while maintaining consistent quality.

1) Installation Precautions



- a) Thoroughly clean all installation surfaces. When cleaning with VDC approved cleaner (PPO), follow with a clean water solution.
 - i) Always use a clean WypAll lint-free scratch resistant cloth.
 - ii) Shake VDC cleaner (PPO) or alcohol & water mixture (DIO) well.
- b) Apply VDC cleaner or alcohol mix directly to cloth. Do not spray cleaning solutions directly to vehicle. (Fig.1-1)
- c) Clean surface thoroughly and wipe dry immediately with a new clean cloth. Do not allow VDC cleaner to air dry.
- d) Apply water to a clean cloth. Clean surface thoroughly to ensure any VDC cleaner is completely removed. Wipe dry with a new clean cloth.
- e) Accessory and vehicle installation surface must be between 70°F and 110°F at time of installation.
 - i) A heat source may be used to reach minimum temperature if necessary.

2) Check Kit Content



- a) Inspect kit for content and damage. (Fig. 2-1)

(Fig. 1-1)

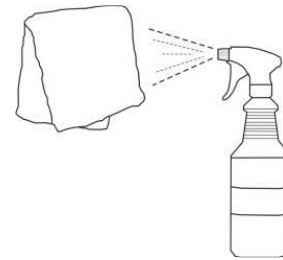

(Fig. 2-1)



Toyota Sombraero Badge Overlay



"Tacoma" Badge Overlay



"LIMITED" Badge Overlay



"Sr5" Badge Overlay



"4x4" Badge Overlay



"V6" Badge Overlay



Tailgate "T A C O M A" Inserts

3) Install Front Toyota Emblem Applique

a) Position part over factory emblem to check for proper fit prior to installation.

 b) Remove adhesive liner by holding the applique edges and pulling the adhesive liner pull tabs. Do not touch adhesive during installation. (Fig. 3-1)

 c) Position applique over factory emblem starting from the top edge then downward, ensuring it is centered. (Fig. 3-2)

d) Once positioned correctly, press firmly on applique starting from the top edge then downward to fully adhere.

 e) Follow with a 2" rubber roller or soft felt block to ensure maximum adhesion contact.

4) Install Side TACOMA Emblem Appliques

a) Position part over factory emblem to check for proper fit prior to installation.

 b) Remove adhesive liner by holding the applique edges and pulling the adhesive liner pull tabs. Do not touch adhesive during installation.

 c) Position applique over factory emblem starting from the top edge then downward, ensuring it is centered. (Fig. 4-1)

d) Once positioned correctly, press firmly on applique starting from the top edge then downward to fully adhere.

 e) Follow with a 2" rubber roller or soft felt block to ensure maximum adhesion contact.

f) Repeat for opposite side TACOMA emblem applique.

(Fig. 3-1)



(Fig. 3-2)

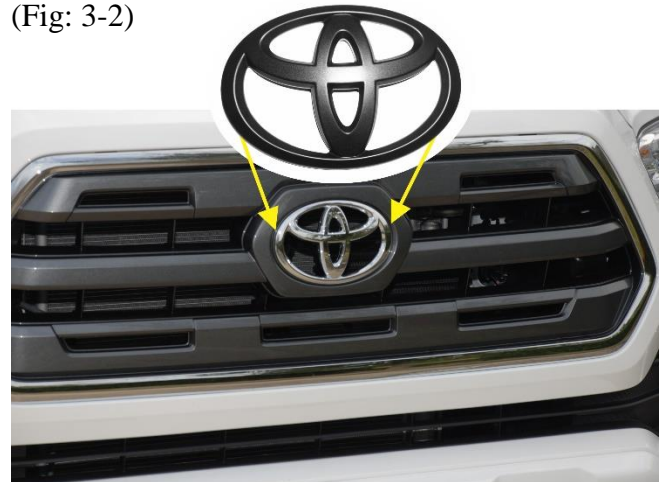

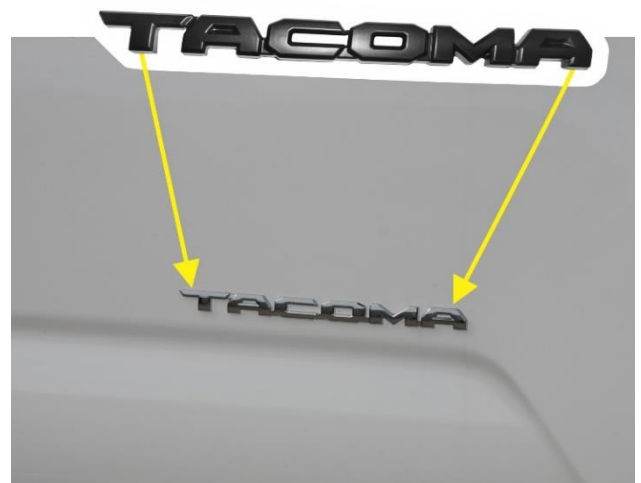

(Fig. 4-1)



5) Install LIMITED or SR5 Emblem Appliques

a) Position part over factory emblem to check for proper fit prior to installation.

 b) Remove adhesive liner by holding the applique edges and pulling the adhesive liner pull tabs. Do not touch adhesive during installation.

 c) Position applique over factory emblem starting from the top edge then downward, ensuring it is centered. (Fig. 5-1, 5-2)

d) Once positioned correctly, press firmly on applique starting from the top edge then downward to fully adhere.

 e) Follow with a 2" rubber roller or soft felt block to ensure maximum adhesion contact.

f) Repeat for opposite side LIMITED or SR5 emblem applique.

6) Install Rear V6 Emblem Appliques

a) Position part over factory emblem to check for proper fit prior to installation.

 b) Remove adhesive liner by holding the applique edges and pulling the adhesive liner pull tabs. Do not touch adhesive during installation.

 c) Position applique over factory emblem starting from the top edge then downward, ensuring it is centered. (Fig. 6-1)

d) Once positioned correctly, press firmly on applique starting from the top edge then downward to fully adhere.

 e) Follow with a 2" rubber roller or soft felt block to ensure maximum adhesion contact.

(Fig: 5-1)



(Fig: 5-2)

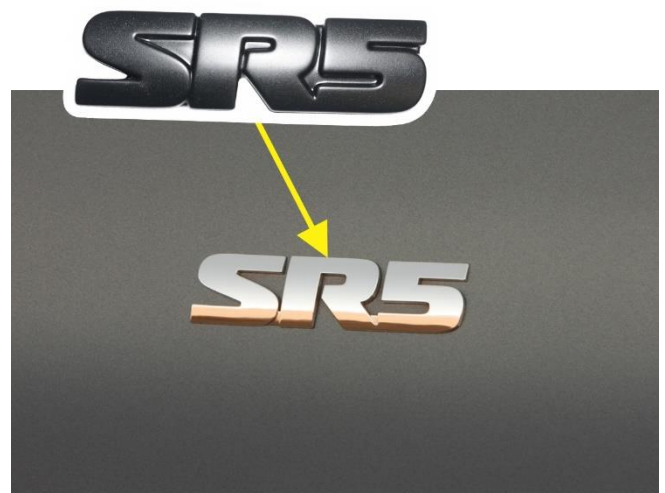



(Fig: 6-1)



7) Install Rear 4x4 Emblem Appliques

a) Position part over factory emblem to check for proper fit prior to installation.

 b) Remove adhesive liner by holding the applique edges and pulling the adhesive liner pull tabs. Do not touch adhesive during installation.

 c) Position applique over factory emblem starting from the top edge then downward, ensuring it is centered. (Fig. 7-1)

 d) Once positioned correctly, press firmly on applique starting from the top edge then downward to fully adhere.

e) Follow with a 2" rubber roller or soft felt block to ensure maximum adhesion contact.

8) Discard all Emblem Appliques that do not apply to the model vehicle. (Fig. 8-1)

(Fig: 7-1)



(Fig: 8-1)



9) Install Tailgate Insert Letter “T”

- a) Center the letter T inside of the corresponding cavity in the rear tailgate to confirm fit. (Fig. 9-1)
- b) Remove adhesive liner from letter. Do not touch adhesive during installation. (Fig. 9-2)
- c) Carefully center the letter T uniformly to edges; gently place letter onto tailgate.
- d) Visually verify that the letter T is positioned evenly into the tailgate cavity.
- e) Once positioned correctly, press firmly on letter T from the center outward toward edges to ensure maximum adhesion contact. (Fig. 9-3)
- f) Follow by pressing firmly with a 2” rubber roller or soft felt block.
- g) Repeat steps for letters A, C, O, M, A.

(Fig. 9-1)

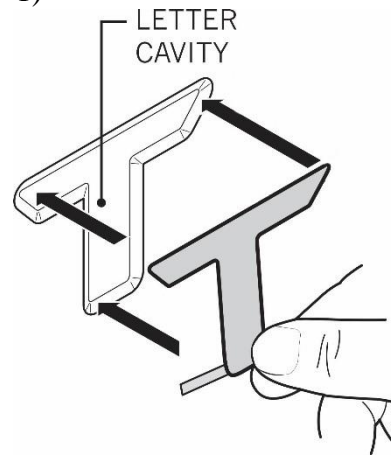

(Fig. 9-2)

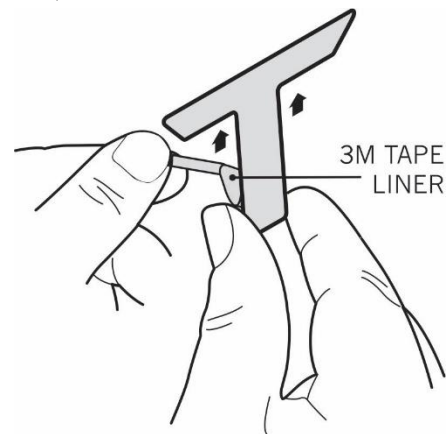

(Fig. 9-3)

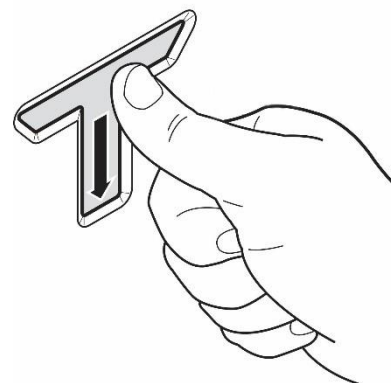

Accessory Function Check:

Applique adhesive

Applique alignment

Tailgate badge adhesive

Tailgate badge alignment

Look For:

Applique should be securely attached to the vehicle.

Applique should be parallel to the edges of the factory emblem and conform to specs provided in installation instructions section. (+/- 1.0mm)

Badge letters should be securely attached to the vehicle; no air pockets or lifting.

Badge letters should be aligned evenly inside of the factory tailgate cavity.