

TOYOTA

TACOMA

2017

LED Fog Light & DRL 2in1

Part Number: 00016-35061

Accessory Code: LD4000



Conflicts

- 1.) Vehicles w/o factory Fog Lights / Manual Transmission
- 2.) TRD Pro Model

Kit Contents

Item #	Quantity Req'd.	Description
1	2	Fog + DRL Housings
2	1	DRL Driver Box
3	1	DRL Harness Bag
4	1	DRL User's Card
5	1	DRL Switch

Hardware Bag Contents

Item #	Quantity Req'd.	Description
1	1	Hood Wire harness
2	1	Cabin Wire harness
3	1	Relay
4	25	Wire ties
5	1	14" wire tie
6	2	Black T-Tap
7		

Additional Items Required For Installation

Item #	Quantity Req'd.	Description

Recommended Tools

Safety Tools	
Safety Glasses	
Electrical Tape	
Installation Tools	
10mm Wrench	
Phillips Screw Driver	
Nylon Pry Tool	
Torque Wrench	48 in-lb
Side Cutters	
Special Chemicals	
3M Silicon Sealant	

Accessory Service Parts

Service Part	DRL + Fog Housing LH	DRL + Fog Housing RH	DRL Switch	DRL Wire Harness	DRL Driver Box	DRL Relay
Part Number						
00016-48011-01	X					
00016-48011-02		X				
00016-35054-01			X			
00016-32270-03				X		
00016-32270-06					X	
00016-32260-04						X

General Applicability

Models: All Automatic Units

Recommended Sequence of Application

Item #	Accessory
1	
2	
3	

Mandatory Legend

STOP: Damage to the vehicle may occur. Do not proceed until process has been complied with.

OPERATOR SAFETY: Use caution to avoid risk of injury.

CAUTION: A process that must be carefully observed in order to reduce the risk of damage to the accessory/vehicle and to ensure a quality installation.

TOOLS & EQUIPMENT: Used in Figures calls out the specific tools and equipment recommended for this process.

REVISION MARK: This mark highlights a change in installation with respect to previous issue.

SAFETY TORQUE: This mark indicates that torque is related to safety.

SPECIAL NOTE:
 After TMS and Safety mandated preparatory steps have been taken, the installation sequence is the suggested method for completing the accessory installation. In some instances the suggested sequence is written for one associate to install and in others the sequence is given as part of a team accessory installation. Unless otherwise stated in the document, the associates may perform the installation steps in any order to make the installation as efficient as possible while maintaining consistent quality. Also some items listed to be removed may not need to be removed if caution is taken to not damage vehicle.

Care must be taken when installing this accessory to ensure damage does not occur to the vehicle. The installation of this accessory should follow approved guidelines to ensure quality installation. These guidelines can be found in the Accessory Installation Practices document.

This document covers such items as:

- Vehicle Protection (use of covers and blankets, cleaning chemicals, etc)
- Safety (eye protection)
- Vehicle Disassembly / Reassembly (panel removal, part storage, etc)

Preparation

 Remove negative battery cable



 Do not touch the positive terminal.

 Wait at least 90 seconds after disconnecting the cable from the negative (-) battery terminal to disable the SRS system.

Installation

1. From front of vehicle, lay the DRL's wire harness on the engine compartment, left side from the battery towards the firewall of the car.

2. Locate the large vehicle harness grommet on the left side. If accessible, cut the auxiliary wiring access nipple off the grommet or cut 1/4" slit in grommet and push the red, black, black-white and red-white wires through firewall. Note: Extra caution should be taken not to damage the connector's pin. Seal with 3M Silicone sealant (pic. 1)



Picture 1

Vehicle Disassembly

3. Remove driver side door scuff plate. Disengage with panel tool and remove (picture 2)

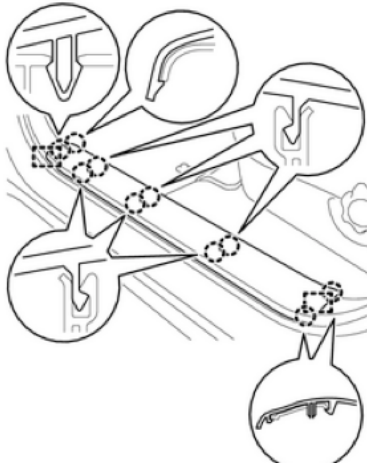

Picture 2

4. Remove the driver side cowl side trim: Remove clip, then disengage cowl plate (pictures 3 and 3A)

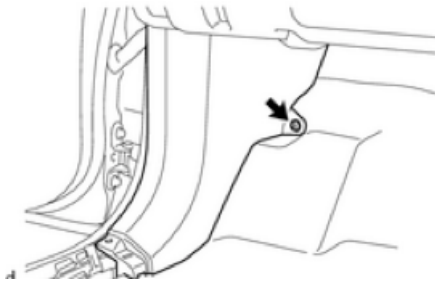

Picture 3

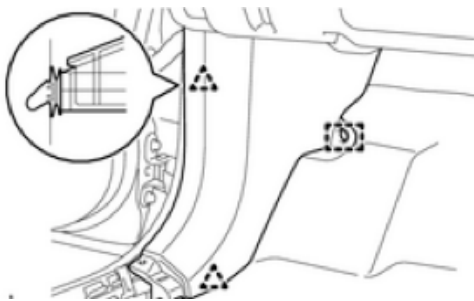

Picture 3A

5. Remove the dash panel on the left side of steering wheel (picture 4).



Picture 4

6. From inside the cabin, locate the wires that were pushed through in step 2. It will be the grommet left of the emergency brake (picture 5).



Picture 5

7. Route the wire harness to reach the left area of the steering wheel
8. Push the pins into the connector supplied in kit. The plastic connects have a mark with a positive (+) and a negative (-) symbol. Push the red wires into the "+" symbol and the black wires into the "-" symbol (picture 6)

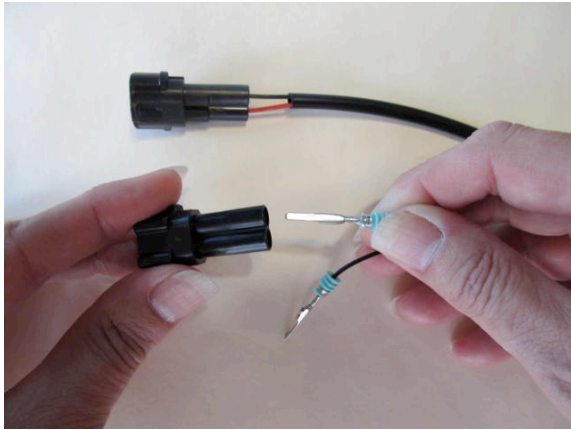

Picture 6

9. Connect the driver box to the wires pushed into the connectors on step 8 (make sure wire colors are aligned: black with black and red with red).
10. Using a 14" wire tie, secure the driver box to next to the steering wheel column (pic. 7).

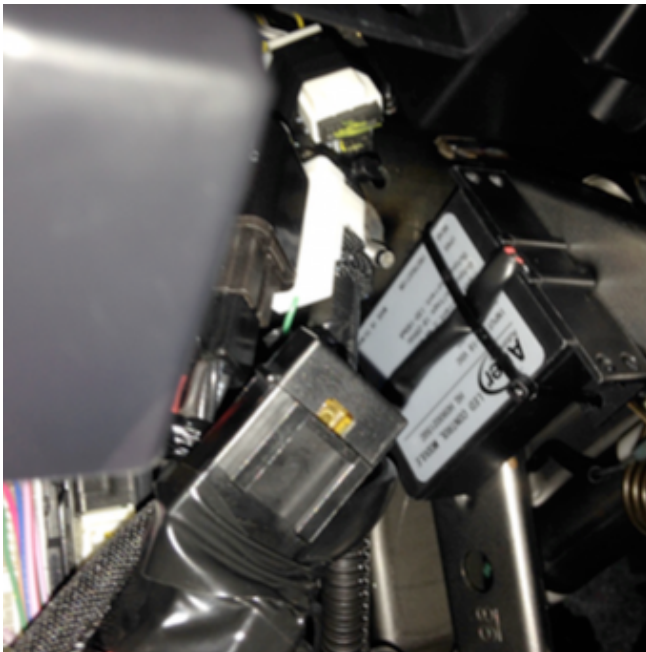

Picture 7

11. Install a BLACK T-tap to connector IC3 pin 8, gray wire. IC3 is located at the kick panel. Then connect the red wire from DRL harness to the t-tap (pictures 8~8C).

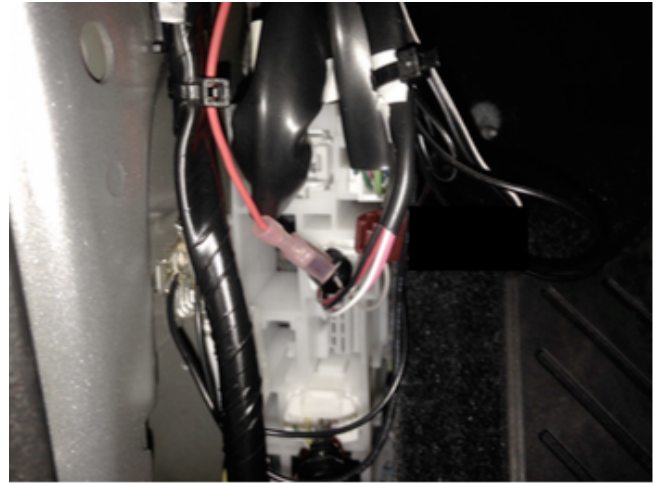

Picture 8: DRL red wire to connector (IC3, pin8)

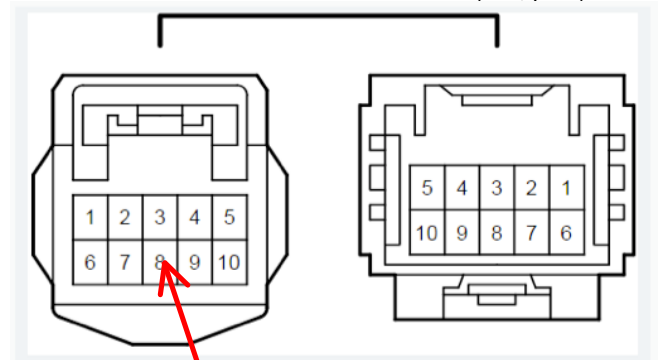

Picture 8A

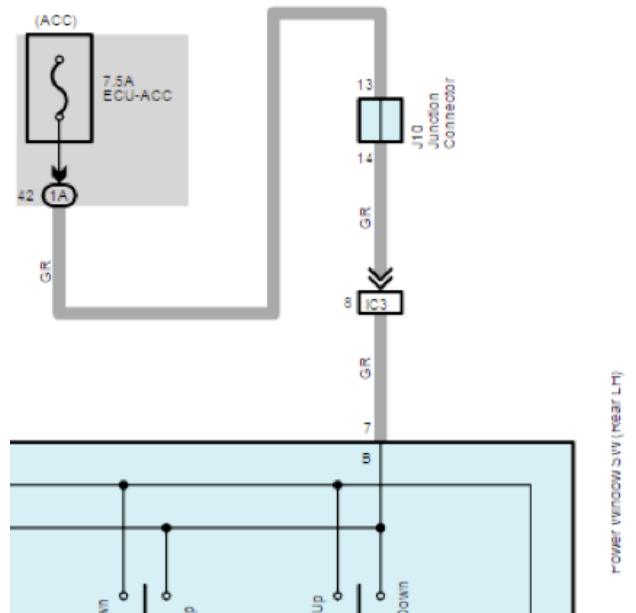

Picture 8B

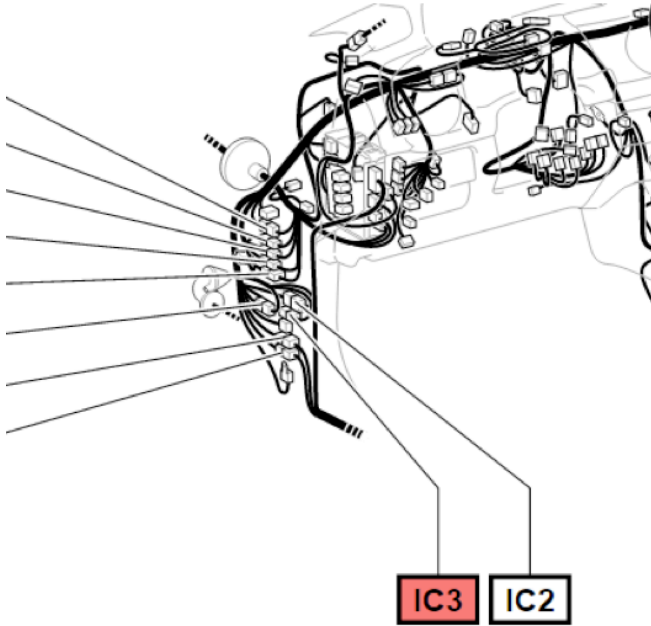

Picture 8B

12. Install a BLACK T-tap to connector D35 pin 1, green wire. D35 is located at the back of the cargo light switch. Then connect the blue wire from DRL harness to the t-tap (pictures 9~9C).



Picture 9: DRL blue wire to connector D35, pin1 (green wire)

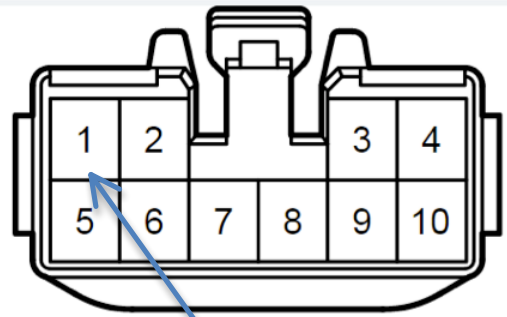

Picture 9A

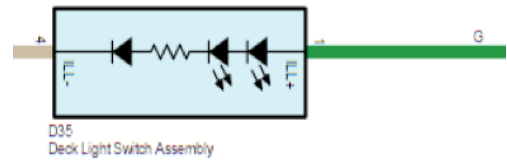

Picture 9B

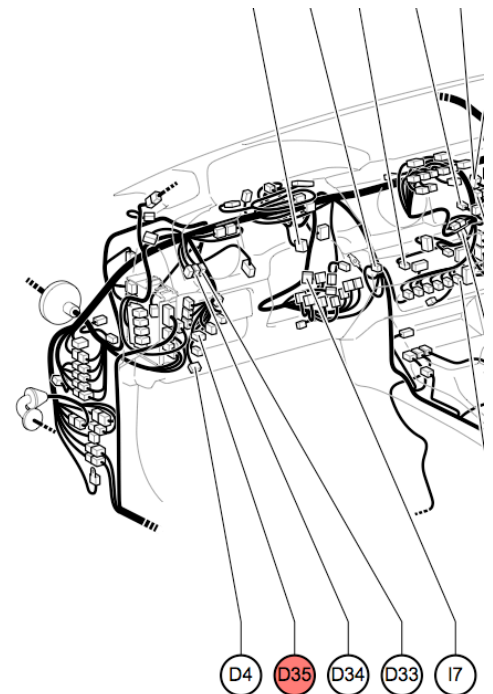

Picture 9C

13. Secure ground (black) wire to bolt by the kick panel (picture 10).

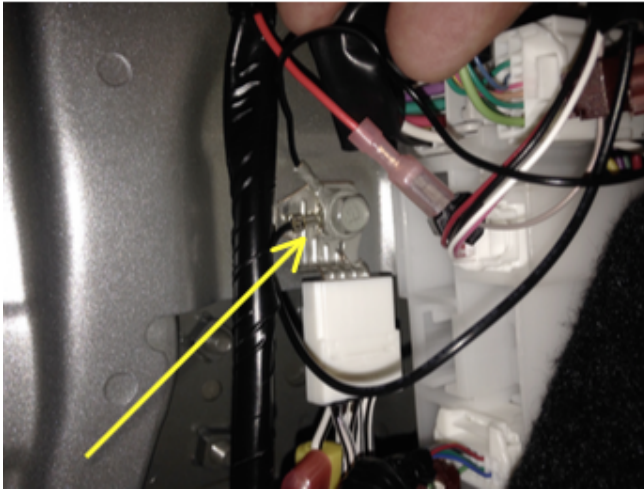

Picture 10

14. Secure relay, fuse and any excess wire from t-taps to factory wire harness, next to driver box (picture 11).



Picture 11

15. Use an empty switch knock out on left panel, (next to the cargo light switch) and mount switch into switch knock out (pics. 12~12A).



Picture 12



Picture 12A

16. Plug DRL harness into switch.
17. Reinstall dash panels and connectors.

ENGINE COMPARTMENT

18. Using wire ties, secure the DRL's wire harness along the driver side of vehicle (pictures 13~13B)



Picture 13

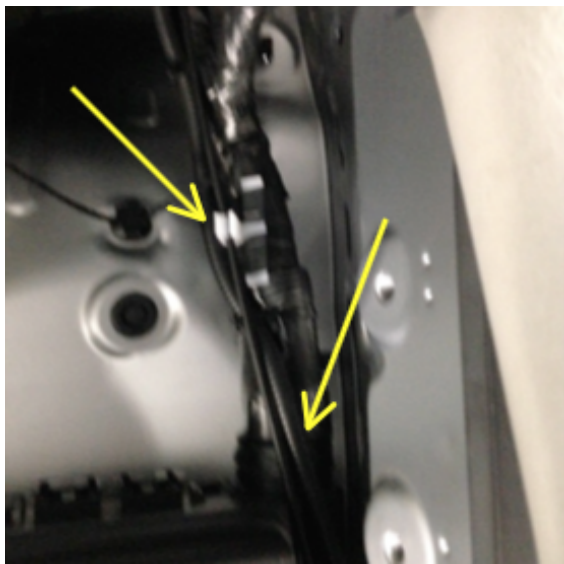

Picture 13A



Picture 13B

- 19. Remove the radiator cover shield (picture 14)

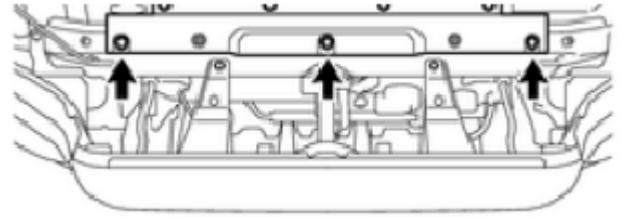

Picture 14



Picture 14A

- 20. Run the wire harness to the right side on top of the radiator housing and secure with 3 wire ties to locations shown in picture 14A. Drop right side of the wire harness to reach behind headlamp compartment area.
- 21. Unplug the driver side factory fog light by accessing from up above the headlamp (picture 15). Then remove the factory fog light: remove Philip screw (do not discard screw, as it will be used to mount 2in1 light).

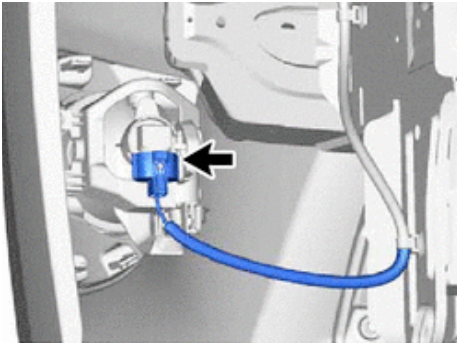

Picture 15

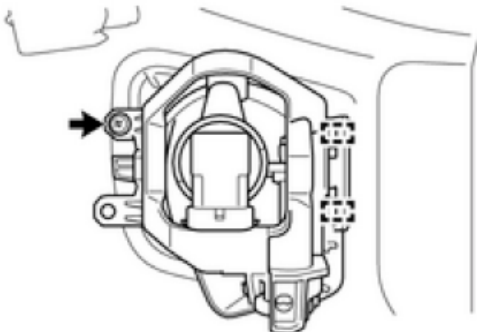

Picture 15A

- 22. Repeat step 19 on passenger side.
- 23. Mount the LH and RH 2 in 1 Lights into bezels.
- 24. At the driver side, take the 2 in 1 light and plug the factory fog light connector into 2 in1 fog light terminal and then connect the DRL harness to the 2 in 1 light DRL terminal (picture 16).



Picture 16

- 25. Repeat process for passenger side.

- 26. Secure excess wires at both sides with wires ties (picture 17).



Picture 17

- 27. Reinstall all panels and radiator grill.
- 28. Reinstall negative battery cable and torque to 48 in-lbs
- 29. From up above the headlamp, adjust fog light aiming by following the procedure below.

Fog Light Aiming

Traditional fog lights are usually mounted in the front bumper about 10-24 inches from the ground. There are two important issues to address when installing fog lights: the first is to minimize the amount of return glare into the drivers eyes, and the other is to minimize the glare into oncoming eyes. Both of these issues must be accomplished while putting as much light as possible on the road.

These fog weather light aiming instructions are suggestions taken from common practice and the S.A.E. standard J583. Some modifications to these instructions may be necessary to minimize glare.

Visual aim is made with the top of the beam 4 inches below the lamp center at 25 feet with the lamp facing straight forward (see picture 18)

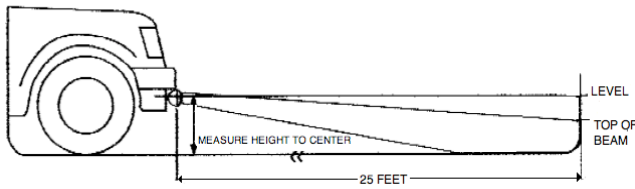

Picture 18

 **NOTE:** Use only hand tools to adjust the fog light aiming screw. DO NOT use automatic tools, as they will damage the fog light

Checklist – these points MUST be checked to ensure quality installation

Check System for Operation

1. DRL will work at full power when ignition switch is ON. DRL will dim out to DOT specifications when lights are ON.
2. If DRL switch position is off, DRL will not work at any time.

Check

Accessory Functions Checks

-
- DRL function.....
 - Fog Lights function.....
 - All Panels snapped into place.....
 - Fog Lights.....
 - Battery Terminal.....
 - Operation Guide.....

Vehicle Function checks

Check functions all switch functions

Look For:

-
-
 -
 - Loose panels and switches
 - Visually confirm lights are straightforward
 - Re-torque battery terminals to 48 in-lb
 - Place DRL operation guide inside glove box.

Block Diagram

LED DRL + LED Fog Light 2in1

Tacoma 2017

Ver. 09.11.2015

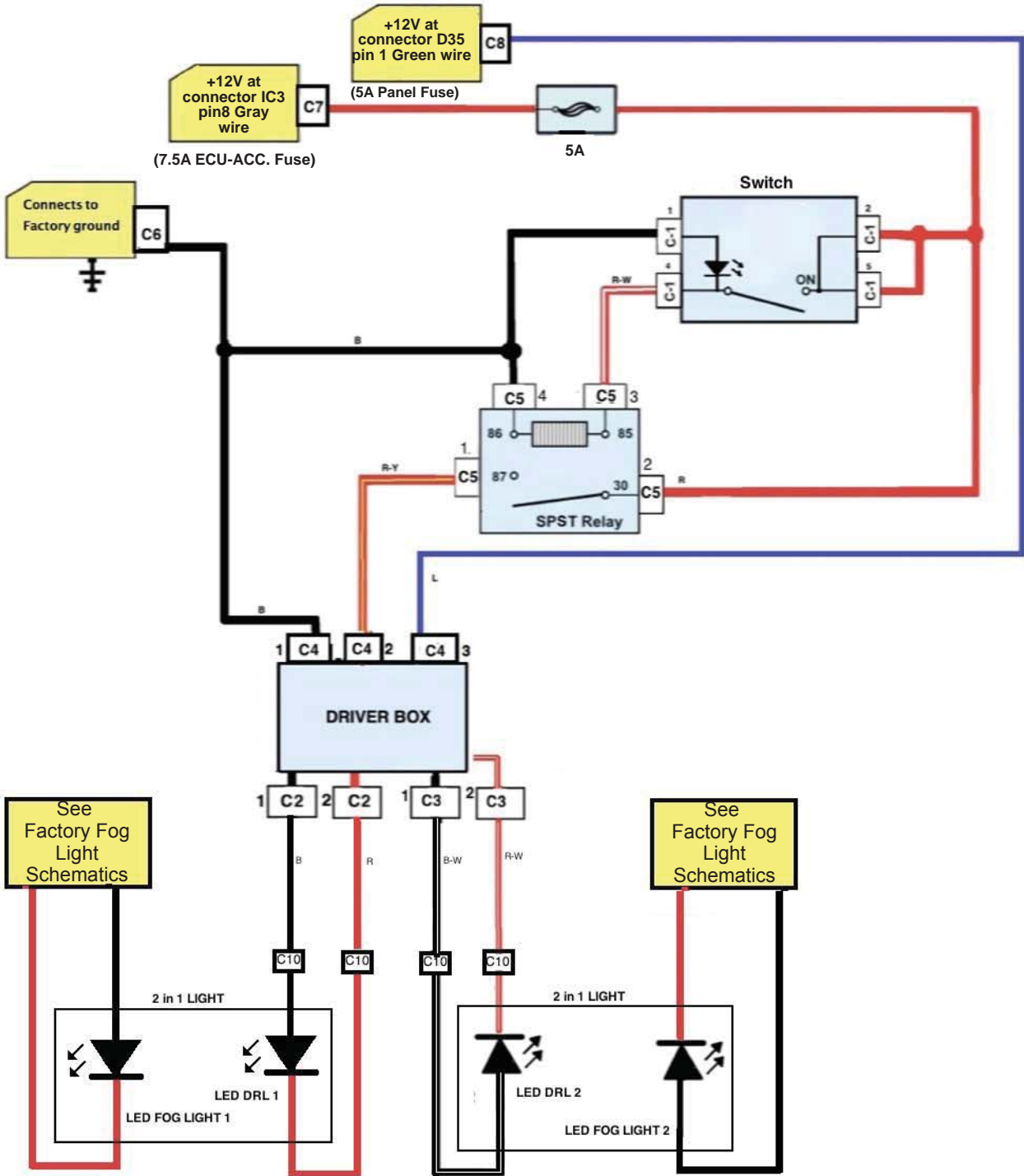

Pinout test

Connector C-1

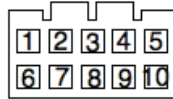

Pin	Wire Color	Test Reference	Proper Operation
1	Black	Pin 1 to Ground	Approximately 0 VDC
2	Red	Pin 2 to Ground	Approximately 0 VDC ignition switch is OFF +12 VDC when ignition switch is ON
4	Red-White	Pin 4 to Ground	Approximately 0 VDC ignition switch is OFF Approximately 0 VDC ignition switch is ON, DRL switch is OFF +12 VDC when ignition switch is ON and DRL switch is ON
5	Red	Pin 5 to Ground	Approximately 0 VDC ignition switch is OFF +12 VDC when ignition switch is ON

Connector C-2, C-3



Pin	Wire Color	Test Reference	Proper Operation
1	Red or Red-White	Pin 1 to Ground	Aproximately 0 VDC when ignition switch is OFF Aproximately 0 VDC when ignition switch is ON, DRL switch is OFF Aproximately +18 to +24 VDC when ignition switch is ON, DRL switch is ON
2	Black or Black-White	Pin 2 to Ground	Aproximately 0 VDC

Connector C-4



Pin	Wire Color	Test Reference	Proper Operation
1	Black	Pin 1 to Ground	Aproximately 0 VDC
2	Red-Yellow	Pin 2 to Ground	Approximately 0 VDC ignition switch is OFF Approximately 0 VDC ignition switch is ON, DRL switch is OFF +12 VDC when ignition switch is ON and DRL switch is ON
3	Blue	Pin 3 to Ground	Aproximately 0 VDC dash panel lights are OFF +12 VDC when dash panel lights are ON

Connector C-5

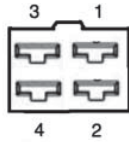

FEMALE TERMINAL VIEW

Pin	Wire Color	Test Reference	Proper Operation
1	Red-Yellow	Pin 1 to Ground	Approximately 0 VDC ignition switch is OFF Approximately 0 VDC ignition switch is ON, DRL switch is OFF +12 VDC when ignition switch is ON and DRL switch is ON
2	Red	Pin 2 to Ground	Approximately 0 VDC ignition switch is OFF +12 VDC when ignition switch is ON
3	Red-White	Pin 3 to Ground	Approximately 0 VDC ignition switch is OFF Approximately 0 VDC ignition switch is ON, DRL switch is OFF +12 VDC when ignition switch is ON and DRL switch is ON
4	Black	Pin 3 to Ground	Aproximately 0 VDC

Connector C-6



Pin	Wire Color	Test Reference	Proper Operation
1	Black	Pin 1 to Ground	Aproximately 0 VDC

Connector C-7



Pin	Wire Color	Test Reference	Proper Operation
1	Red	Pin 1 to Ground	Aproximately 0 VDC when ignition switch is OFF +12 VDC when ignition switch is ON

Connector C-8



Pin	Wire Color	Test Reference	Proper Operation
1	Blue	Pin 1 to Ground	Approximately 0 VDC dash panel lights are OFF +12 VDC when dash panel lights are ON

Connector C-10



Pin	Wire Color	Test Reference	Proper Operation
1	Black	Pin 1 to Ground	Aproximately 0 VDC
2	Red	Pin 2 to Ground	Approximately 0 VDC when ignition switch is OFF Approximately 0 VDC when ignition switch is ON, DRL switch is OFF Approximately +18 to +24 VDC when ignition switch is ON, DRL switch is ON