

**Southeast Toyota Distributors, LLC
Accessory Installation Instructions**

**2019 Tundra
D-Cab Stealth Board**

Year & Model:	2019 Tundra
Part Number:	00016-34134; Chrome 00016-34133; Black
Accessory Code:	RB1100; RB1200
PIO / DIO:	PIO / DIO
Business Partner:	J23

Conflicts

Note: Regular Cab & CrewMax

General Applicability

Fits Models:
Note: Applicable to all 2019 D-Cab Tundra's without factory running board.

Additional Items Required For Installation

Item#	Description:
1.	(1) Wiping cloth, non-scratch
2.	(1) Torque Audit Sheet (PIO, Only)
3.	Note: For PIO Install Using Atlas Copco Torque Management Equipment, See pg. 10

Sequence of Application

Item#	Accessory:
1	N/A

SPECIALNOTE: Installation Sequences
After TMS & Safety mandated preparatory steps have been taken, the installation sequence is the suggested method for completing the accessory installation. In some instances the suggested sequence is written for one associate to install & in others the sequence is given as part of a team accessory installation. Unless otherwise stated in the document, the associates may perform the installation steps in any order to make the installation as efficient as possible while maintaining consistent quality.

Recommended Tool

Safety Items	
Safety Glasses	
Special Tools	
Utility Knife	
Installation Tools	
12mm Deep Socket	Corresponding Drive Tool
13mm Deep Socket	Corresponding Drive Tool
Torque Wrench	18ft. lbs.

Legend

STOP: Damage to the vehicle may occur. Do not proceed until process has been complied with.

OPERATOR SAFETY: Use caution to avoid risk of injury.

CAUTION: A process that must be carefully observed in order to reduce the risk of damage to the accessory/vehicle and to ensure a quality installation.

TOOLS & EQUIPMENT: Used in Figures calls out the specific tools and equipment recommended for this process.

REVISION MARK: This mark highlights a change in installation with respect to previous issue.

SAFETY TORQUE: This mark indicates that torque is related to safety.

Table of Contents

- I. Preparation.....1-5
 - a.) Table of Contents.....2
 - b.) Kit/Hardware Bag Contents.....3
 - c.) Parts for Installation.....4
 - d.) Service & Warranty Information.....5

- II. Procedures
 - a.) Vehicle Pre-Preparation.....6
 - b.) Bracket #1Front Mounting Bracket6
 - c.) Bracket #2-3-4 Mounting Installation.....7
 - d.) Stealth Board Installation.....7-8
 - e.) Clean and Check.....8

- III. Accessory Function Check.....9
- IV. Atlas Copco Torque Procedure.....10
- V. Warranty Statement.....11-12

Kit/Hardware Bag Contents:

Item #	Quantity	Description
1.	2	Front Bracket with Clip (#1)
2.	2	Rear Brackets with Clip (#2)
3.	4	Rear Brackets with Clip (#3-4)
4.	1	Stealth Board (L)
5.	1	Stealth Board (R)
6.	1	Hardware Bag
7.	18	8mm Hex Bolt
8.	18	8mm Lock Washer
9.	18	8mm Flat Washer

Parts for Installation:

Care must be taken when installing this accessory to ensure damage does not occur to the vehicle. The installation of this accessory should follow approved guidelines to ensure a quality installation. These guidelines can be found in the “Accessory Installation Practices” document.

This document covers such items as:

- Vehicle Protection (use of covers and blankets, cleaning chemicals, etc.).
- Safety (eye protection, re-checking torque procedure, etc.).
- Vehicle Disassembly/ Reassembly (panel removal, part storage, etc.).
- Electrical Component Disassembly/Reassembly (battery disconnection, connector removal, etc.).

Item #	Quantity	Description
1.	1	Stealth Board (L) Chrome
2.	1	Stealth Board (R) Chrome
3.	1	Stealth Board (L) Black
4.	1	Stealth Board (R) Black



Example of both Black & Chrome Crew Max Stealth Board

Service & Warranty Information:

Image Key	Parts information		Warranty Information	
	Part Number	Description	Warranty Time	Labor Op. Code
N/A	00016-34133	Tundra D-Cab Black Stealth Boards Kit	N/A	N/A
A	00016-34039-01	Black Step Board - Right	0.5	ATR011
	00016-34039-02	Black Step Board - Left	0.5	ATR011
N/A	00016-34134	Tundra D-Cab Chrome Stealth Boards Kit	N/A	N/A
N/A	00016-34028-01	Chrome Step Board - Right	0.5	ATR011
N/A	00016-34028-02	Chrome Step Board - Left	0.5	ATR011
B	00016-34028-03	Black Step Pad One Side	0.2	ATR031
C	00016-34038-03	Black End Cap One Side	0.2	ATR031
D	00016-34131-01	Bracket & Loc Bolts & Hardware	0.5	ATR021

Note: Combo Code A applicable to ATR011 and ATR021 for additional 0.2 hours when replacing both sides. Combo Code A applicable to ATR031 for additional 0.1 hours when replacing both end caps.

If you are a dealer located outside of the Southeast Region, please contact the SET Accessory Warranty Department at (888) 851-2722 or email Accessory.Warranty@SETToyota.com for claim payment instructions.

Image:

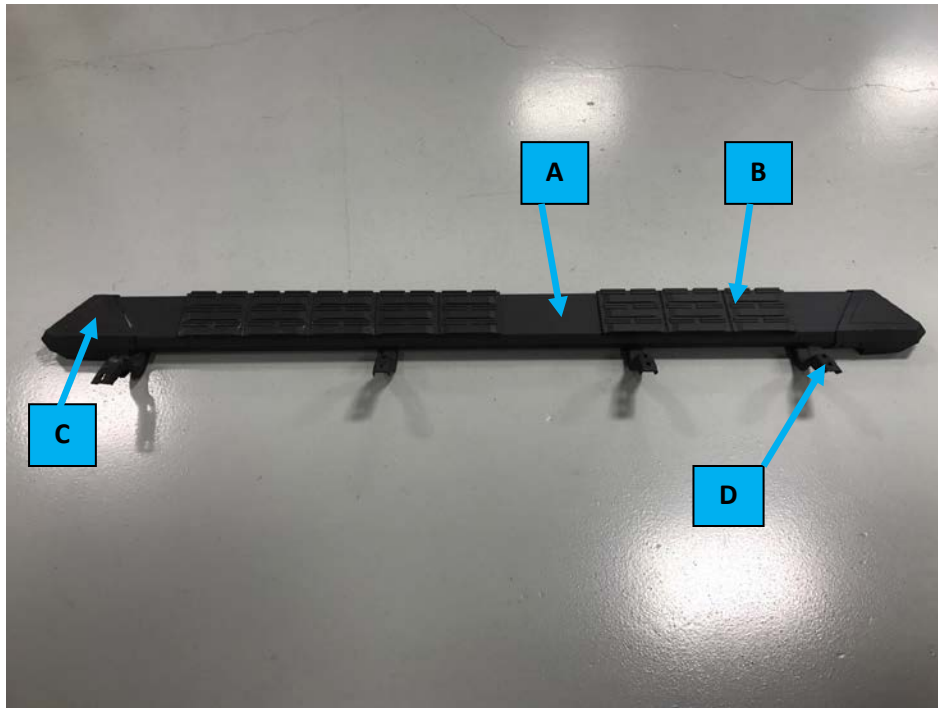

Pre-installation Preparation:

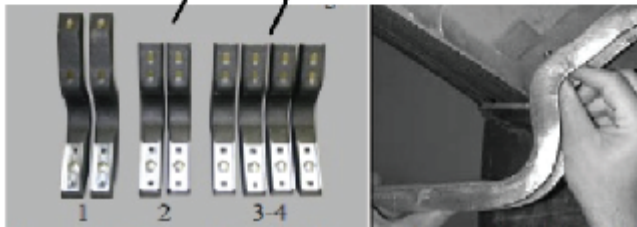
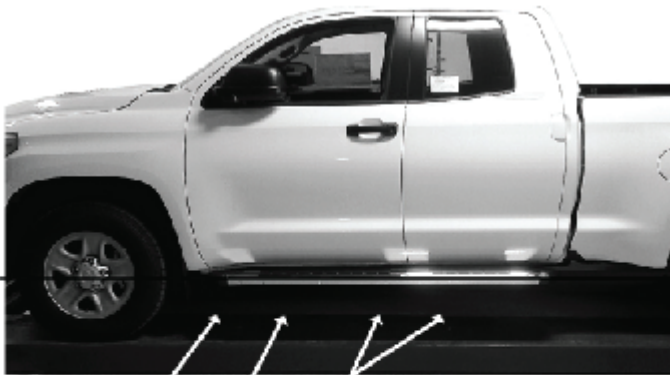



Fig. 1



Fig. 2

Note: All fasteners using sealer or loctite on threads must be checked within five minutes of installation to prevent compromising sealer or loctite. Fasteners using nylon or crimped locking nuts must be checked within five minutes of installation to prevent compromising the nylon or crimp locking mechanism.



1.

-  (a) Remove the protective wrapping from both ends of the Stealth Boards prior to installation.
- (b) Verify Kit and Hardware Bag quality and contents. *** Brackets stamped "2" and "3-4" look similar. Make sure to verify these markings.*

NOTE: Due to the generic nature of the hardware kits, some "extra" hardware may be present. Please save this hardware for future use in case of loss or damage.

-  (c) Wear eye protection.
-  (d) Ensure all application areas are free from any dirt and debris that may damage the surface of the product or vehicle.
-  (e) Using a 12mm socket, remove and discard fourteen (14) OE hex bolts from underneath vehicle.

2 Front Mounting Bracket (#1) Installation

-  (a) The front brackets are longer than the other brackets and can be installed on either side of the vehicle. (Fig. 1)
- (b) Align the front bracket holes to the 8mm threaded factory sidewall holes and install supplied bolts. (Fig. 2)
- (c) Install and snug the bolts, lock washers, and flat washers to the factory-threaded holes (loose enough so the bracket can still slide). (Fig. 3)
-  (d) Do not tighten hardware at this time.

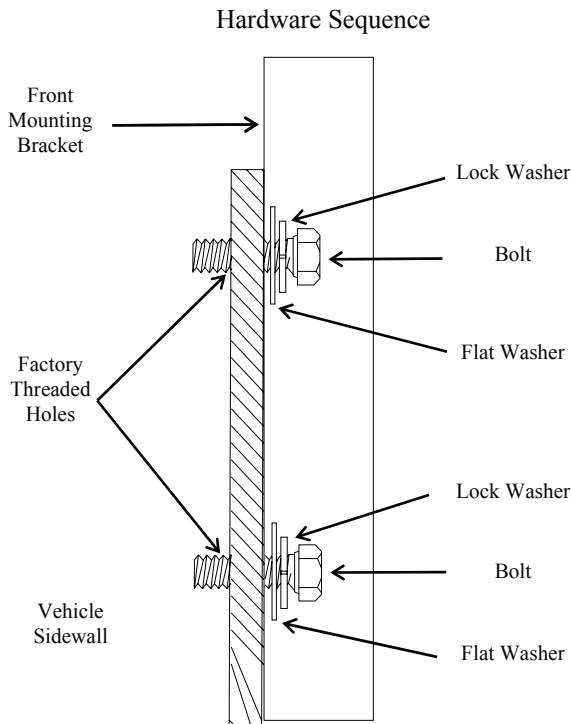

Fig. 3

3. Bracket (#2) Mounting Installation

- ⚠ (a) Brackets (#2) should be mounted behind (#1).
 Brackets (#3-4) are universal and can be installed in either of the 2 rear positions behind (#2).
- (b) Align bracket (#2) holes to the threaded factory sidewall holes and install supplied bolts.
- (c) Install and snug the bolts, lock washers, and flat washers to the factory threaded holes (loose enough so the bracket can still slide). (Figure 4)
- (d) Do not tighten hardware at this time.

4. Bracket (#3-4) Mounting Installation

- ⚠ (a) Align bracket (#3-4) holes to the threaded factory sidewall holes and install supplied bolts.
- (b) Install and snug the bolts, lock washers, and flat washers to the factory threaded holes (loose enough so the bracket can still slide). (Fig. 4)
- (c) Do not tighten hardware at this time.

5. Stealth Board Installation

- ⚠ (a) Lift and rotate the Pinch Clips 90 degrees so that they are perpendicular to the Brackets. (Fig.5)
- (b) Position the appropriate Stealth Board over the Mounting Brackets.
 - (1) Left (Driver Side) Board is marked with an **Orange** sticker.
- (c) Carefully lower the board so that the Pinch Clips rest in the channel in the bottom of the Stealth Board. (Fig.6)
- (d) Lift and rotate the Pinch Clips 90 degrees so they are parallel with the Brackets. (Fig.7)
 - (1) Make sure that the tabs on the Pinch Clip drop into the slots in the Bracket.
 - (2) Make sure all (4) Pinch Clips are correctly engaged to their respective Brackets

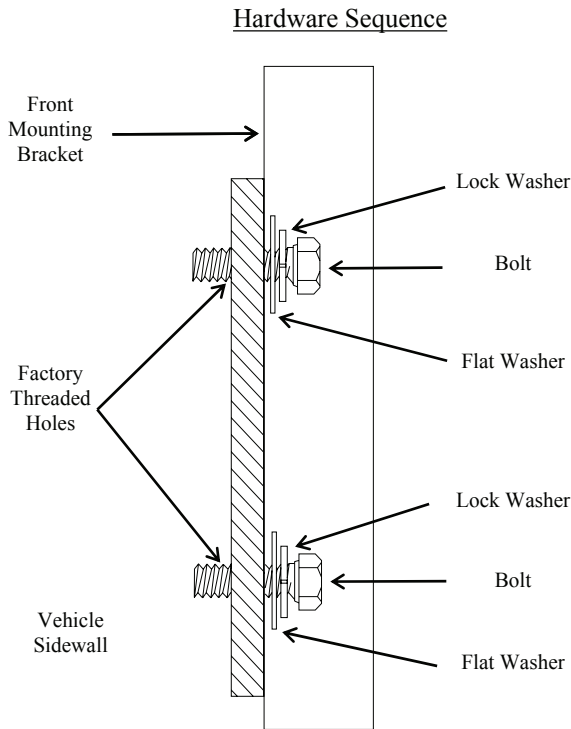

Fig. 4

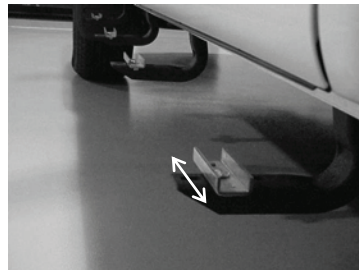

Fig. 5

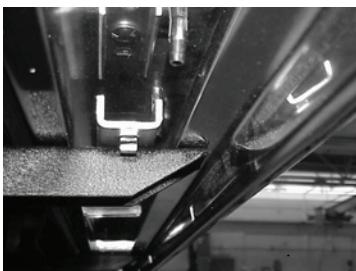

Fig. 6

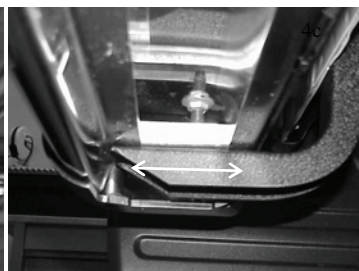

Fig. 7

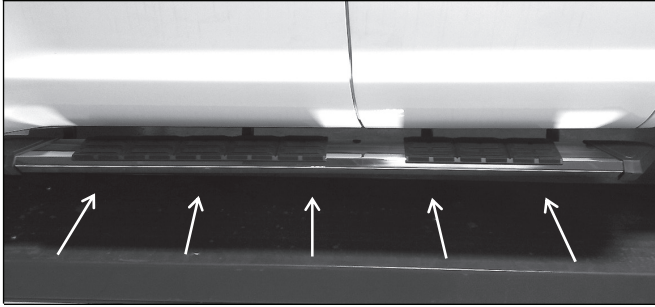

Fig. 8



(e) Position the Stealth Board all the way inboard. (Fig.8)

(f) Tighten the front and rear most bracket to vehicle hardware.

(1) The brackets should mount flush to the vehicle side wall.

(2) Push the bracket assembly up and tighten the bottom bolt first



(3) Make sure the front edge of step board is aligned (+/- 3mm) to the rear edge of front fender.

(g) Tighten the remaining center brackets to step board.

(h) Finally, tighten the remaining center bracket's to vehicle.



(i) Torque the bracket to vehicle hardware to 18 lbs-ft.



(j) Torque the step board to bracket hardware to 18 lbs-ft.

5 Clean and Check



(a) The Stealth Board should not contact any vehicle painted surfaces. If necessary, loosen all bolts, adjust the Brackets as required and re-tighten the bolts to specified torque values. Fig. 9 & 10

(b) Clean any fingerprints or dirt with a damp non-scratch cloth.

(c) Print Warranty Statement and place in glove box, DIO only.

Front

Rear

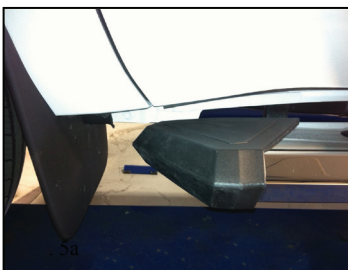

Fig. 9

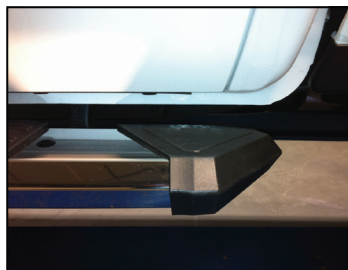

Fig. 10





TOYOTA TUNDRA D-Cab Stealth Board

Checklist - these points **MUST** be checked to ensure a quality installation.

Check:

Look For:

Accessory Function Checks

- | | |
|--|---|
|  Board alignment | Verify board alignment straight and even |
|  Board tightened properly | Torque specifications followed |
|  Torque | Torque the “Bracket to vehicle” 18 ft. lbs.
Inspection range 13.5 ft. lbs ~27 ft. lbs
(-25% / +50%) |
| | Torque the “ Stealth board to bracket” - verify correct torque 18ft .lbs is used during installation. |
|  Warranty Statement | Place Warranty Statement in glove box, DIO Only. |

Note : Range provided by QA

Atlas Copco Torque Prodcedure:



Step Board Torque Procedure

- 1) Loosely install the bolts, and flat washers to the factory- threaded hole.
- 2) Position the Step Board all the way inboard.
- 3) Scan identifiers in the following order. Visually confirm correct entries in controller and flashing red light turns on.
 - a) VIN Number
 - b) Part Number



FIG 1

Note: If an incorrect barcode is scanned, complete the scan procedure then repeat until correct identifiers have been received.

- 4) Use Atlas Copco STB nutrunner shown in FIG 1 to torque fasteners.
- 5) Torque fasteners in order as shown in FIG 2.
- 6) Once job is complete verify on controller.

Chrome Part Number: 00016-34134



Black Part Number: 00016-34133

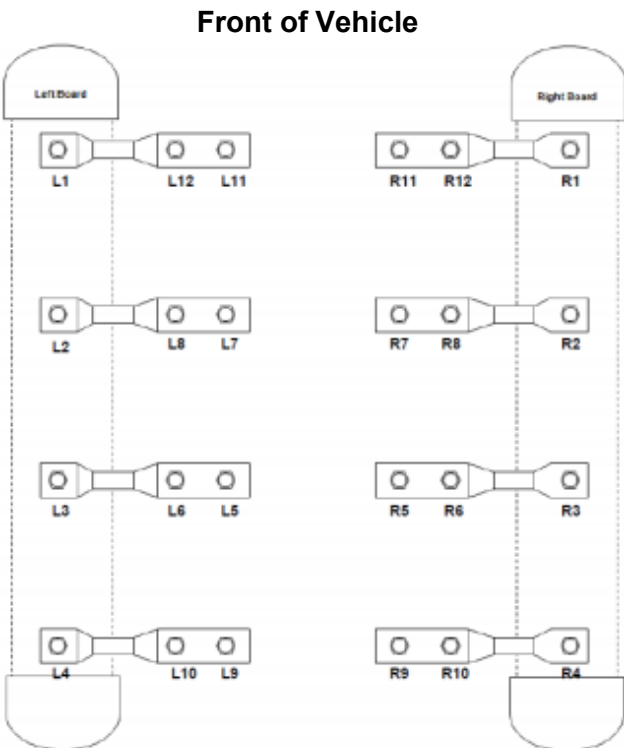

FIG 2

LIMITED WARRANTY – SOUTHEAST TOYOTA

SOUTHEAST TOYOTA DISTRIBUTORS, LLC ("we," "our" and "us") provides the following limited warranty on our accessories, excluding tires, ("Accessories" or "Accessory") installed on a Toyota. This limited warranty is not provided by and does not bind or provide benefit to the vehicle dealer, the manufacturer, or Toyota Motor Sales, U.S.A., Inc. This limited warranty does not apply to tires; please consult the tire manufacturer and/or its materials accompanying the vehicle for any warranty terms concerning tires. This limited warranty also does not apply to ToyoGuard Exterior Paint Sealant and ToyoGuard Interior Protector; please consult the ToyoGuard Limited Warranty Certificate for the warranty terms concerning those products.

SCOPE OF LIMITED WARRANTY:

A. Protection:

- i. **Accessories Installed by Southeast Toyota Distributors, LLC on a new Toyota vehicle.** We warrant that, for a period of 36 months or 36,000 miles, whichever occurs first, we will repair or replace (includes labor), free of charge, any defect in such an Accessory due to faulty material or workmanship, or, at our option, provide a full refund of the purchase price of the Accessory. The warranty period begins on the vehicle's In-Service Date, which is the first date the new vehicle is either delivered to an ultimate purchaser, leased, or used as a company car or demonstrator. Accessories installed by Southeast Toyota Distributors, LLC are identified on the vehicle's window sticker (Monroney Label).
- ii. **Accessories Installed by a Toyota Dealer on a Toyota vehicle.** We warrant that, for 12 months, regardless of mileage, from the date such an Accessory was installed on the vehicle or the remainder of the Toyota new vehicle warranty, whichever is longer, we will repair or replace (includes labor), free of charge, any defect in the Accessory due to faulty material or workmanship, or, at our option, provide a full refund of the purchase price of the Accessory. For a new vehicle, the warranty period begins on the vehicle's In-Service Date, which is the first date the new vehicle is either delivered to an ultimate purchaser, leased, or used as a company car or demonstrator.
- iii. **Accessories purchased from a Toyota Dealer but not installed by the Toyota Dealer.** We warrant that, for a period of 12 months, regardless of mileage, from the date the accessory was purchased, we will repair or replace (does not include labor), free of charge, any defect in the Accessory due to faulty material or workmanship, or, at our option, provide a full refund of the purchase price of the Accessory.

B. Limitation of Warranty. This limited warranty does not apply to, and we will not repair, replace, or reimburse you for: (1) wheel balancing and wheel alignments, except for one wheel balancing or alignment during the first 12 months or 12,000 miles, whichever occurs first, from the vehicle's In-Service Date, as defined above, (2) abrasions or dents, whatever their cause, and any failure or damage resulting directly or indirectly from accidents, collisions, impacts from foreign objects, fire, theft, larceny, explosion, malicious mischief, vandalism, civil commotion, riots, war, or any other similar causes, (3) any failure or damage resulting directly or indirectly from lightning, windstorms, hail, water, floods, subfreezing temperatures, airborne chemicals, tree sap, dust, salt, and any other environmental conditions or similar causes, (4) any failure or damage caused by: (a) a failure of any part, other than the Accessory, (b) any misuse, abuse, improper towing, negligence or lack of maintenance of the vehicle or Accessory, (c) the alteration, modification or repair of the Accessory by anyone other than persons expressly authorized by us to perform such alteration, modification or repair, or (d) the use of the vehicle for commercial purposes, competitive driving or racing, (5) any failure or damage, if the Accessory has not been installed according to instructions, (6) any failure or damage occurring outside of Canada, the United States of America, its territories or possessions, (7) except to the extent required by the state whose laws govern this limited warranty, any consequential, secondary, or unreasonable costs that may be suffered as a result of the need to repair or replace the Accessory, including without limitation any loss of use of the vehicle, road service, towing, storage charges, inconvenience, loss of wages and/or income, additional expense incurred, loss of transportation, rental car expense, or any derivative damage to persons or things other than the Accessory, including other parts of the vehicle, or (8) liability for damage to property or for injury to or death of any person, arising out of the operation, maintenance or use of your vehicle whether or not related to the covered Accessory.

C. Exclusive Remedy. If there is a valid claim under this limited warranty for a defect due to faulty material or workmanship in the Accessory, we will, at our option, either: (i) repair, (ii) replace or (iii) provide a full refund of the purchase price of the Accessory. We have no other obligations under this limited warranty. Refunds will be made to the vehicle owner. If the vehicle is leased, the refund will be made to the leasing company.

HOW TO MAKE A CLAIM: In the event of a warranty claim, please contact the nearest Toyota dealer to arrange for repairs. The dealership must receive our prior authorization before making repairs covered by this limited warranty. The dealer will contact Southeast Toyota Distributors, LLC at 1-888-851-2722, select option #5 (Warranty Department), then option #4 (Repairs), for instructions on processing a warranty claim, if they are not already familiar with the process. If you have any questions or concerns regarding repairs covered by this limited warranty, please contact our Customer Assistance Hotline at 1-800-301-6859.

OUR DISPUTE RESOLUTION PROGRAM: Your satisfaction is our highest priority. In keeping with that focus, in the event that an issue arises related to this Limited Warranty, we invite you to call our Customer Assistance Hotline at 1-800-301-6859 to discuss it. In most cases, we expect that a satisfactory resolution of your issue can be reached through engagement with that Department. If our Customer Loyalty Department is unable to resolve your issue to your satisfaction, we offer a dispute resolution program administered by the National Center for Dispute Settlement (NCDS) ("the Program"). The purpose of the Program is to resolve disputes in an informal setting before an impartial arbitrator. The Program is free of charge to you (although you must bear the cost of any expert witness or attorney you elect to employ). You are required to complete the Program before exercising rights or seeking remedies under the federal Magnuson-Moss Warranty Act, 15 U.S.C. § 2301 et seq. ("the Act"). If you choose to seek remedies that are not created by the Act, you are not required to use the Program before pursuing such remedies – although the Program is still available to you to resolve the dispute. When utilizing the Program, you will need to provide (a) the vehicle identification number of your vehicle, (b) the identity of your selling and servicing dealerships, (c) the mileage on your vehicle at relevant times, (d) the date and nature of any relevant repairs, (e) legible copies of repair orders and other relevant documents, (f) a summary of the unresolved issue and the requested action, and (g) your contact information. In most cases, the dispute resolution process under the Program will be completed within forty (40) days of your submission of your request and will consist of steps such as an initial eligibility determination, an opportunity for you and us to submit information in writing relating to your claim, an oral hearing, and a decision from the arbitrator. A decision will be binding on you only if you choose to accept it. You may submit a request to NCDS by telephone at their toll free number: (877)-276-8848 or in writing at P.O. Box 463196, Mt. Clemens, MI 48046. You may obtain additional information regarding the Program at www.ncdsusa.org. In the event that the NCDS does not exist or no longer handles disputes for us at the time that you seek to submit a request, you may contact our Customer Assistance Hotline at 1-800-301-6859 to obtain current information about our dispute resolution programs.

GENERAL LIMITATION OF WARRANTY: THIS LIMITED WARRANTY IS IN LIEU OF ALL OTHER EXPRESS WARRANTIES OR LIABILITIES. IN NO EVENT SHALL WE BE LIABLE FOR ANY CONSEQUENTIAL OR INCIDENTAL DAMAGES FOR BREACH OF THIS OR ANY OTHER WARRANTY. SOME STATES DO NOT ALLOW THE EXCLUSIONS OR LIMITATIONS OF INCIDENTAL OR CONSEQUENTIAL DAMAGES, SO THE ABOVE INFORMATION OR EXCLUSION MAY NOT APPLY. NO EXPRESS WARRANTY OF FITNESS OR MERCHANTABILITY IS GRANTED BY THIS LIMITED WARRANTY. THERE ARE NO WARRANTIES WHICH EXTEND BEYOND THOSE DESCRIBED IN THIS DOCUMENT. ANY IMPLIED WARRANTIES, INCLUDING THE IMPLIED WARRANTY OF MERCHANTABILITY OR FITNESS FOR A PARTICULAR PURPOSE, WHICH MAY BE APPLICABLE BY OPERATION OF LAW SHALL BE LIMITED TO THE PERIOD OF THIS WRITTEN LIMITED WARRANTY. SOME STATES DO NOT ALLOW LIMITATIONS ON HOW LONG AN IMPLIED WARRANTY LASTS, SO THE ABOVE LIMITATIONS MAY NOT APPLY. THIS LIMITED WARRANTY PROVIDES SPECIFIC LEGAL RIGHTS, AND THERE MAY BE OTHER RIGHTS WHICH VARY FROM STATE TO STATE. ANY ACTION FOR BREACH OF ANY WARRANTY HEREUNDER, INCLUDING ANY IMPLIED WARRANTY OF MERCHANTABILITY, MUST BE BROUGHT WITHIN A PERIOD NOT EXCEEDING 12 MONTHS AFTER EXPIRATION OF THIS LIMITED WARRANTY. THE REMEDIES SPECIFIED HEREIN AND THOSE SPECIFIED BY APPLICABLE LAW ARE THE ONLY REMEDIES AVAILABLE. WE ASSUME NO OTHER OBLIGATION OR RESPONSIBILITY WITH REGARD TO THE ACCESSORY. WE NEITHER ASSUME, NOR AUTHORIZE ANYONE TO ASSUME FOR US, ANY ADDITIONAL LIABILITY IN CONNECTION HEREWITH.

GENERAL: This limited warranty describes the complete and exclusive rights that result from the purchase of Accessories. No oral representations or statements may be relied upon. This limited warranty may not be amended or modified, and additional rights may not be granted, unless in a written statement signed by one of our officers. This limited warranty shall be governed by the laws of the state where the vehicle is purchased, excluding laws concerning conflicts of law. We may delegate the performance of our duties and obligations and assign our rights and benefits hereunder. For inquiries regarding this limited warranty, we can be contacted directly at **Customer Assistance Hotline at 1-800-301-6859**, or by mail to: **Southeast Toyota Distributors, LLC, Attention: Customer Loyalty Department, 100 Jim Moran Boulevard, Deerfield Beach, Florida 33442.**