

TOYOTA Tundra

2017

D-Cab Stealth Board

Part Number: 00016-34134; Chrome
00016-34133; Black

Code: RB1100; Chrome
RB1200; Black



Conflicts

Regular Cab & CrewMax

Kit Contents

Item #	Quantity Req'd.	Description
1	2	Front Bracket with Clip (#1)
2	2	Rear Brackets with Clip (#2)
3	4	Rear Brackets with Clip (#3-4)
4	1	Stealth Board (L)
5	1	Stealth Board (R)
6	1	Hardware Bag

Hardware Bag Contents

Item #	Quantity Req'd.	Description
1	18	8mm Hex Bolt
2	18	8mm Lock Washer
3	18	8mm Flat Washer

Additional Items Required For Installation

Item #	Quantity Req'd.	Description
1	1	Wiping cloth, non-scratch
2	1	Torque Audit Sheet (PIO, Only)
3		Note: For PIO Install Using Atlas Copco Torque Management Equipment, See Last Page.

Recommended Tools

Personal & Vehicle Protection	Notes
Eye Protection	
Special Tools	Notes
Utility Knife	
Installation Tools	Notes
12mm deep socket	Corresponding drive tool
13mm deep socket	Corresponding drive tool
Torque Wrench	18 lbf-ft
Special Chemicals	Notes

General Applicability

Applicable to all D-Cab Tundra's with out factory running board.
--

Recommended Sequence of Application

Item #	Accessory
1	

*Mandatory

Legend

	STOP: Damage to the vehicle may occur. Do not proceed until process has been complied with.
	OPERATOR SAFETY: Use caution to avoid risk of injury.
	CAUTION: A process that must be carefully observed in order to reduce the risk of damage to the accessory/vehicle and to ensure a quality installation.
	TOOLS & EQUIPMENT: Used in Figures calls out the specific tools and equipment recommended for this process.
	REVISION MARK: This mark highlights a change in installation with respect to previous issue.

SPECIAL NOTE: Installation Sequences

After **TMS** and **Safety** mandated preparatory steps have been taken, the installation sequence is the suggested method for completing the accessory installation. In some instances the suggested sequence is written for one associate to install and in others the sequence is given as part of a team accessory installation. Unless otherwise stated in the document, the associates may perform the installation steps in any order to make the installation as efficient as possible while consistent quality.

Note: All fasteners using sealer or loctite on threads must be checked within five minutes of installation to prevent compromising sealer or loctite. Fasteners using nylon or crimped locking nuts must be checked within five minutes of installation to prevent compromising the nylon or crimp locking mechanism.

Care must be taken when installing this accessory to ensure damage does not occur to the vehicle. The installation of this accessory should follow approved guidelines to ensure a quality installation.

These guidelines can be found in the "Accessory Installation Practices" document.

This document covers such items as:-

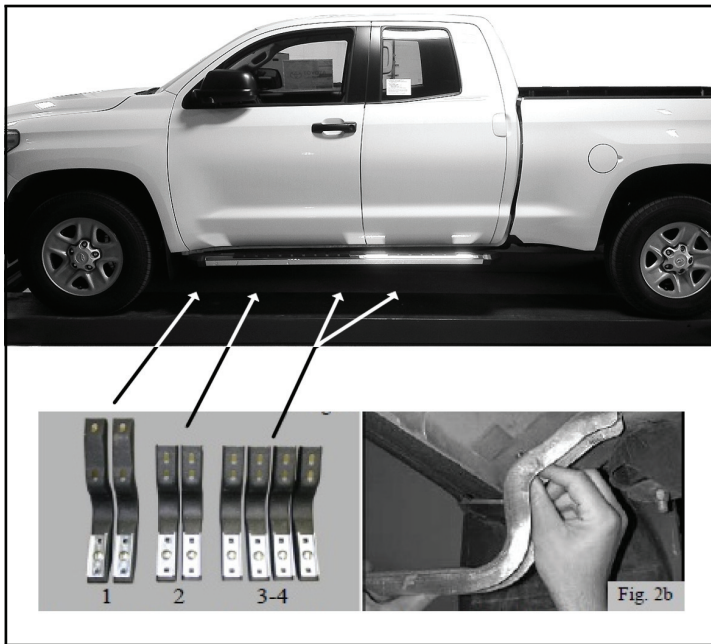

- Vehicle Protection (use of covers and blankets, cleaning chemicals, etc.).
- Safety (eye protection, rechecking torque procedure, etc.).
- Vehicle Disassembly/Reassembly (panel removal, part storage, etc.).
- Electrical Component Disassembly/Reassembly (battery disconnection, connector removal, etc.).





1 Pre-installation Preparation

-  (a) Remove the protective wrapping from both ends of the Stealth Boards prior to installation.
- (b) Verify Kit and Hardware Bag quality and contents. *** Brackets stamped "2" and "3-4" look similar. Make sure to verify these markings.*

NOTE: Due to the generic nature of the hardware kits, some "extra" hardware may be present. Please save this hardware for future use in case of loss or damage.

-  (c) Wear eye protection.
-  (d) Ensure all application areas are free from any dirt and debris that may damage the surface of the product or vehicle.
-  (e) Using a 12mm socket, remove and discard fourteen (14) OE hex bolts from underneath vehicle.

2 Front Mounting Bracket (#1) Installation

-  (a) The front brackets are longer than the other brackets and can be installed on either side of the vehicle. (Fig. 2a - #1)
- (b) Align the front bracket holes to the 8mm threaded factory sidewall holes and install supplied bolts. (Fig. 2b)
- (c) Install and snug the bolts, lock washers, and flat washers to the factory-threaded holes (loose enough so the bracket can still slide). (Fig. 2c)
-  (d) Do not tighten hardware at this time.

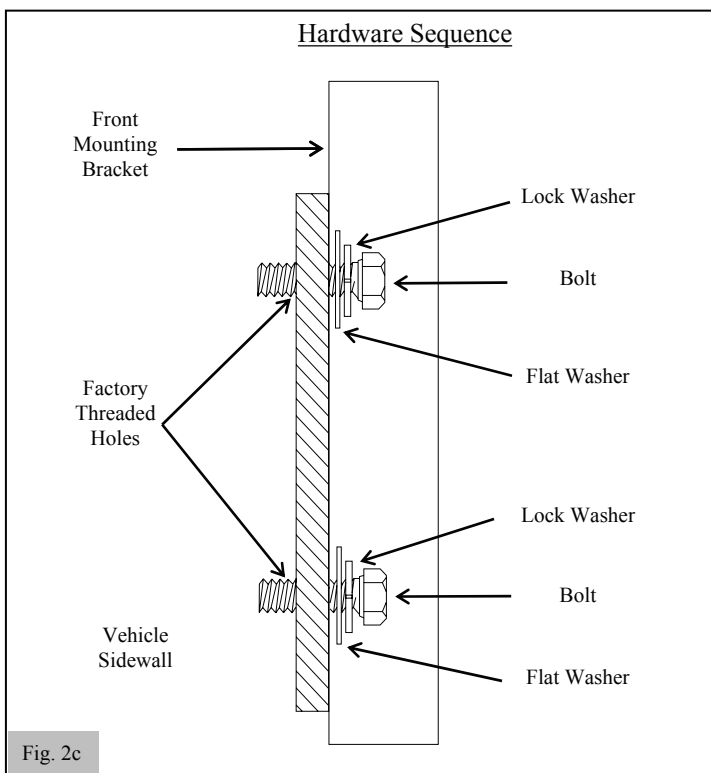

Fig. 2c

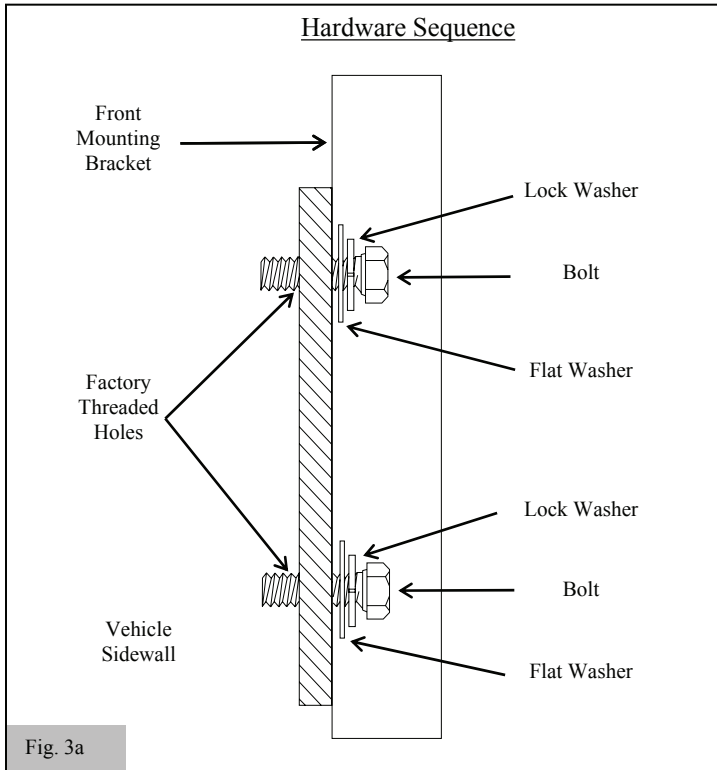

Fig. 3a

3 Bracket (#2) Mounting Installation



- (a) Brackets (#2) should be mounted behind (#1). Brackets (#3-4) are universal and can be installed in either of the 2 rear positions behind (#2).
- (b) Align bracket (#2) holes to the threaded factory sidewall holes and install supplied bolts.
- (c) Install and snug the bolts, lock washers, and flat washers to the factory threaded holes (loose enough so the bracket can still slide). (Figure 3a).
- (d) Do not tighten hardware at this time.

4 Bracket (#3-4) Mounting Installation



- (a) Align bracket (#3-4) holes to the threaded factory sidewall holes and install supplied bolts.
- (b) Install and snug the bolts, lock washers, and flat washers to the factory threaded holes (loose enough so the bracket can still slide). (Figure 3a).
- (c) Do not tighten hardware at this time.

5 Stealth Board Installation



- (a) Lift and rotate the Pinch Clips 90 degrees so that they are perpendicular to the Brackets. (Figure 4a)
- (b) Position the appropriate Stealth Board over the Mounting Brackets.
 - (1) Left (Driver Side) Board is marked with an **Orange** sticker.
- (c) Carefully lower the board so that the Pinch Clips rest in the channel in the bottom of the Stealth Board. (Fig 4b)
- (d) Lift and rotate the Pinch Clips 90 degrees so they are parallel with the Brackets. (Fig 4c)
 - (1) Make sure that the tabs on the Pinch Clip drop into the slots in the Bracket.
 - (2) Make sure all (4) Pinch Clips are correctly engaged to their respective Brackets

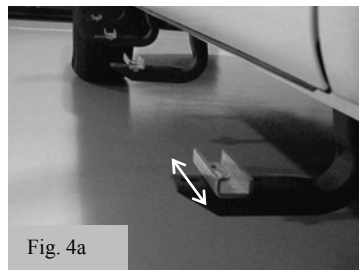

Fig. 4a

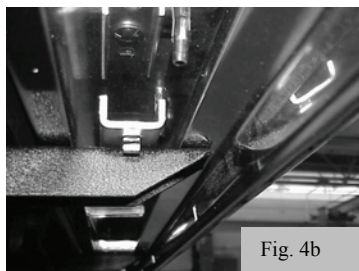

Fig. 4b

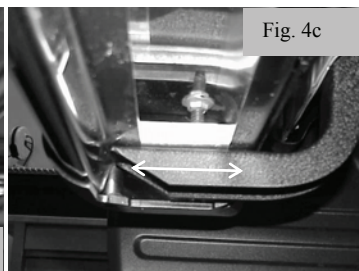
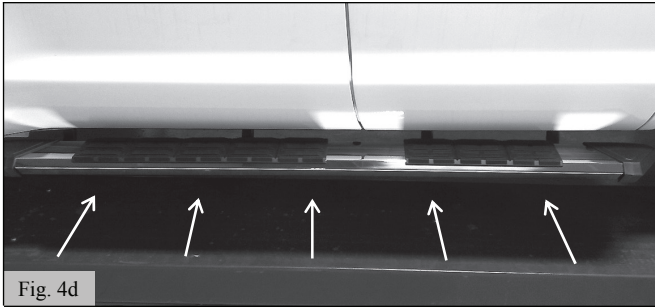

Fig. 4c



- ⚠ (e) Position the Stealth Board all the way inboard. (Fig. 4d)
- (f) Tighten the front and rear most bracket to vehicle hardware.
 - (1) The brackets should mount flush to the vehicle side wall.
 - (2) Push the bracket assembly up and tighten the bottom bolt first
- ⚠ (3) Make sure the front edge of step board is aligned (+/- 3mm) to the rear edge of front fender.
- (g) Tighten the remaining center brackets to step board.
- (h) Finally, tighten the remaining center bracket's to vehicle.
- ⚠ (i) Torque the bracket to vehicle hardware to 18 lbs-ft.
- ⚠ (j) Torque the step board to bracket hardware to 18 lbs-ft.

5 Clean and Check

- ⚠ (a) The Stealth Board should not contact any vehicle painted surfaces. If necessary, loosen all bolts, adjust the Brackets as required and re-tighten the bolts to specified torque values. (Figs. 5a &5b)
- (b) Clean any fingerprints or dirt with a damp non-scratch cloth.

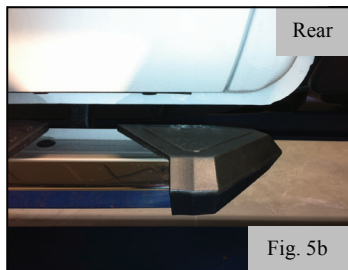
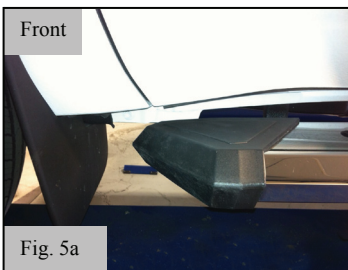

TOYOTA TUNDRA D-Cab Stealth Board

Checklist - these points **MUST** be checked to ensure a quality installation.

Check:

Look For:

Accessory Function Checks

- Board alignment
- Board tightened properly

Torque

Verify board alignment straight and even

Torque specifications followed

Torque the “Bracket to vehicle” 18 ft. lbs.
Inspection range 13.5 ft. lbs ~27 ft. lbs
(-25% / +50%)

Torque the “ Stealth board to bracket” - verify correct torque 18ft .lbs is used during installation.

Note : Range provided by QA



Step Board Torque Procedure

- 1) Loosely install the bolts, and flat washers to the factory- threaded hole.
- 2) Position the Step Board all the way inboard.
- 3) Scan identifiers in the following order. Visually confirm correct entries in controller and flashing red light turns on.
 - a) VIN Number
 - b) Part Number



FIG 1

Note: If an incorrect barcode is scanned, complete the scan procedure then repeat until correct identifiers have been received.

- 4) Use Atlas Copco STB nutrunner shown in FIG 1 to torque fasteners.
- 5) Torque fasteners in order as shown in FIG 2.
- 6) Once job is complete verify on controller.

Chrome Part Number: 00016-34134



Black Part Number: 00016-34133

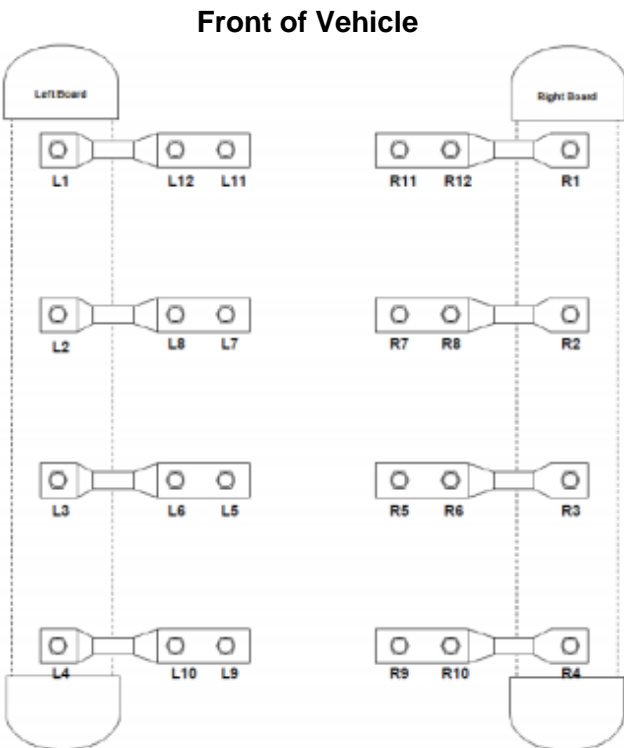

FIG 2