

**Toyota**  
Preparation

**Tundra**

**2015**

**LED Bed Lights**

**Part Number: 00016-34089**

**Accessory Code: BU1000**



**Conflicts**

Note: Drop-in Bed liner

**Kit Contents**

Item #	Quantity Req'd.	Description
1	1	Hardware Kit
2	1	Driver's Side LED assembly
3	1	Passenger Side LED assembly
4	1	Wire-harness

**Hardware Kit Contents**

Item #	Quantity Req'd.	Description
1	4	Philips head stainless steel screws – M4x12mm
2	20	Wire Ties
3	2	22-18 AWG T-Tap (Red)
4	1	12-10 AWG T-Tap (Yellow)
5	2	Connector Body
6	2	Connector Retention Clip

**Recommended Tools**

<b>Safety Tools</b>	
Safety Glasses/Gloves	Required
<b>Special Tools</b>	
PIO Drill Location Template	Driver Side Part #: TUN-34089-DR Passenger Side Part #: TUN-34089-PA
<b>Installation Tools</b>	
Screw Gun/Drill	Assembly installation
7/16" Uni-bit/Drill Bit with Drill Stop (2")	Wire harness routing hole through the bed-wall
1/8" Drill Bit with Drill Stop (2")	Pilot hole for LED retention screws
Ratchet/Socket	10 mm
No. 2 Philips head screw driver	Panel removal / installation
Utility Knife	Grommet access
Pliers	T-tap installation
3M Body Sealant	Grommet sealer
Vacuum	Vacuum Source

**Color Applicability/Trim Level**

Vehicle/Trim Color	Accessory Color																		

**General Applicability**

2015 Tundra

**Recommended Sequence of Application**

Item #	Accessory	
1	Spray Bed Liner	
2	LED Bed Lights	

\*Mandatory

**Legend**

- STOP:** Damage to the vehicle may occur. Do not proceed until process has been complied with.
- OPERATOR SAFETY:** Use caution to avoid risk of injury.
- CAUTION:** A process that must be carefully observed in order to reduce the risk of damage to the accessory/vehicle and to ensure a quality installation.
- TOOLS & EQUIPMENT:** Used in Figures calls out the specific tools and equipment recommended for this process.
- REVISION MARK:** This mark highlights a change in installation with respect to previous issue.
- SAFETY TORQUE:** This mark indicates that torque is related to safety.

**SPECIAL NOTE: Installation Sequences**

After TMS and Safety mandated preparatory steps have been taken, the installation sequence is the suggested method for completing the accessory installation. In some instances the suggested sequence is written for one associate to install and in others the sequence is given as part of a team accessory installation. Unless otherwise stated in the document, the associates may perform the installation steps in any order to make the installation as efficient as possible while maintaining consistent quality.



**1) Vehicle Disassembly**

- a) Remove the negative battery cable.

(Fig. 1-1)



- i) Do not come in contact with the positive terminal during the removal of the negative cable.

(Fig. 1-1)

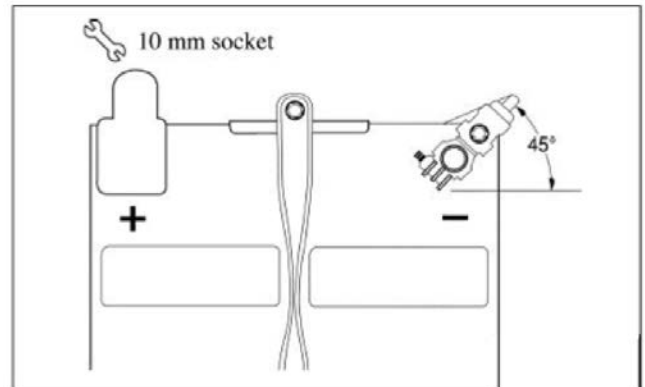

- b) Remove front passenger side door scuff plate. (Fig. 1-2)

- i) Duplicate step on front driver front side.

(Fig. 1-2)



- c) Remove front passenger side kick panel. (Fig. 1-3)

- i) Duplicate step on front driver front side.

(Fig. 1-3)



-  **d)** Remove the dash end cover. (Fig. 1-4)

(Fig. 1-4)

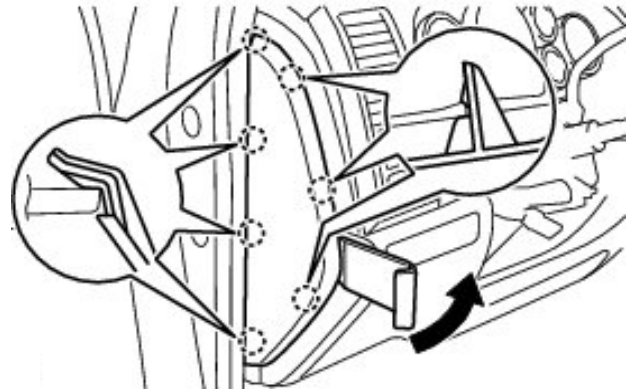

-  **e)** Remove the auxiliary button switch plate.

- i)** Loosen the top left area of the lower instrument panel, by releasing the two clips to the left and right of the top of the auxiliary button switch plate. (Fig. 1-5)

(Fig. 1-5)



- ii)** Remove the auxiliary button switch plate. (Fig. 1-6)
- iii)** Unplug each of the wire connections from the rear of the switch plate.

(Fig. 1-6)





## 2) Bed light LED installation

-  a) Use the plastic templates with reusable tape backing to mark the drill locations for the bed light LED assemblies.(Fig.2-1)

**DIO ONLY:** Cut out the paper templates located on the last two pages of this document by cutting along the dashed lines. After locating the template in step **i** (below), use tape to secure the template as needed. (Fig. 2-2)

- i) Locate off the rear stake bed as illustrated. (Fig. 2-1)

-  ii) Use a 1/8" Drill bit with drill stop set to 2" to pre-drill all 3 holes.
-  iii) Use a 7/16" Drill bit with drill stop set to 2" to drill the center hole for wire harness routing.
- iv) Vacuum drill shavings.

- b) Route the Bed Light LED assembly wire harness through the 7/16" hole.

-  c) Mount the LED assembly using the screws provided. (Fig.2-3)

-  i) Tighten screws: thread to bottom and then one quarter turn. Do Not Over Tighten.

(Fig. 2-1)

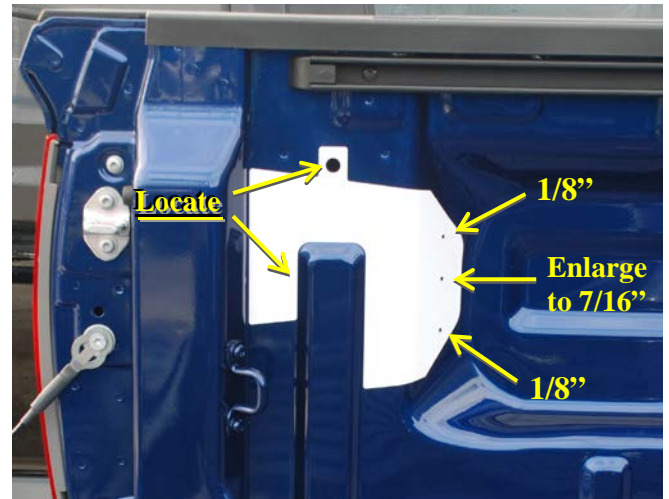

(Fig-2-2)



(Fig. 2-3)

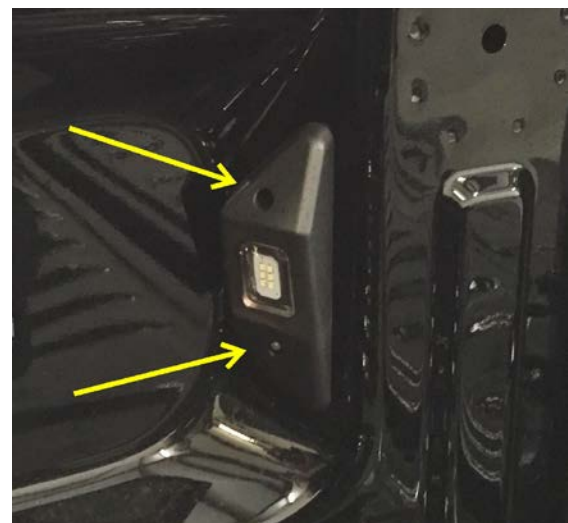

- d) Insert the Bed Light LED assembly harness pins into the connector body and snap on the connector retaining clip. (Fig. 2-4)

- e) Route the Bed Light LED assembly wire harnesses along the factory wire harness toward the passenger side location of the rear of the bed near the spare tire. (Fig. 2-5)

- f) Route the Bed Light LED assembly harness along the factory wire harness on the passenger side, towards the front of the vehicle until you reach the grommet in step 3a. Use wire ties to secure as needed.

**3) Bed Light LED Wire Harness Installation**



- a) Lift the front passenger side Floor carpet to expose the body grommet. (Fig. 3-1)
  - i) Remove the grommet.

(Fig 2-4)

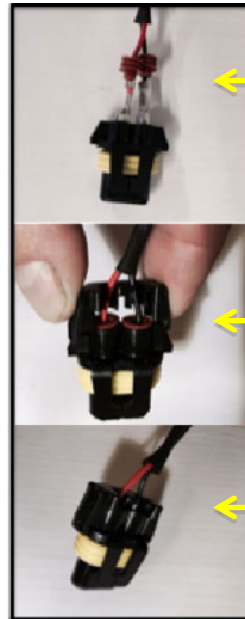

Connector body clip facing up, Red wire LH side // Black wire RH side. Click the pins into the body.

Push the silicon grommets in behind the pins and snap the retaining clip on.

Final assembled body

(Fig. 2-5)

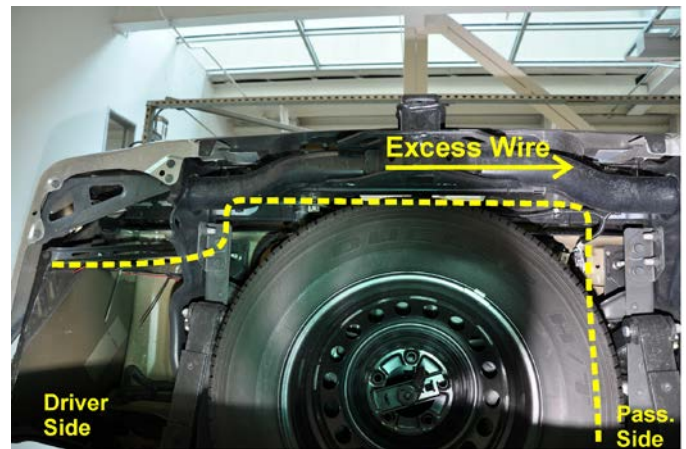

(Fig. 3-1)



- ii) Insert the Bed Light LED wire harness, red blade connector side, through the grommet hole, from the underside of the vehicle. (Fig. 3-2)
- iii) Pull wire harness an adequate length to reach the driver side junction (approx 5-6'), into the passenger compartment.



- iv) Seal the Bed Light LED harness hole in the grommet with 3M Body Sealant.

- b) Route the wire harness from the grommet to underneath the front of the center console.

- i) Lift the passenger side carpet to expose the grommet and foam.
- ii) Run the wire harness from the grommet underneath the foam (as illustrated), then up underneath through the front of the center console and across to the driver side. Do not allow the wire to sit on top of the foam. (Fig. 3-3)

- c) Route the wire harness from underneath the front of the center console to the driver side junction box. (Fig. 3-4)

- i) Lift the driver side carpet to expose the upper portion of the foam.
- ii) Run the wire harness from the center console, down along the top of the foam pad across to the junction box. Do not allow the wire to sit on top of the foam.

(Fig. 3-2)



(Fig. 3-3)



(Fig. 3-4)

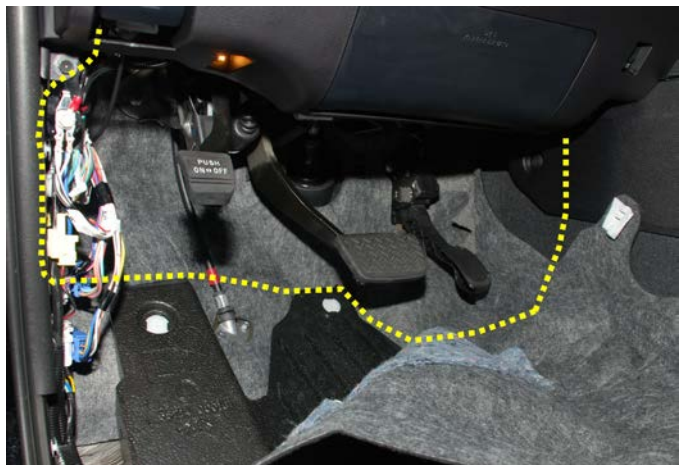

- d) Find the DC connector in the top LH area of the junction block on the LH-side of the steering column. (Fig. 3-5)



- i) Attach a RED T-tap to the PIN 13 BROWN wire. Use pliers to ensure the T-tap is snapped in correctly. (Fig. 3-6 & Fig. 3-7)

- e) Find ground lug bolt located in the driver side kick panel.

(Fig. 3-5)

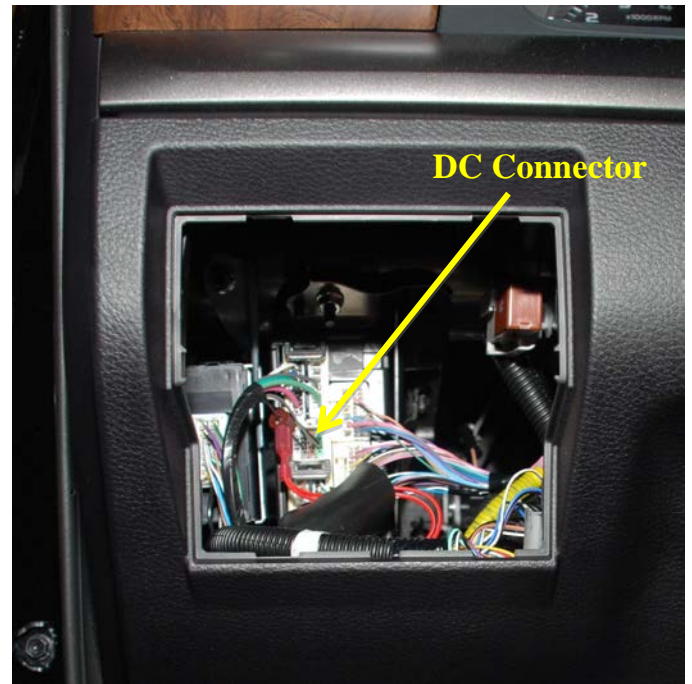

(Fig. 3-6)

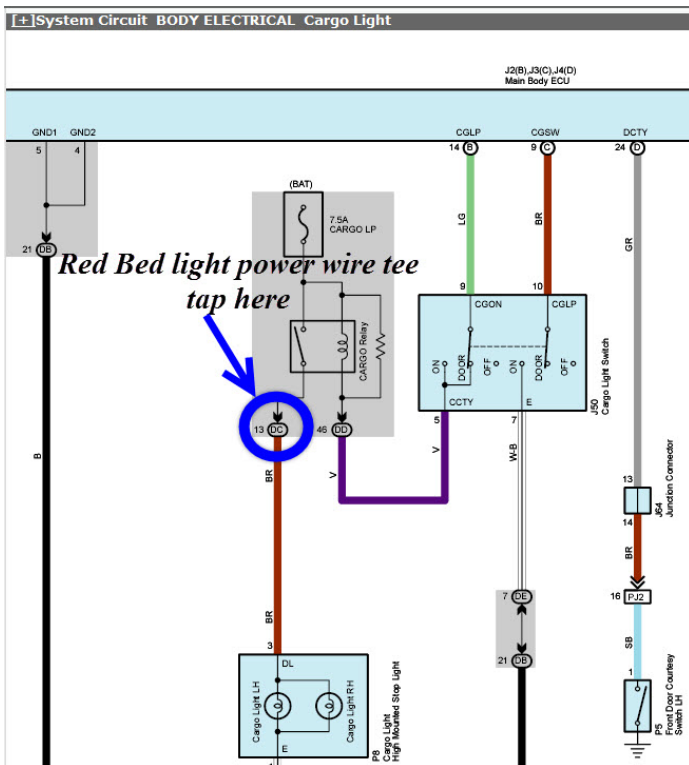

(Fig. 3-7)

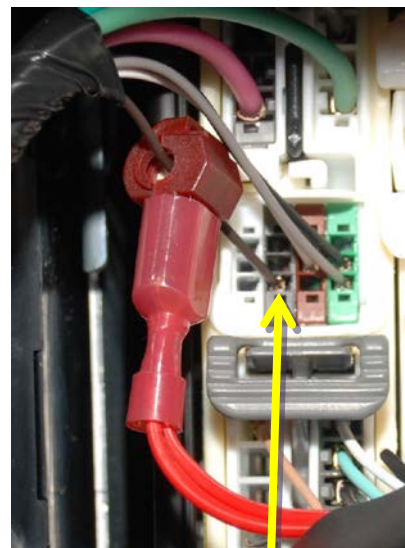

**Brown wire  
Top left connector in  
IB bottom left pin**

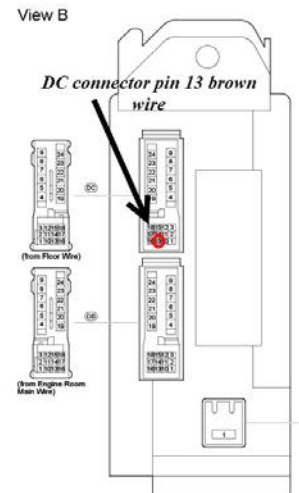



- i) Attach the YELLOW T-tap to the White/black wire. Use pliers to ensure the T-tap is snapped in completely. (Fig. 3-8)
- f) Install the blade connector from the red wire of the bed light LED wire harness onto the RED T-tap.
- g) Install the blade connector from the black wire of the bed light LED wire harness onto the YELLOW T-tap.
- h) Secure bed light LED wire harness to factory wire harnesses using wire ties.

**4) Connect the Bed Light LED Wire Harness**

- a) Connect the Bed Light LED wire harness from the grommet under the passenger side of floor pan of the vehicle to the BED Light LED wire harness coming from the rear of the vehicle along the factory wire harness. (Fig. 3-9)
  - i) Use wire ties to secure the bed light LED wire harness to the factory wire harness.
  - ii) Secure excess wire-harness length onto the vehicles factory wire harness using wire ties as needed. (Fig. 3-10)

(Fig. 3-8)

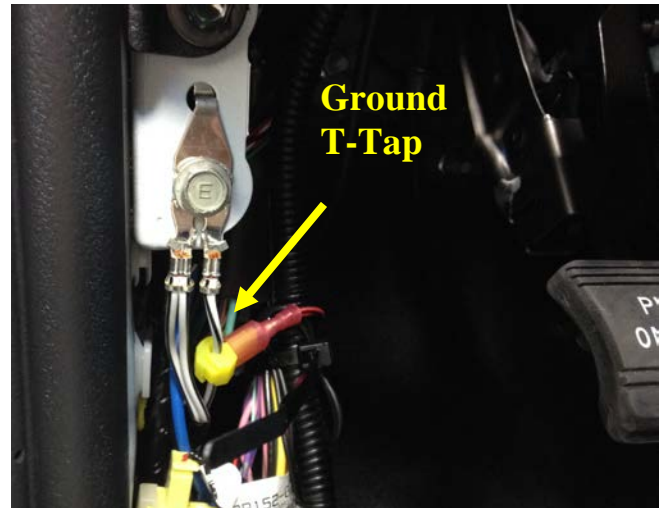

(Fig. 3-9)

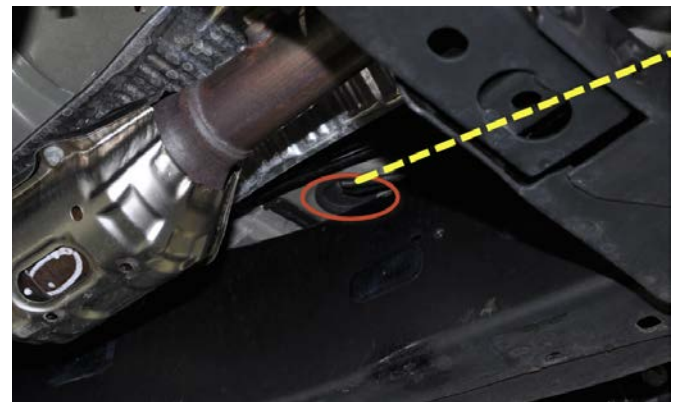

(Fig. 3-10)







**5) Function Check**

- a) Reconnect the vehicle's negative battery cable.
  - i) Position the negative battery cable at the original factory position.
  - ii) Tighten the nut with 48 in lbs of torque.
  - iii) Do not come in contact with the positive terminal during the replacement of the negative cable.
- b) Install the "Short Pin Fuse" and complete the checklist on the right side of this page.



**6) Vehicle Reassembly**

- a) Install the passenger side seat pan grommet.
- b) Trim all excess from wire ties.
- c) Reinstall the driver and passenger side kick panels and foot rest.
- d) Reinstall the driver and passenger side door scuffs.
- e) Reinstall the auxiliary driver switch plate.
- f) Clean up and remove trash.

**Accessory Function Check**

The LED Bed Light should illuminate (Fig. 5-1) with any of the following actions:

- Door is opened
- Cargo light is illuminated
- Key FOB is used to unlock doors



Verify Exterior Cargo Light switch function – all 3 positions.



Verify Interior Dome Light switch function – all 3 positions.



Open the driver side door. The LED Bed Light should be on.



Close the driver side (and passenger) door. Lock the vehicle. The LED Bed Light should turn off.

(Fig. 5-1)



DIO Installation Template Driver Side

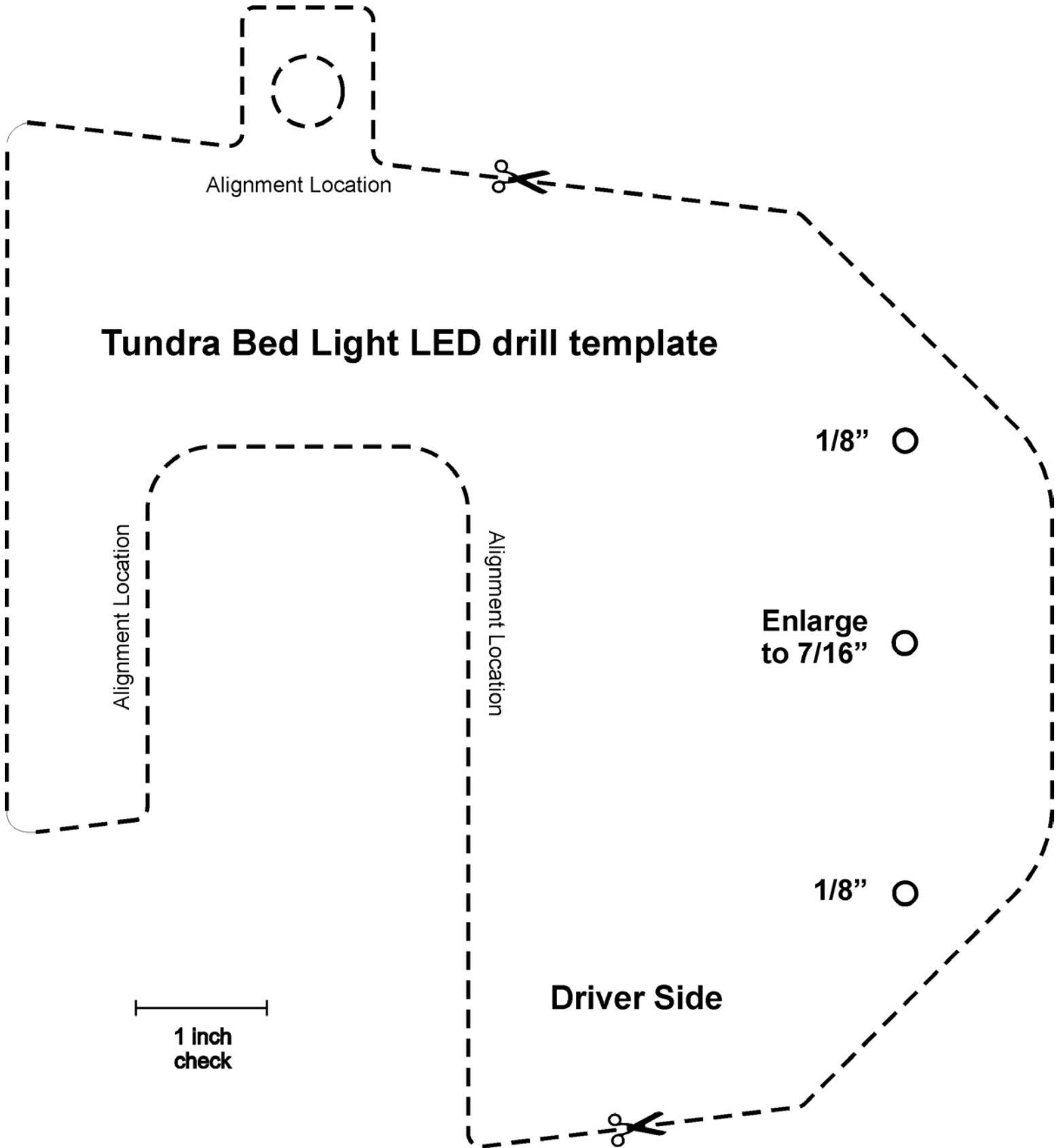

DIO Installation Template Passenger Side

