



Kit Contents

Item #	Quantity Req'd	Description
1	1	Keyless Entry Module
2	2	Keyless Entry Transmitter
3	1	Main Harness - Keyless Entry
4	1	Valet Switch
5	1	Hardware Bag
6	2	24" Black Cable Ties

Hardware Bag Contents

Item #	Quantity Req'd	Description
1	6	Red Tee-Taps
2	2	Blue Tee-Taps
3	1	2-1/4" x 2-1/4" Foam Pad
4	6	8" Black Cable Ties

Additional Items Required For Installation

Item #	Quantity Req'd	Description

Conflicts

Note: **NOT FOR INSTALLATION ON VEHICLES WITH FACTORY KEYLESS ENTRY SYSTEMS.**

Recommended Tools

Safety Tools	
Special Tools	
INSTALLATION TOOLS	
Phillip screwdriver	Straight-Slot screwdriver
Ratchet w/extension	10 mm socket
Diagonal wire cutters	Common pliers
Flashlight	Nylon trim tool
1/4" drill bit	10mm socket
Torque wrench (36 inlbs)	
Special Chemicals	

Color Applicability/Trim Level

Accessory Color	Vehicle Trim Color												
	1	2	3	4	5	6	7	8	9	10	11	12	13

General Applicability

2006 Corolla & 2007 Camry Models with Power Door Locks

Recommended Sequence of Application

Item #	Accessory	

* Mandatory

Legend

STOP: Damage to the vehicle may occur. Do not proceed until process has been complied with.

OPERATOR SAFETY: Use caution to avoid risk of injury.

CRITICAL PROCESS: Proceed with caution to ensure a quality installation. These points will be audited on a completed vehicle installation.

TOOLS & EQUIPMENT: This calls out the specific tools and equipment required for this process.

REVISION MARK: This mark highlights a change in installation with respect to previous issue.

SPECIAL NOTE: Installation Sequences

After **TMS** and **Safety** mandated preparatory steps have been taken, the installation sequence is the suggested method for completing the accessory installation. In some instances the suggested sequence is written for one associate to install and in others the sequence is given as part of a team accessory installation. Unless otherwise stated in the document, the associates may perform the installation steps in any order to make the installation as efficient as possible while maintaining consistent quality.

SERVICE PARTS

ITEM	QUANTITY	PART NUMBER	DESCRIPTION
1.	1	00016 - 79200-01	Main Keyless Entry Control Module
2.	2	00016 - 34030-05	Keyless Entry Transmitter
3.	1	00016 - 32901-01	Main Wiring Harness
4.	1	00016 - 30960-56	ON/Off Toggle Control Switch
5.	1	00016 - 32901-02	Miscellaneous Hardware Kit

INSTALLATION PREPARATION

Before starting installation

1. Familiarize yourself with the installation instructions.
2. Inspect kit components (Refer to kit contents and hardware bag contents).

VEHICLE PREPARATION

1. Place protective coverings on vehicle.



2. **IMPORTANT !**

**Disconnect the Vehicle's
Negative Battery Cable**

3. Refer to the vehicle repair manual, and remove driver's scuff plate, kick panel, lower dash panel and steering column covers to gain access to JB #1, the Driver's Side Kick Panel, and the Ignition Switch Connectors.

4. Remove the (3) 10 mm nuts securing the driver's side JB. Lowering the JB will ease in making connections on the side of the JB.

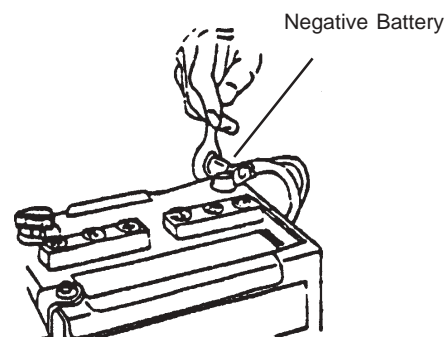

INSTALLING THE KEYLESS ENTRY SYSTEM

MOUNTING THE KEYLESS ENTRY MODULE

1. Secure the main module to the harness above and behind the driver side JB using the long cable ties and adhesive pad provided in the hardware bag.

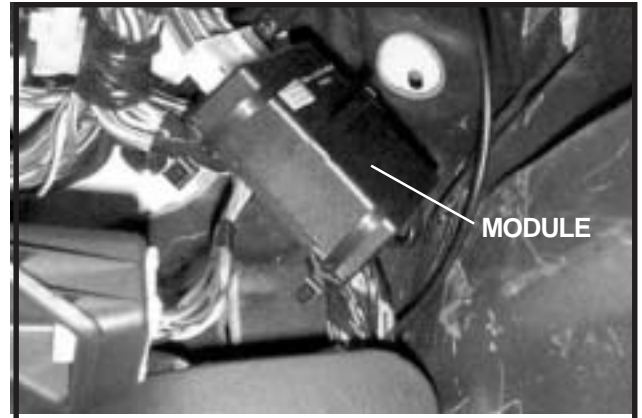

ROUTING THE MAIN HARNESS

1. Route the portion of the harness which includes the Brown, Brown w/ White, and Blue w/ White wires to the driver's side JB. Route the 6 pin ignition connectors over the steering column to the ignition switch.

2. Secure the main harness along it's routing with the cable ties provided. Be sure that the harness is clear of all sharp and moving objects.



IMPORTANT ! Make sure that the brake pedal, accelerator pedal, and accelerator pedal linkages are free and clear of all keyless entry harnesses.

MOUNTING THE TOGGLE SWITCH



1. Carefully drill a 1/4" hole at the location indicated. Install the switch into the kick panel from the backside. Install the **ON/OFF** bezel and nut. Tighten nut using care not to over torque the switch.

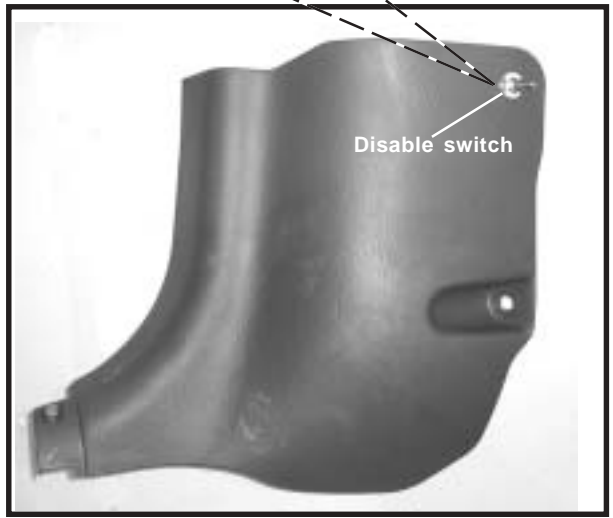

CONNECTING THE MAIN HARNESS

1. Carefully follow the wiring diagram and factory connector details found on the following two pages.
2. Refer to page 10 after completion of harness connections.

WIRING DIAGRAM

NOTE: In some production, the factory is using a Green w/ Yellow Stripe wire for the horn circuit. It is important to be sure the connection is made at location number 1 of connector C10, as this will ensure the connection is made to the horn circuit.

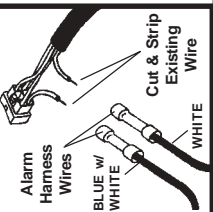
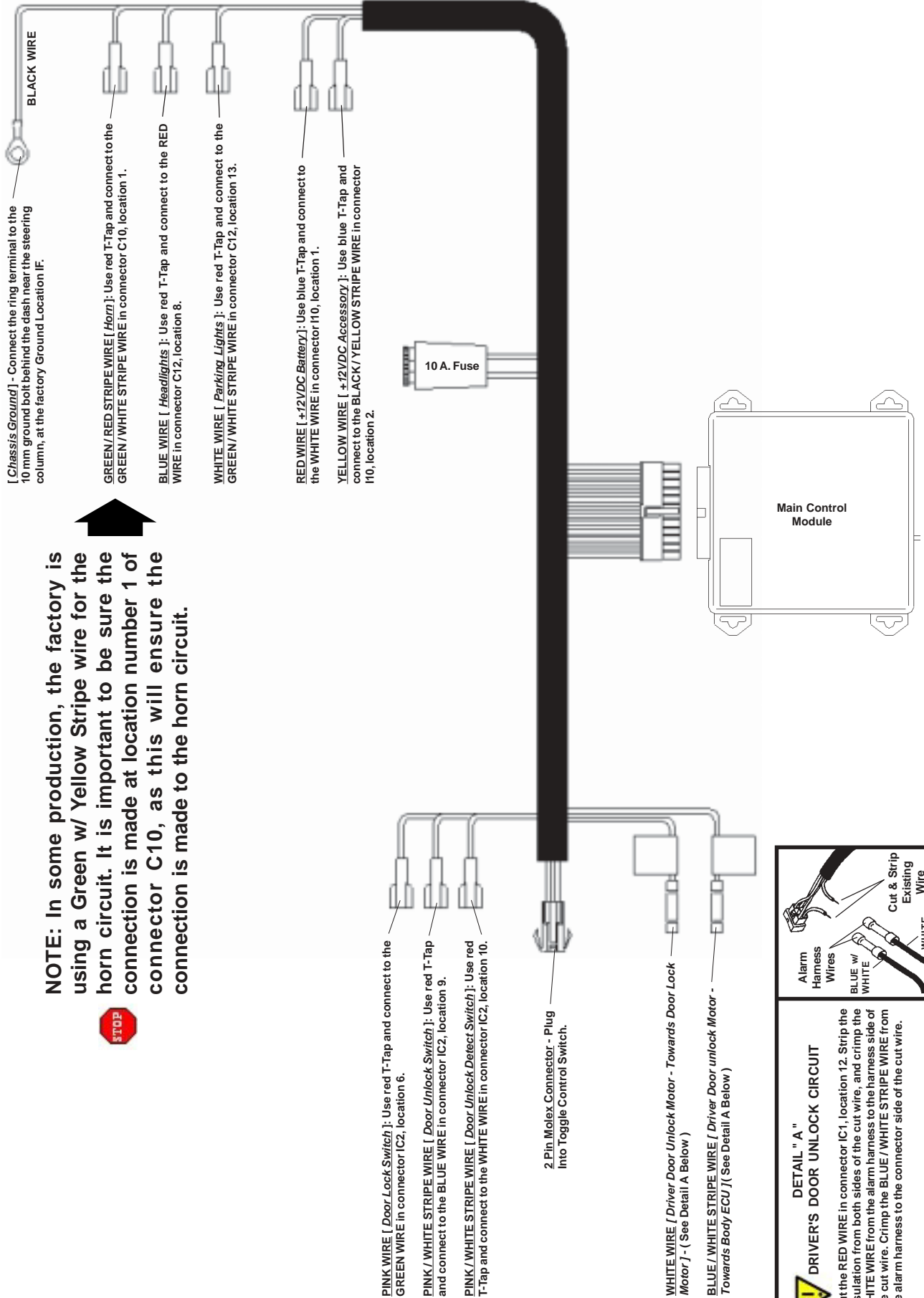

DETAIL "A"
DRIVER'S DOOR UNLOCK CIRCUIT

Cut the RED WIRE in connector IC1, location 12. Strip the insulation from both sides of the cut wire, and crimp the WHITE WIRE from the alarm harness to the harness side of the cut wire. Crimp the BLUE/WHITE STRIPE WIRE from the alarm harness to the connector side of the cut wire.

CONNECTOR DETAILS - 2006 Corolla Keyless Entry

1. CONNECTOR I10: Ignition Switch

Location : At Back Of Ignition Switch, behind lower Steering Column Cover Panel.

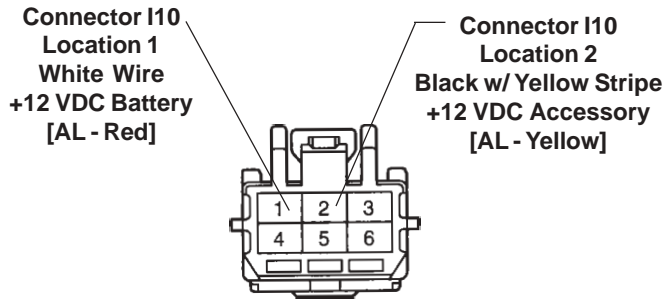

2. CONNECTOR C10 : Horn

Location : Top of Steering Column, at Spiral Cable.

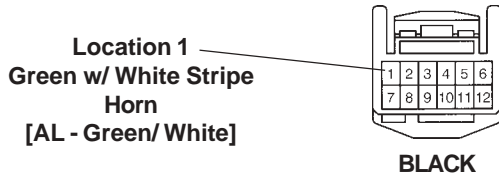

NOTE: In some production, the factory is using a Green w/ Yellow Stripe wire for the horn circuit. It is important to be sure the connection is made at location number 1 of connector C10, as this will ensure the connection is made to the horn circuit.

3. CONNECTOR C12 : Comb. Switch

Location : Top of Steering Column, at Headlight Switch.

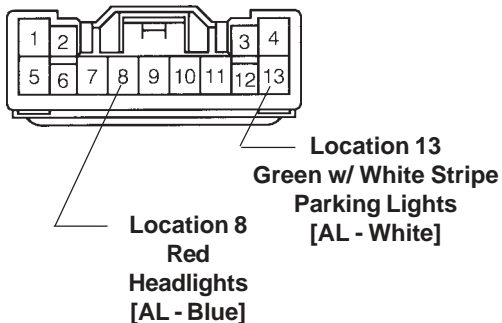

4. CONNECTOR IC1 : Door Lock

Location : Driver's Kick Panel.

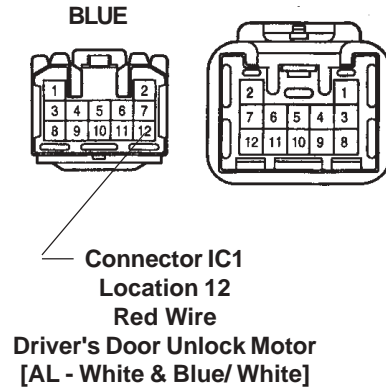

5. CONNECTOR IC2 : Door Key Sw.

Location : Driver's Kick Panel.

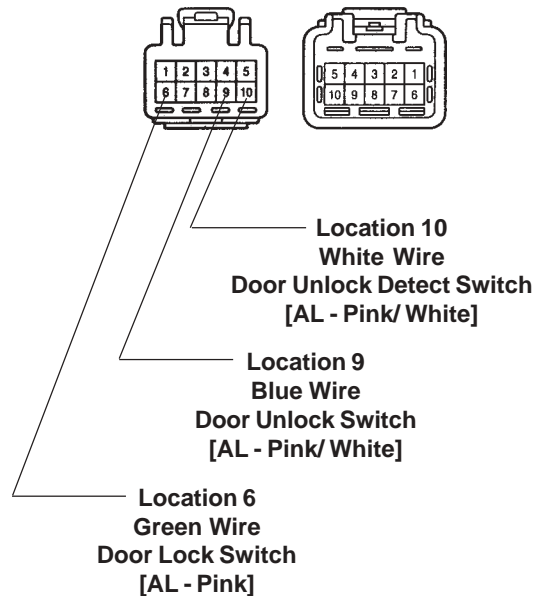

SERVICE PARTS

ITEM	QUANTITY	PART NUMBER	DESCRIPTION
1.	1	00016 - 79200-01	Main Keyless Entry Control Module
2.	2	00016 - 34030-05	Keyless Entry Transmitter
3.	1	00016 - 32901-01	Main Wiring Harness
4.	1	00016 - 30960-56	ON/OFF Toggle Control Switch
5.	1	00016 - 32901-02	Miscellaneous Hardware Kit

INSTALLATION PREPARATION

Before starting installation

1. Familiarize yourself with the installation instructions.
2. Inspect kit components (Refer to kit contents and hardware bag contents).

VEHICLE PREPARATION

1. Place protective coverings on vehicle.



2. **IMPORTANT !**

Disconnect the Vehicle's Negative Battery Cable

3. Refer to the vehicle repair manual, and remove the driver's scuff plate, kick panel, lower dash panel and steering column covers to gain access to JB #1, the Driver's Side Kick Panel, and the Ignition Switch Connectors.

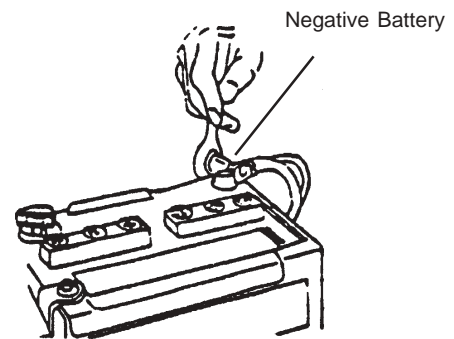

INSTALLING THE KEYLESS ENTRY SYSTEM

MOUNTING THE KEYLESS ENTRY MODULE

1. Secure the main module to the dash brace located to the left of the steering column, using the long cable ties and adhesive pad provided in the hardware bag.

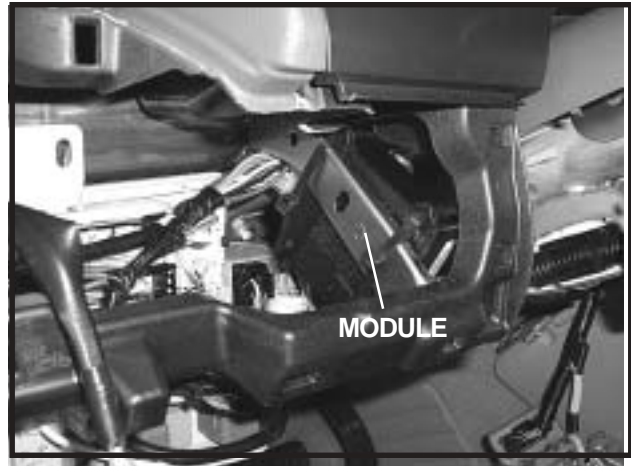

ROUTING THE MAIN HARNESS

1. Route the portion of the harness which includes the Red and Yellow wires under the steering column to the ignition switch connectors. Route the remainder of the harness into the driver's kick panel.

2. Secure the main harness along its routing with the cable ties provided. Be sure that the harness is clear of all sharp and moving objects.



IMPORTANT! Make sure that the brake pedal, accelerator pedal, and accelerator pedal linkages are free and clear of all keyless entry harnesses.

MOUNTING THE TOGGLE SWITCH



1. Carefully drill a 1/4" hole at the location indicated. Measure 1/2" down from the rib on the back side of the driver's kick panel, and 1/2" forward of the rib. Install the switch into the kick panel from the backside. Install the **ON/OFF** bezel and nut. Tighten nut using care not to over torque the switch.

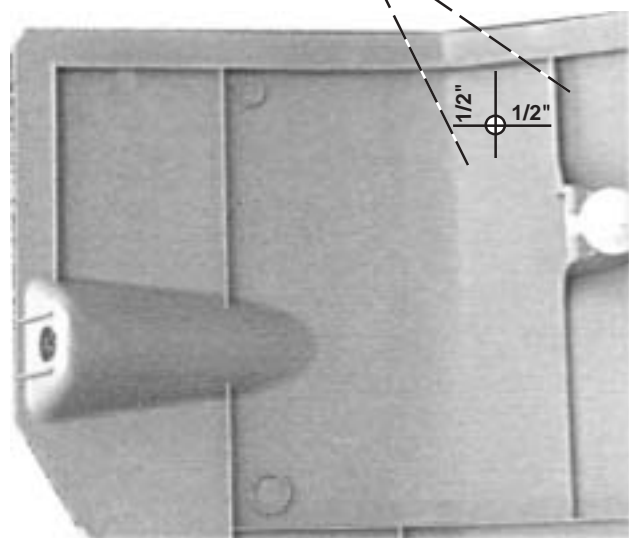
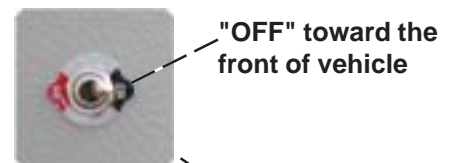

CONNECTING THE MAIN HARNESS

1. Carefully follow the wiring diagram and factory connector details found on the following two pages.

WIRING DIAGRAM - 2007 Camry Keyless Entry

WIRING DIAGRAM

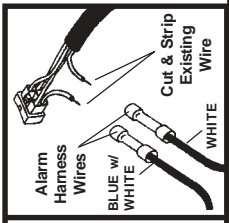
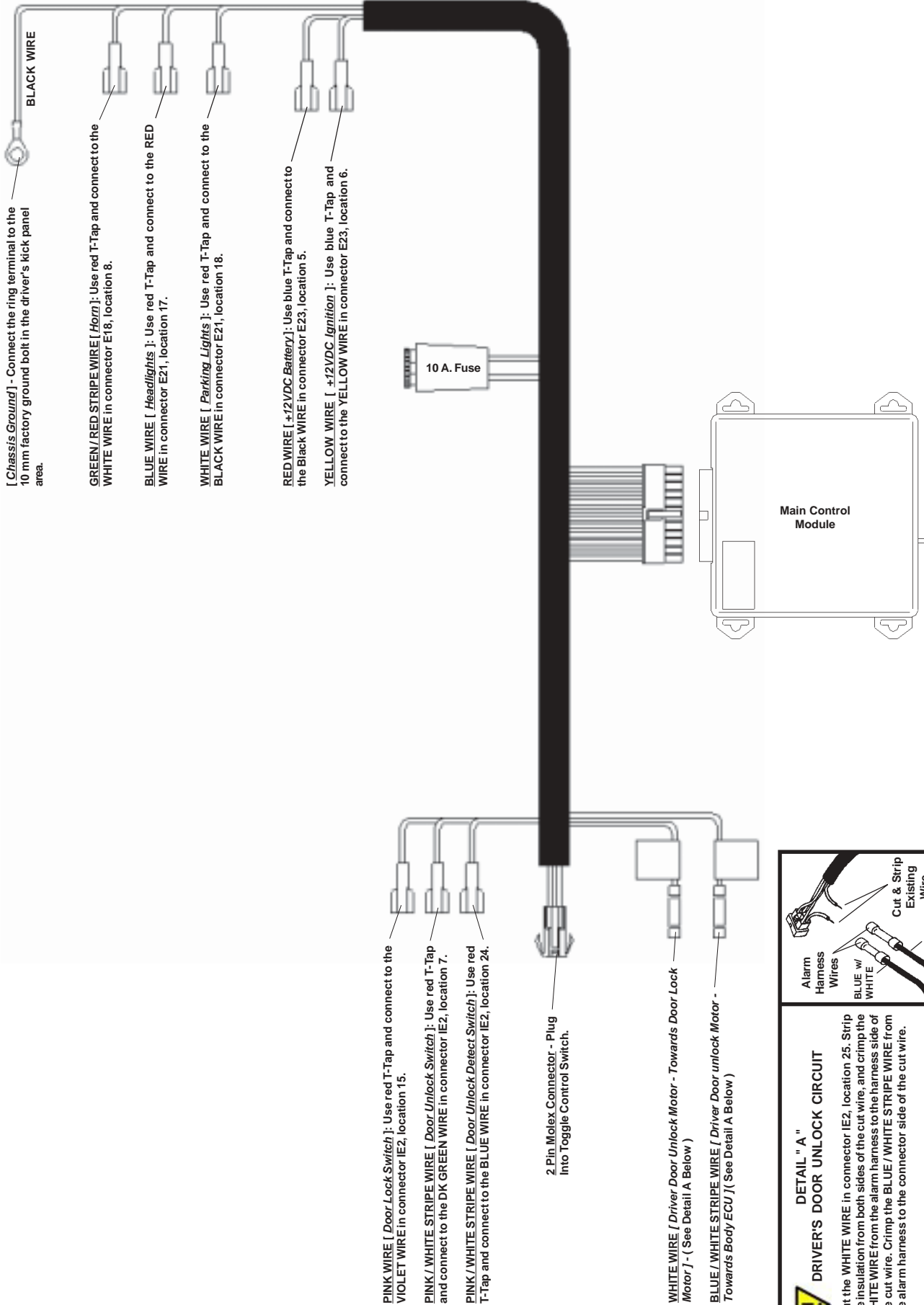

DETAIL "A"

DRIVER'S DOOR UNLOCK CIRCUIT

Cut the WHITE WIRE in connector IE2, location 25. Strip the insulation from both sides of the cut wire, and crimp the WHITE WIRE from the alarm harness to the harness side of the cut wire. Crimp the BLUE / WHITE STRIPE WIRE from the alarm harness to the connector side of the cut wire.

CONNECTOR DETAILS - 2007 Camry Keyless Entry

1. CONNECTOR E23: Ignition Switch

Location : At Back Of Ignition Switch, behind lower Steering Column Cover Panel.

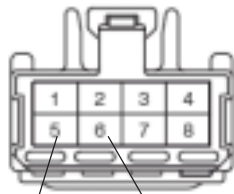

Connector E23
Location 5
Black Wire
+12 VDC Battery
[AL - Red]

Connector E23
Location 6
Yellow Wire
+12 VDC Ignition
[AL - Yellow]

2. CONNECTOR E18 : Horn

Location : Top of Steering Column, at Spiral Cable.



Location 8
White Wire
Horn
[AL - Green/ Red]

BLACK

3. CONNECTOR E21 : Comb. Switch

Location : Top of Steering Column, at Headlight Switch.

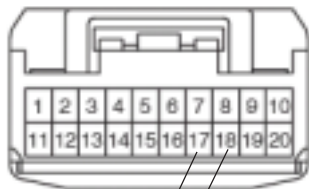

Location 18
Black Wire
Parking Lights
[AL - White]

Location 17
Red Wire
Headlights
[AL - Blue]

4. CONNECTOR IE2 : Door Locks

Location : Driver's Kick Panel.

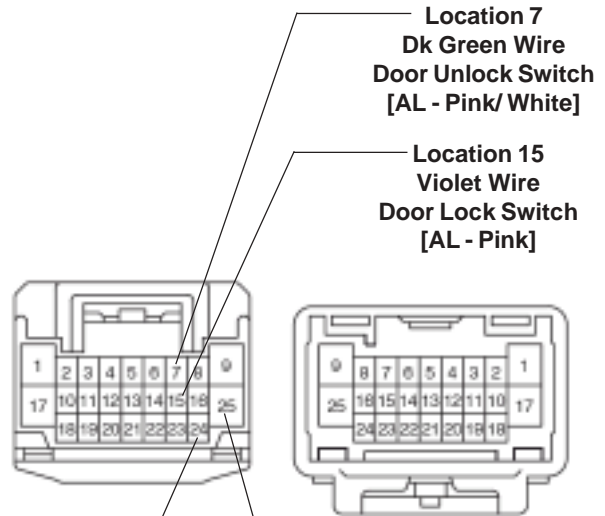

Location 7
Dk Green Wire
Door Unlock Switch
[AL - Pink/ White]

Location 15
Violet Wire
Door Lock Switch
[AL - Pink]

Connector IE2
Location 25
White Wire
Driver's Door Unlock Motor
[AL - White & Blue/ White]

Location 24
Blue Wire
Door Unlock Detect Switch
[AL - Pink/ White]

2006 COROLLA
2007 CAMRY
KEYLESS ENTRY SYSTEM

COMPLETING THE INSTALLATION

TESTING THE SYSTEM:

1. Prior to delivering the vehicle, test all features of the system according to the owner's manual included.

LOCK - Press and release the LOCK button on the transmitter. All doors should lock, headlight come.

UNLOCK - Press and release the UNLOCK button on the transmitter. The driver's door should unlock, headlights come on.

Press and release the UNLOCK button again. All doors should unlock.

Press and hold the PANIC button. The horn should sound and the parking lights should flash.

Press and release the PANIC button to silence the alarm.



NOTE : Be sure to test both transmitters that were included in the kit.

ASSEMBLE ALL REMOVED PANELS TO THE VEHICLE :

1. Refer again to the vehicle repair manual and re assemble all panels that were removed for installation back onto the vehicle. **Test thoroughly, all mechanical and electrical components disconnected and or removed from the vehicle during the installation of this accessory.**



PREPARING THE VEHICLE FOR DELIVERY:

1. To set the arm / disarm chirps to "soft" chirps.
2. Start with the doors in the unlocked position, Toggle Control switch in the "OFF" position.
3. Turn the ignition key to the on position.
4. Turn the ignition key off, then immediately switch the Toggle Control Switch "ON" then "OFF" 4 times.
5. The vehicle horn should respond with soft horn chirps.