

Toyota Highlander 2016 Frameless® EC Mirror w/ Compass & HomeLink®



Part Number: 00016-05464

Accessory Code: ME4010

Note: This accessory requires replacement A-Pillar clips 62217-52120 and 62217-0E040 to complete the installation for this vehicle.

Conflicts

Note: **Factory HomeLink**

Kit Contents

Item #	Quantity Req'd.	Description
1	1	Frameless® Mirror w/Compass & HomeLink®
2	1	Wire Harness Cover
5	1	Main Power Wire Harness

Hardware Bag Contents

Item #	Quantity Req'd.	Description
1	3	Red T-Taps
2	10	Wire Ties
3	6	Foam Tapes
4	1	Quick Reference Guides

Additional Items Required For Installation

Item #	Quantity Req'd.	Description
1	1	Lower A-Pillar Clip (62217-52120)
2	1	Upper A-Pillar Clip (62217-0E040)

Recommended Tools

Safety Tools	
Safety Glasses	
Special Tools	
Installation Tools	
Needle Nose Pliers	10mm Socket
Screw Gun	Torque Wrench-48inch lbs (Car Battery)
T20 Torx Bit/Driver	Ratchet/Driver
#2 Phillips Bit	Dark Towel/ Cloth
Nylon Tool	Torque Wrench-15.5 inch lbs
Special Chemicals	

Service Part Numbers

Part Description	Part Number
Frameless® EC Mirror w/Compass and HomeLink®	00016-05464-01
Main Power Wire Harness	00016-05464-02
Lower A-Pillar Clip	62217-52120
Upper A-Pillar Clip	62217-0E040

General Applicability

All models except factory installed HomeLink

Recommended Sequence of Application

Item #	Accessory
1	
2	
3	

*Mandatory

Legend

STOP: Damage to the vehicle may occur. Do not proceed until process has been complied with.

OPERATOR SAFETY: Use caution to avoid risk of injury.

CAUTION: A process that must be carefully observed in order to reduce the risk of damage to the accessory/vehicle and to ensure a quality installation.

TOOLS & EQUIPMENT: Used in Figures calls out the specific tools and equipment recommended for this process.

REVISION MARK: This mark highlights a change in installation with respect to previous issue.

SAFETY TORQUE: This mark indicates that torque is related to safety.

SPECIAL NOTE: Installation Sequences

After TMS and Safety mandated preparatory steps have been taken, the installation sequence is the suggested method for completing the accessory installation. In some instances the suggested sequence is written for one associate to install and in others the sequence is given as part of a team accessory installation. Unless otherwise stated in the document, the associates may perform the installation steps in any order to make the installation as efficient as possible while maintaining consistent quality.

Care must be taken when installing this accessory to ensure damage does not occur to the vehicle. The installation of this accessory should follow approved guidelines to ensure a quality installation.

These guidelines can be found in the "Accessory Installation Practices" document.

This document covers such items as:

- Vehicle Protection (use of covers and blankets, cleaning chemicals, etc.).
- Safety (eye protection, rechecking torque procedure, etc.).
- Vehicle Disassembly/Reassembly (panel removal, part storage, etc.).
- Electrical Component Disassembly/Reassembly (battery disconnection, connector removal, etc.).

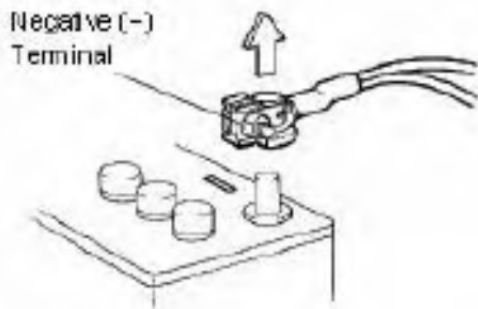

Figure 1

1. Disconnect the negative battery cable. Isolate the cable with protection in place. See Figure 1.



Wait at least 90 seconds after disconnecting the cable from the negative (-) battery terminal to disable the SRS system.

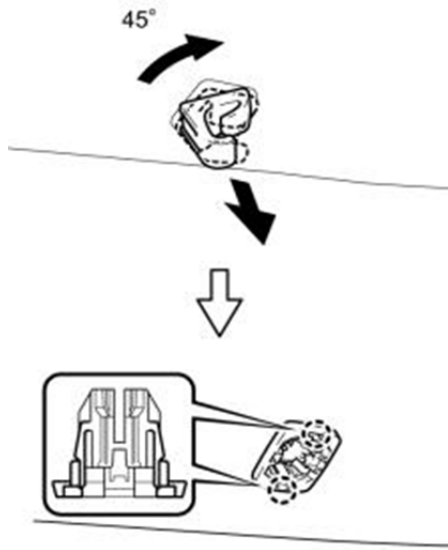

Figure 2

2. Remove the driver side visor holders. Turn the holder clockwise approximately 45° and pull it as shown in the illustration. Detach the 2 claws and remove the visor holder. See Figure 2

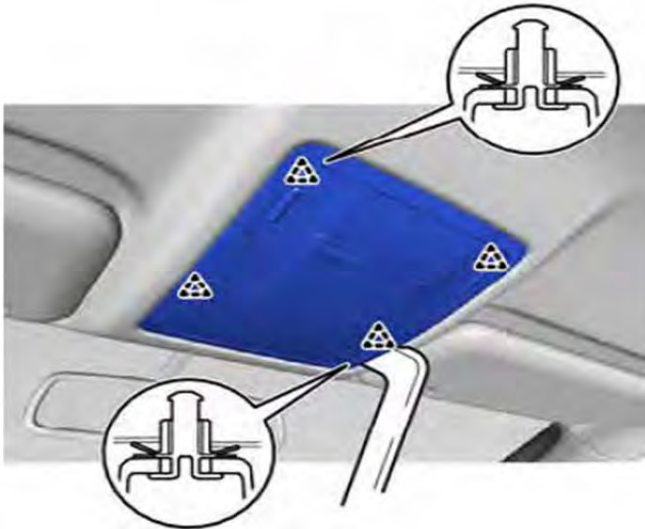

Figure 3

3. Detach the 4 clips. Disconnect the connector to remove the roof console box. See Figure 3.

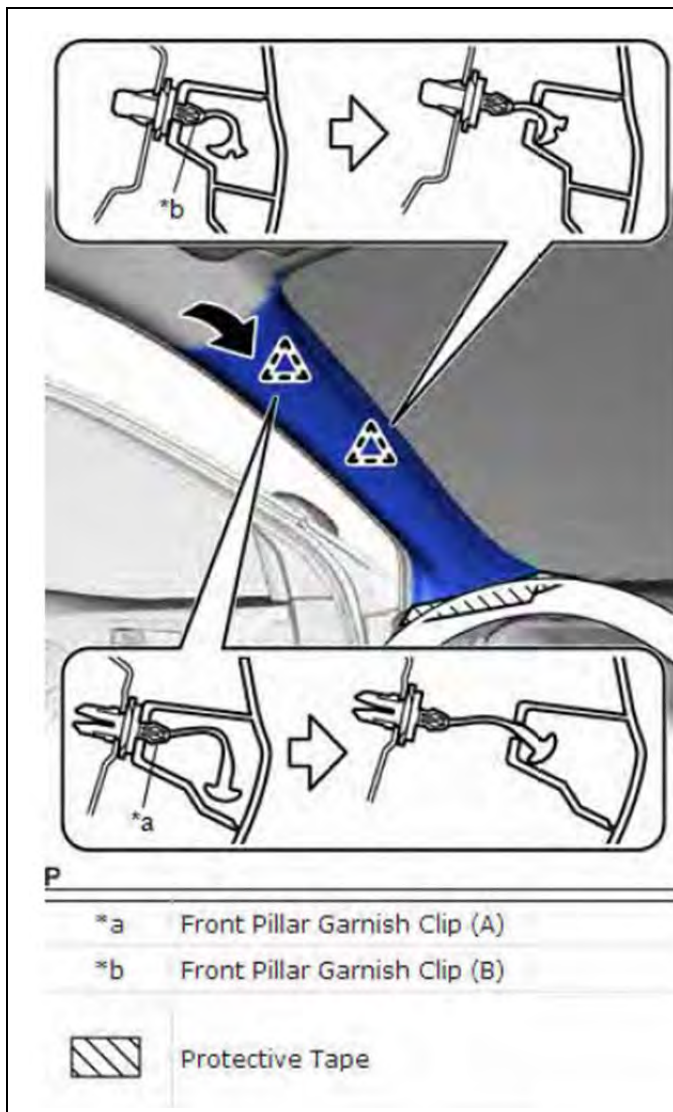

Figure 4

4. Pull the upper part of the front LH pillar garnish toward the inside of the cabin and disengage from the base of the 2 front pillar garnish clips. See figure 4.

HINT: Let the front LH pillar garnish hang from the 2 front pillar garnish clips.

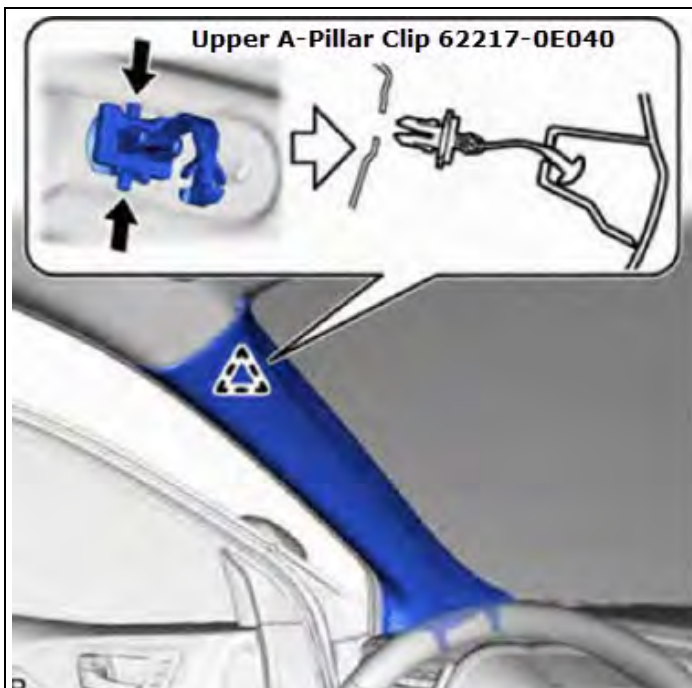

Figure 5

5. While pushing the tabs on the LH front A-Pillar garnish clip (A) in the direction indicated by the arrow shown in the illustration, disengage the LH front A-Pillar garnish clip (A). Remove the LH front A-Pillar clip from the A-Pillar. The clip CAN NOT be reused. DESTROY and DISPOSE of clip. See figure 5.



NOTE: Install a new A-Pillar garnish upper clip when replacing A-Pillar garnish at the end of installation. Upper A-Pillar clip 62217-0E040 is not provided in the mirror kit. This item must be

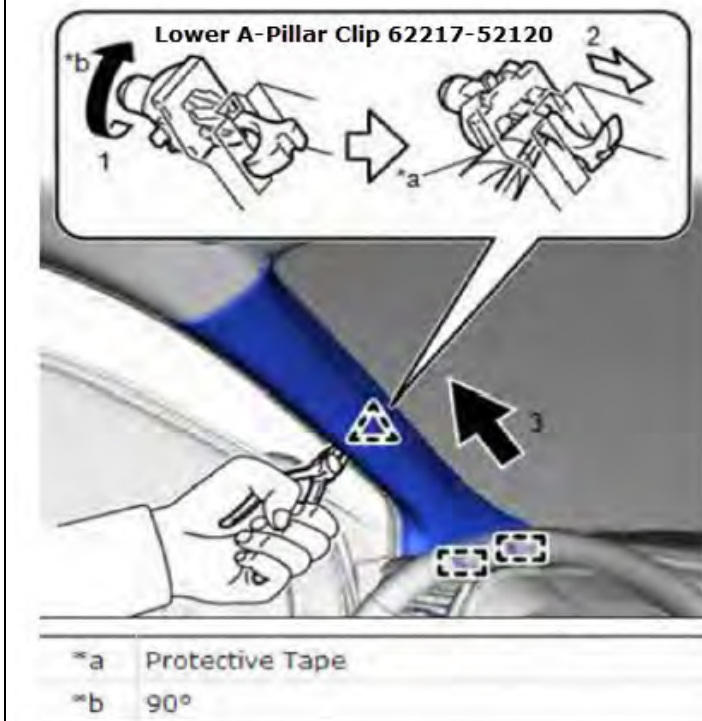
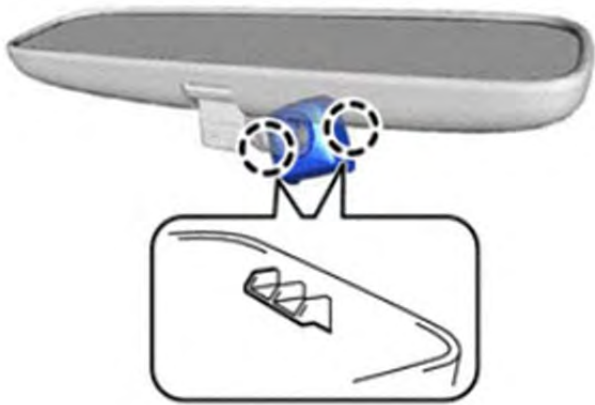

Figure 6

6. Using needle-nose pliers with the tips wrapped with protective tape, rotate the front pillar garnish clip (B) 90° in the direction indicated by the arrow (1) shown in the illustration. Pull the LH front pillar garnish in the direction indicated by the arrow (2) shown in the illustration to disengage it from the front pillar garnish clip (B). Pull the LH front pillar garnish in the direction indicated by the arrow (3) shown in the illustration to disengage the 2 guides to remove the LH front pillar garnish. Remove the LH front A-Pillar clip from the A-Pillar. The clip CAN NOT be reused. DESTROY and DISPOSE of clip. See figure 5. See figure 6.



NOTE: Install a new A-Pillar garnish lower clip when replacing A-Pillar garnish at the end of installation. Lower A-Pillar clip 62217-52120 is not provided in the mirror kit. This item must be



7. Disengage the 2 claws and disconnect the inner mirror base cover. See figure 7.

Figure 7

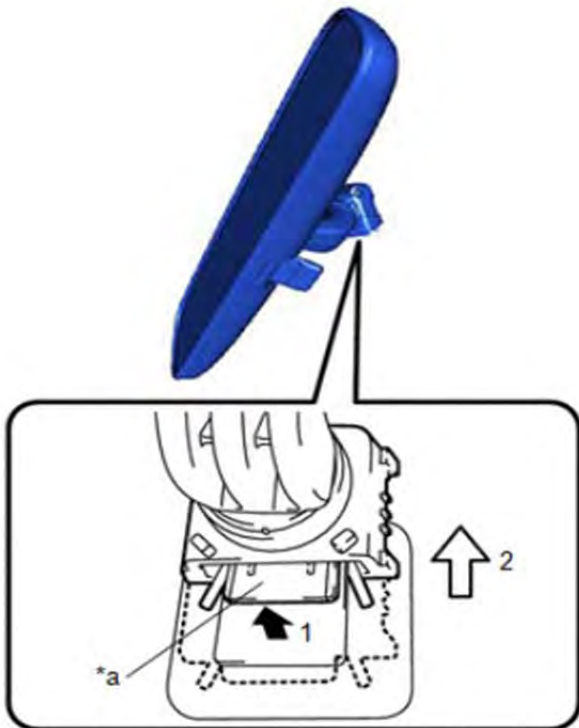

8. Pull the lock lever in the direction indicated by the arrow (1) in the illustration, and slide the inner rear view mirror assembly in the direction indicated by the arrow (2) to remove it. See figure 8.

*a Lock Lever

Figure 8



Note: Remove fingerprints, smudges, dirt, etc. from mirror and windshield with glass cleaner.

Figure 9a

9. Mount the Frameless® EC Mirror w/Compass in reverse of original factory mirror removal. Slide and attach the rearview mirror assembly and tighten mirror set screw with a T20 torx bit or driver. DO NOT over tighten screw. See figure 9a and 9b.

Torque: 15.5 in.*lbf



Do not use power tools to tighten screw. Hands tighten only.

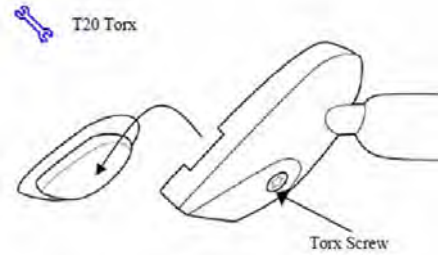

Figure 9b

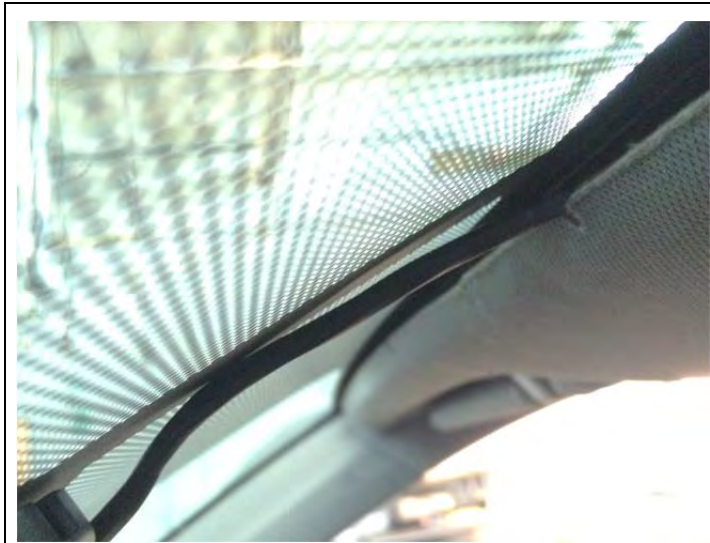

Figure 10

10. Route the mirror harness to overhead console opening using the precut notches on the front of the headliner. See figure 10.

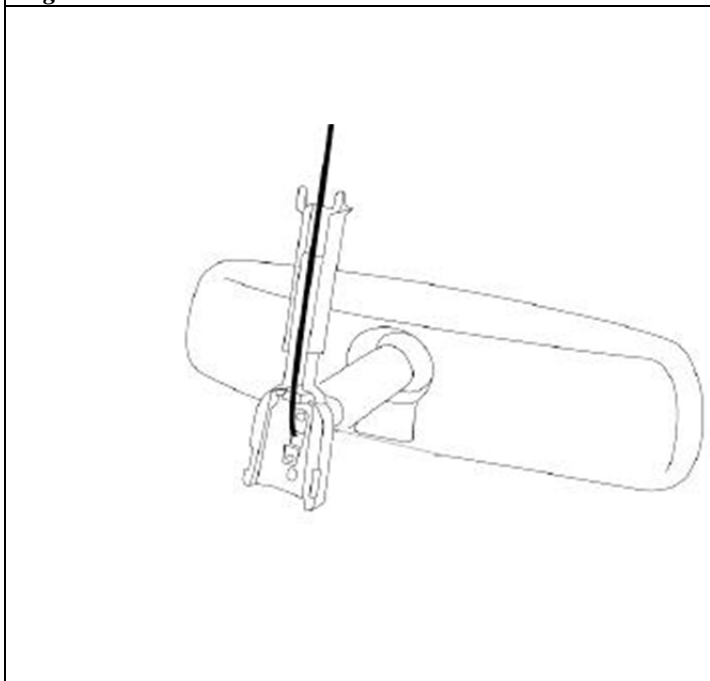

Figure 11a

11. Install the wire harness cover over the wire harness. Seat the bottom of the cover securely to base of the mirror. Extend the top of the cover fully into headliner. See figure 11a and 11b.



Figure 11b

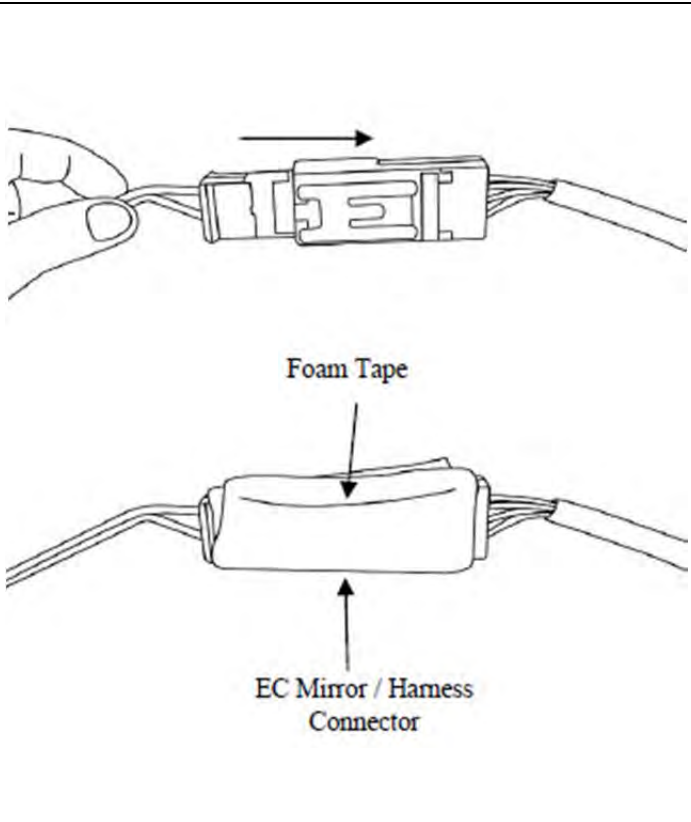

Figure 12

12. Connect the mirror harness to the mirror main power harness. Make sure both connectors are fully engaged. Wrap foam tape around connectors. See figure 12.

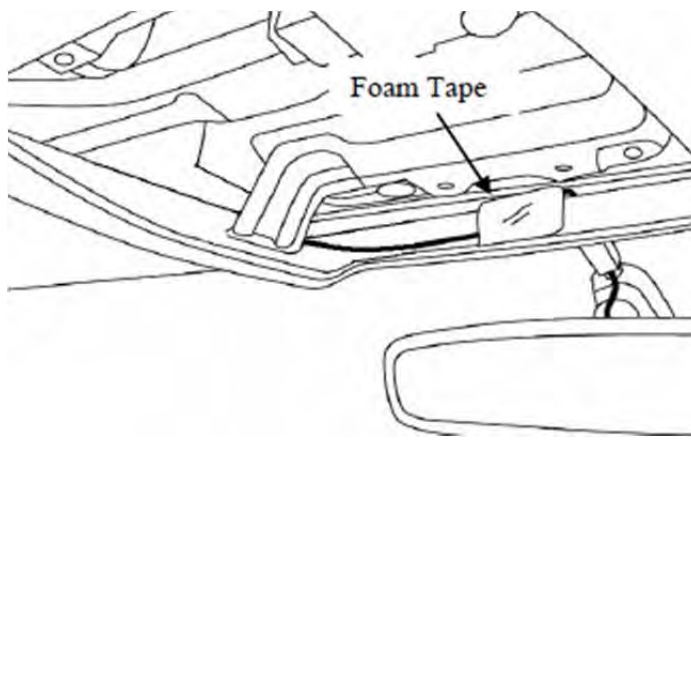
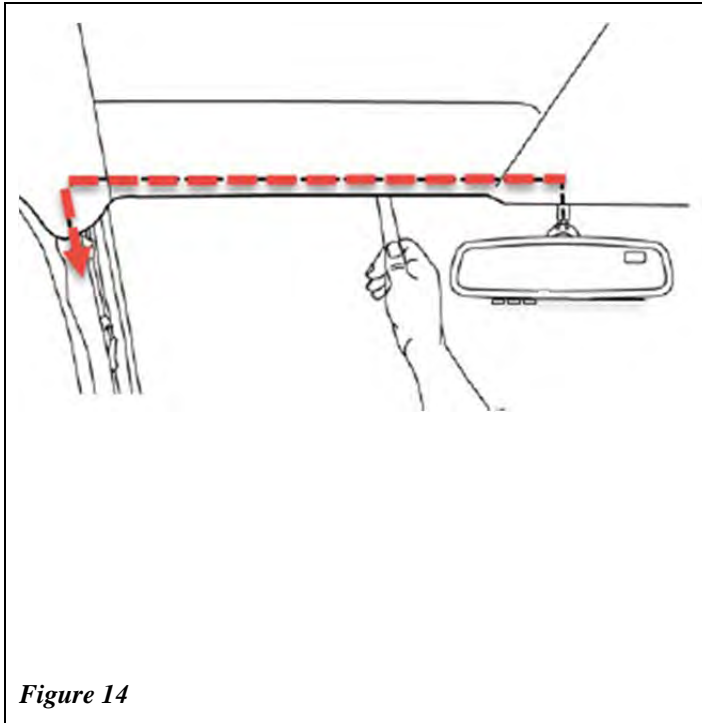

Figure 13

13. Secure the harness to the front center of the headliner with one (1) piece of foam tape. See figure 13.



14. Route mirror main power harness along front edge of headliner towards the LH vehicle A-Pillar. See figure 14.

Figure 14

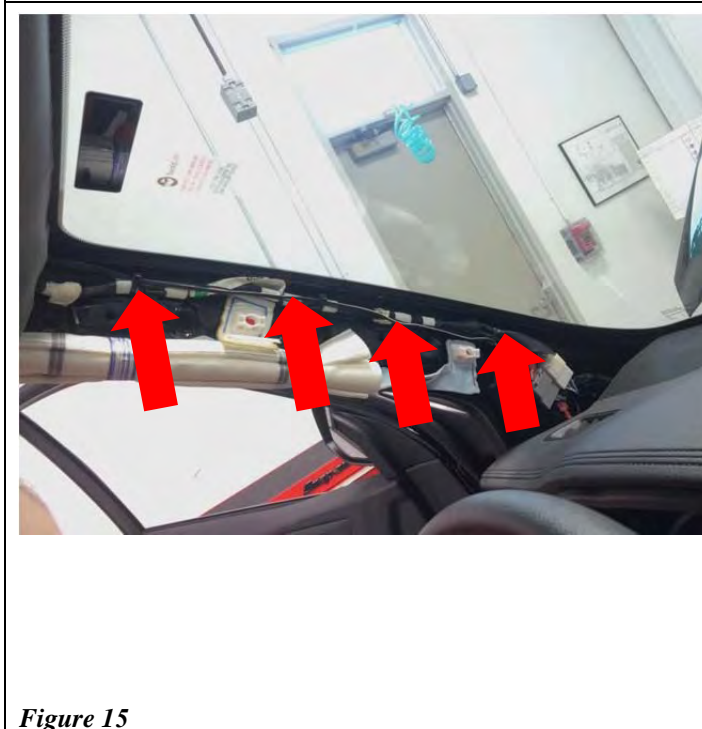

15. Route the mirror harness down to the bottom of the Front LH pillar. Route the harness through the factory harness clips attached to the vehicle. Wire tie the harness to the vehicle harness as shown. See figure 15.

Figure 15

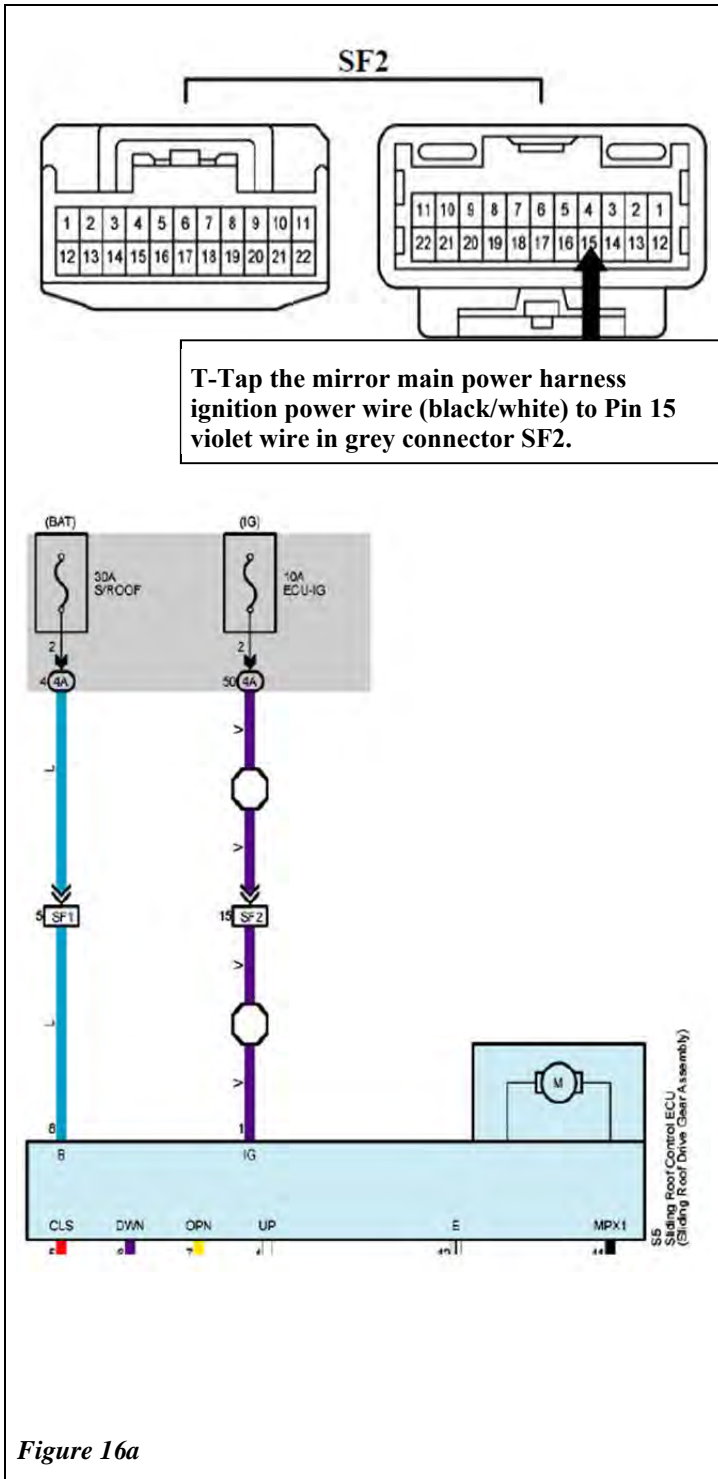

16. Locate vehicle connector SF2 in the front LH pillar. Disconnect connector and pull the factory tape back. T-Tap the mirror main power harness ignition power wire (black/white) to Pin 15 violet wire in grey connector SF2. See figure 16a and figure 16b.

Figure 16b

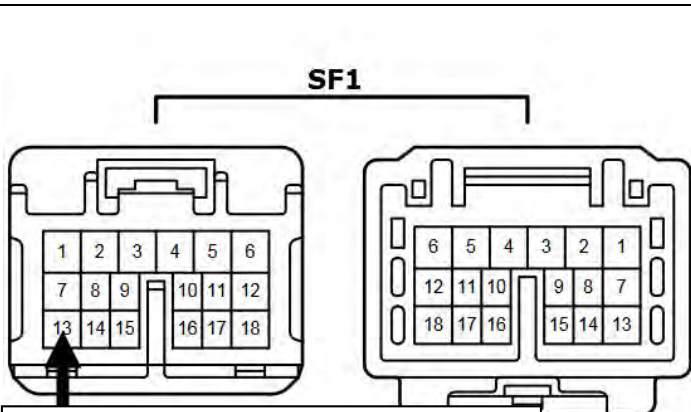

T-Tap the mirror main power harness ground wire (black/orange) to Pin 13 white/black wire in white connector SF1.

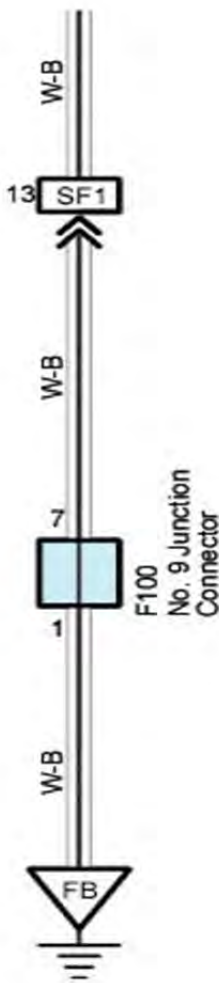

Figure 17a

17. Locate vehicle connector SF1 in the Front LH pillar. Disconnect connector and pull the factory tape back. T-Tap the mirror main power harness ground wire (black/orange) to Pin 13 white/black wire in white connector SF1. See figure 17a and figure 17b.

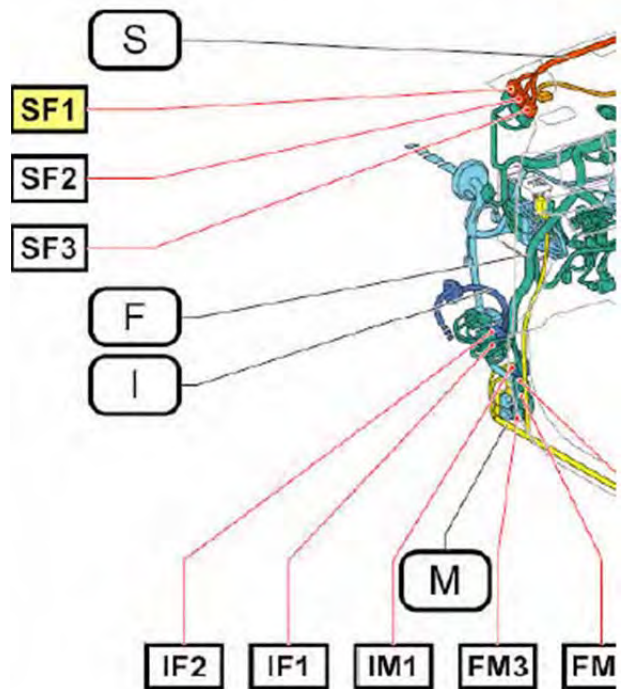

Figure 17b

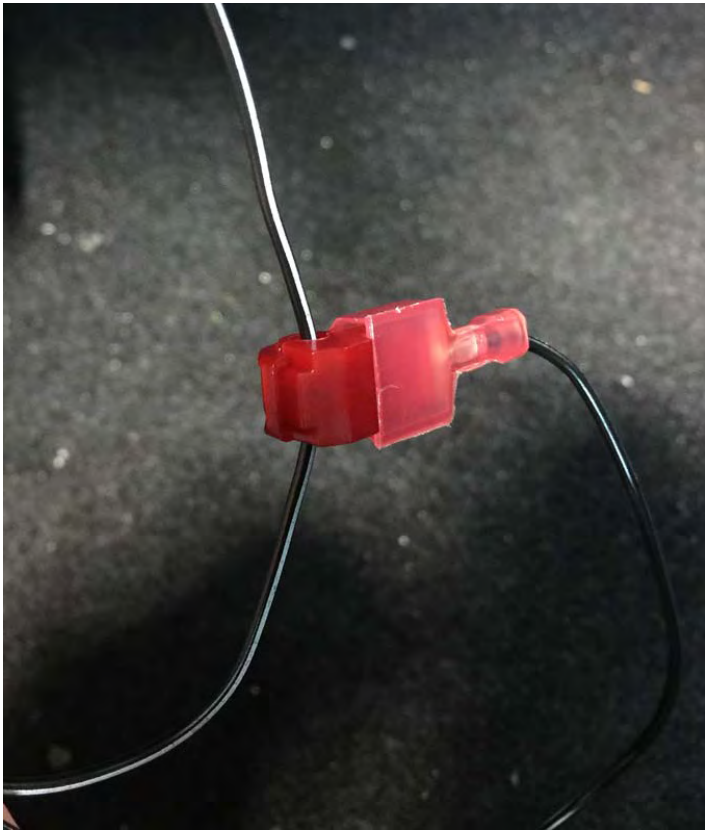

Figure 18

18. T-Tap the mirror main power harness power wire (black) to the mirror main power harness ignition wire (black/white). See figure 18.

Figure 21

19. Bundle up any excess wire above the headliner and secure it to the vehicle harness near the overhead console.



20. Engage the 4 clips to install the map light assembly. See Figure 20.

Figure 20

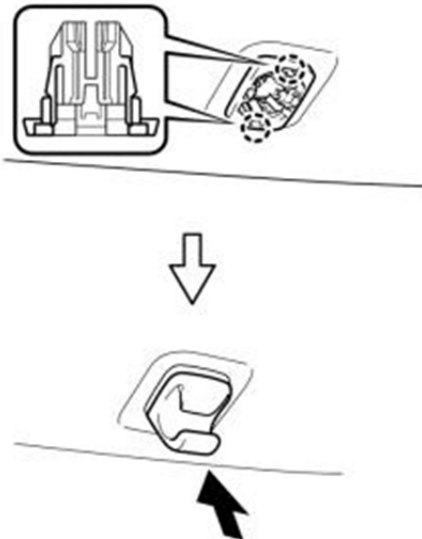

21. Engage the two claws. Push in the visor holder to install as shown in figure 21.

Figure 21

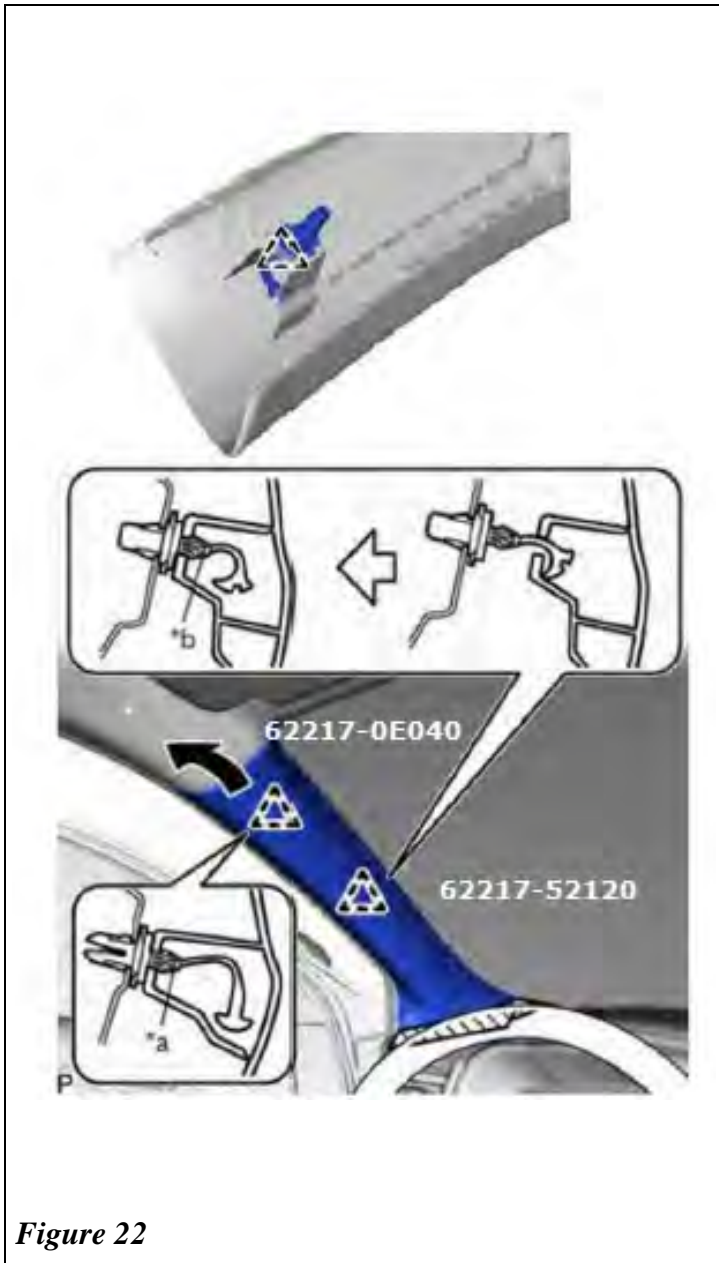

22. Install the New A-Pillar garnish upper clip 62217-0E040 to vehicle A-Pillar garnish. Install the New A-Pillar garnish lower clip 62217-52120 to vehicle A-Pillar garnish.

STOP **NOTE: Install a new A-Pillar garnish upper clip and lower clip when installing garnish. DO NOT reuse the old clips. THE CLIPS MUST BE REPLACED.**

Lower A-Pillar clip 62217-52120 and upper A-Pillar clip 62217-0E040 is not provided in the mirror kit. This item must be ordered separately.

Engage the front pillar garnish clips to the front LH pillar garnish. Install the LH front pillar garnish back onto vehicle. See figure 22.

Figure 22

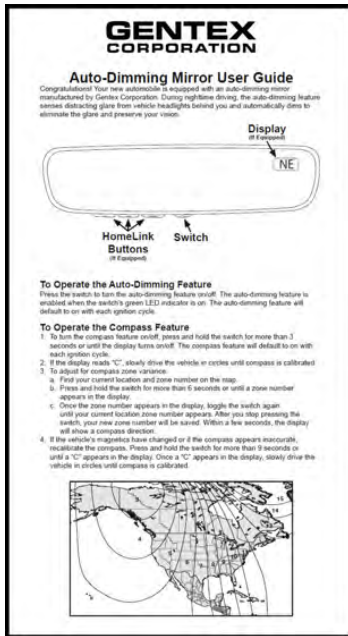

Figure 23

23. Place owner's card in the glove box. See figure 23.

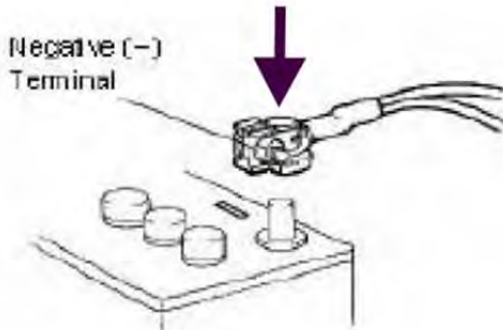

Figure 24

24. Connect the negative battery cable.



Torque: 48in.*lbf

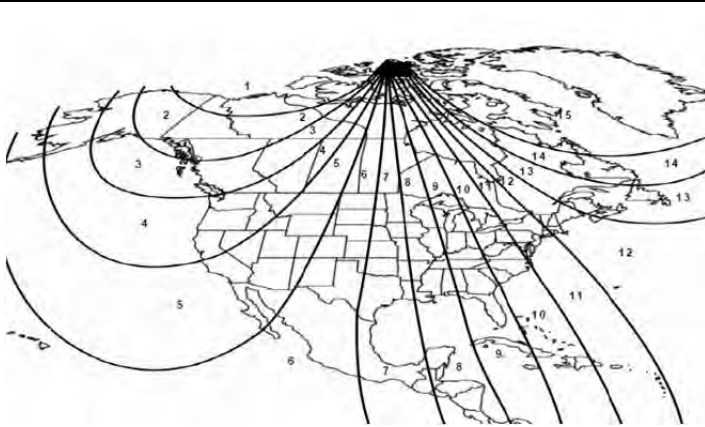

Figure 25b

25. Compass Zone Setting

(a) With display turned ON, push the mirror power button for 3 seconds or until a number is displayed in the display window.

(b) Refer to the Zone Map and toggle button until correct zone is displayed. See figure 25b.

(c) Release button.

(d) The display will return to normal compass mode (showing either a "C" or a directional heading) within 10 seconds of no switch activity.

26. Calibrate Compass

(a) If a "C" is displayed in window, drive the vehicle in one circle at less than 5 mph.

(b) Correct compass heading should now be displayed.

NOTE: Correct compass zone must be selected prior to compass calibration to ensure accurate calibration. If the vehicle is driven in a new zone, repeat zone selection procedure.

Checklist - these points **MUST** be checked to Ensure a quality installation.

Check: After Installation

- Vehicle should be in a fairly well lit area. Turn ignition (ACC power) to ON.

Auto-dimming feature:

- Cover the forward-looking light sensor (located on the back of the mirror).

Mirror clears:

- Remove cover from photocell.

Compass Feature:

- Look at the mirror compass display.

- Operation Instruction Cards

HomeLink Feature:

- Look at the mirror's (3) HomeLink buttons.

- Press the mirror's (3) HomeLink buttons.

Overhead Console:

- Check dome light.

- Check the Sunroof if applicable.

Look For:

Verify green LED is on. If it is not ON press ON / OFF button - confirm LED is ON.

Verify mirror darkens.

Mirror returns to clear state.

Correct compass heading should now be displayed. If a "C" is displayed in window, calibrate the compass.

Place in the vehicle glove box.

Verify all (3) buttons are illuminated when the vehicle ignition is ON.

HomeLink icon will appear in mirror. Press button again to stop the icon from flashing.

Verify the dome light functions properly.

Verify the sunroof functions properly.

Block Diagram
Frameless® EC Mirror w/Compass & HomeLink®

Applies to SET P/N 00016-05464 2016 Highlander

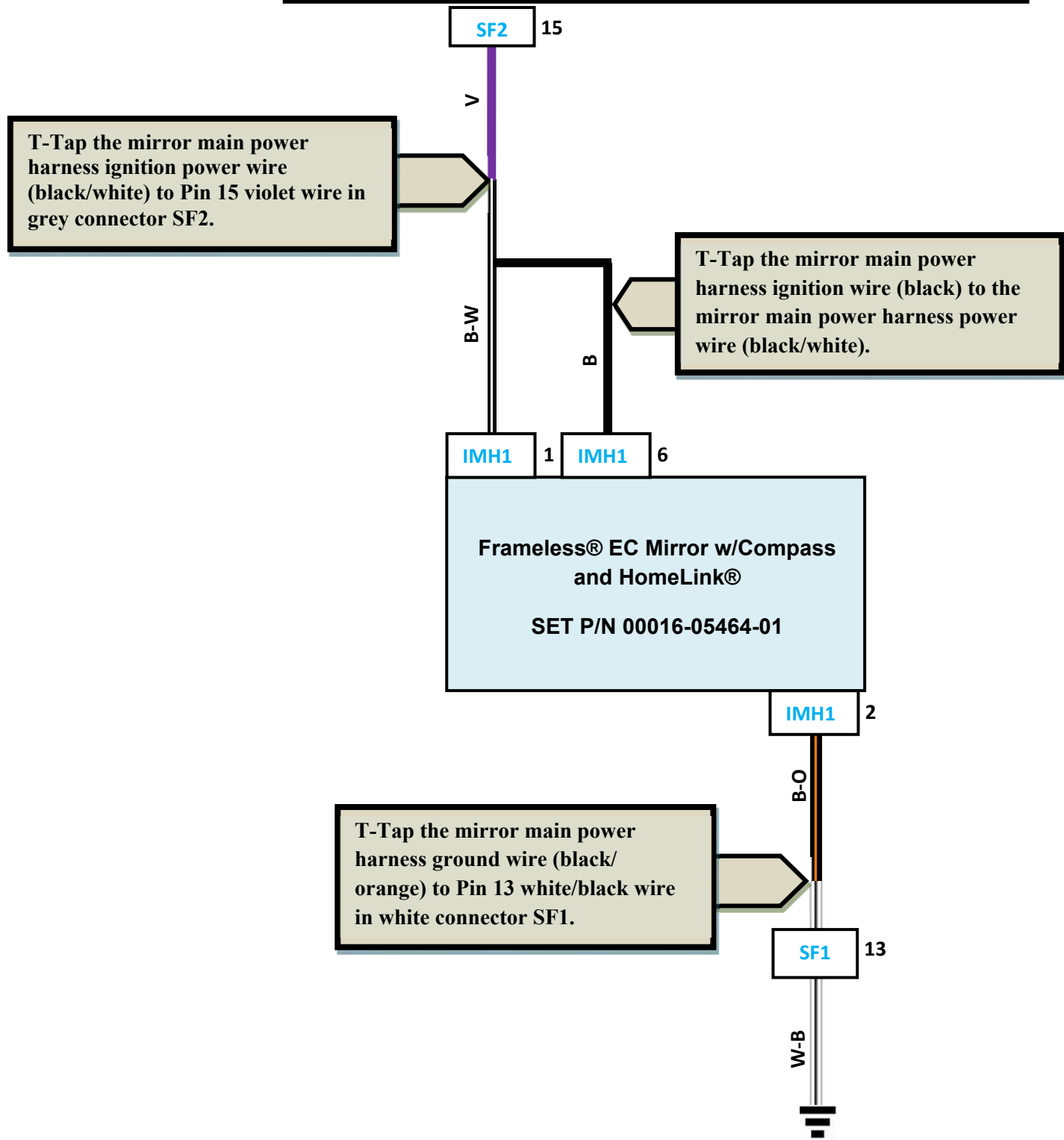

Checking the Harness Pin outs:

Connector IMH1: Frameless® EC Mirror w/Compass Power Harness Connector

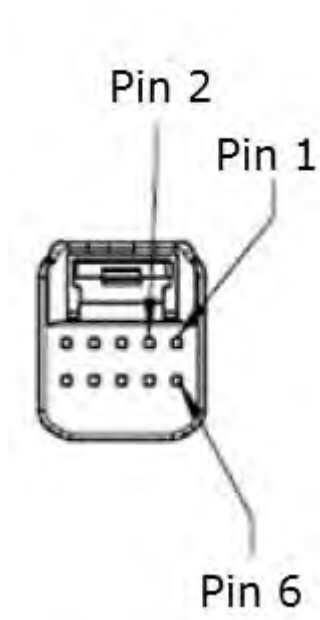

Connector view is from the front (pin side)

If feedback from the harness on any of the pins does not match the results shown in the Proper Operation field below, check the connection to the vehicle wiring and re-test.

Pin	Wire Color	Test Reference	Proper Operation
1	Black w/White Trace	Pin 1 to ground	Approx. 12 VDC with switch in ON position Approx. 0 VDC with switch in OFF position
2	Black w/Orange Trace	Pin 2 to ground	Always Continuity
6	Black	Pin 3 to ground	Approx. 12 VDC with switch in ON position Approx. 0 VDC with switch in OFF position

Pin	Wire Color	Circuit
1	Black w/White Trace	Ignition
2	Black w/Orange Trace	Ground
6	Black	Battery

Vehicle Connector SF2-Power Circuit

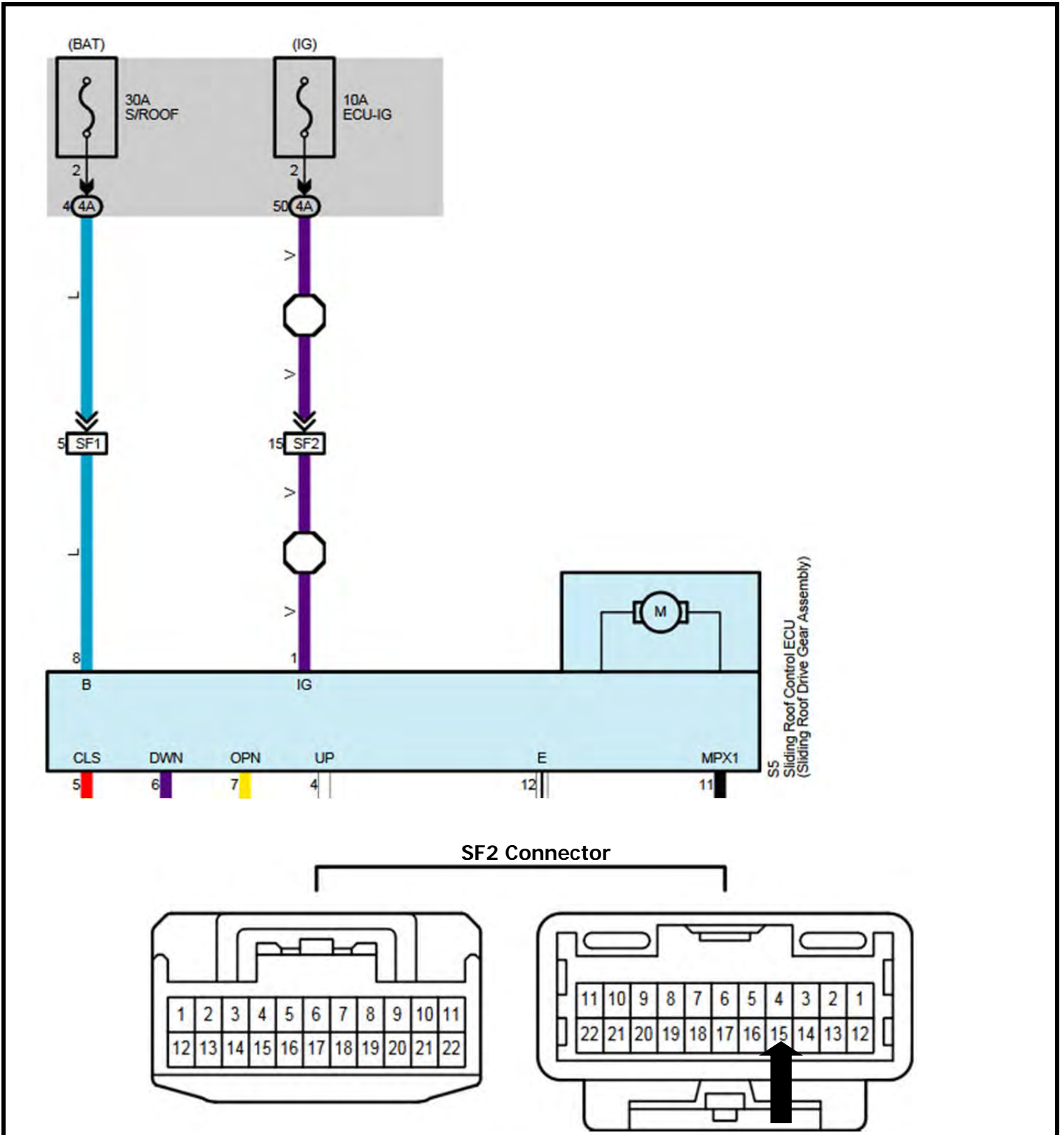

Vehicle Connector SF1-Ground Circuit

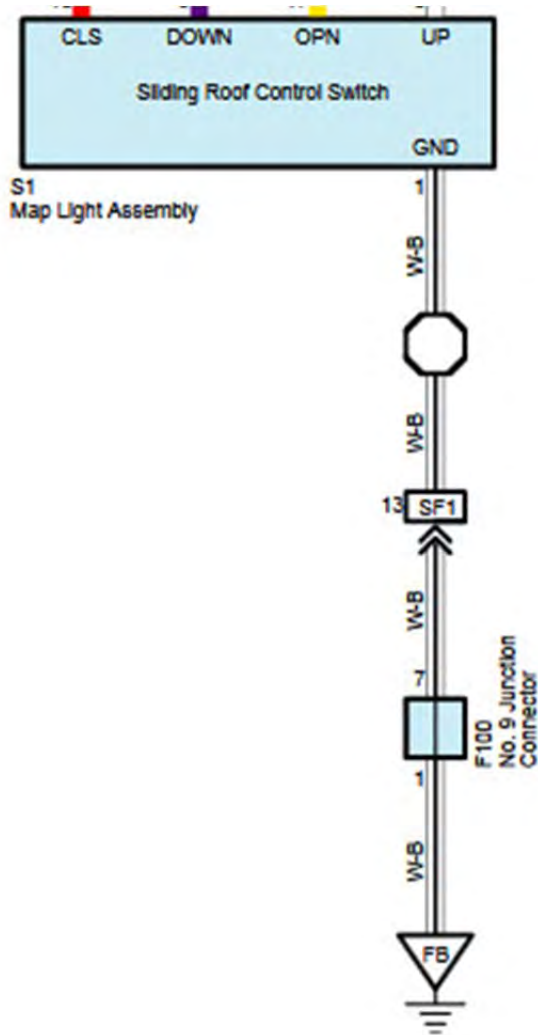

SF1 Connector

