



Southeast Toyota Distributors, LLC

**Southeast Toyota Distributors, LLC  
Accessory Installation Instructions**

**2019 4Runner  
Rear Dual USB Power Port  
(CLA Replacement)**

Year & Model:	2019 4RUNNER
Part Number:	00016-00325
Accessory Code:	CP1000
PIO / DIO:	PIO & DIO
Business Partner:	J56

**Conflicts**

Note: None
------------

**General Applicability**

Fits Models:
1. All Models

**Additional Items Required For Installation**

Item#	Description:
1	N/A

**Sequence of Application**

Item#	Accessory:
1	N/A



**SPECIAL NOTE: Installation Sequences**

After TMS & Safety mandated preparatory steps have been taken, the installation sequence is the suggested method for completing the accessory installation. In some instances the suggested sequence is written for one associate to install & in others the sequence is given as part of a team accessory installation. Unless otherwise stated in the document, the associates may perform the installation steps in any order to make the installation as efficient as possible while maintaining consistent quality.

**Recommended Tools**

<b>Safety Items</b>	
Safety Glasses	Safety Gloves
<b>Special Tools</b>	
Volt Meter (USB Tester)	
<b>Installation Tools</b>	
Padded Work Surface	Protective Blanket
Moulding Remover	Pliers
Ratchet/Driver	Side Cutters
Socket (10mm)	Torque Wrench (48 in*lbs)
Grease Pencil	Small Flat Head (Taped)
Masking Tape	CLA Removal Tool
<b>Special Chemicals</b>	
N/A	

**Legend**

-  **STOP:** Damage to the vehicle may occur. Do not proceed until process has been complied with.
-  **OPERATOR SAFETY:** Use caution to avoid risk of injury.
-  **CAUTION:** A process that must be carefully observed in order to reduce the risk of damage to the accessory/vehicle and to ensure a quality installation.
-  **TOOLS & EQUIPMENT:** Used in figures calls out the specific tools and equipment recommended for this process.
-  **REVISION MARK:** This mark highlights a change in installation with respect to previous issue.
-  **SAFETY TORQUE:** This mark indicates that torque is related to safety.
-  **REGULATORY MARK:** This mark indicates that the component is related to regulatory compliance.
-  **VIDEO:** This image indicates a video to show a installation procedure, PIO Only.

**Table of Contents**

---

- I. Preparation.....1-5
  - a. Table of Contents..... 2
  - b. Kit/Hardware & Wire Harness Bag Contents..... 3
  - c. Parts for Installation..... 4
  - d. Service & Warranty Information ..... 5
  
- II. Procedures
  - a. Battery Removal.....6
  - b. Vehicle Disassembly – Installation Process..... 7-18
  
- III. Re-install Battery..... 18
- IV. Function and Quality Checks..... 19
- V. Diagnostic / Block Diagrams & Connector Procedures..... 20-21
- VI. Blank Page ..... 22
- VII. Warranty Statement..... 23-24

**Kit/Hardware Bag Contents:**

<b>Item #</b>	<b>Quantity</b>	<b>Description</b>
1.	1	Dual Smart USB Power Port No Cap
2.	2	RED #951 Female T-Taps
3.	2	BLUE #952 Female T-Taps
4.	2	Foam Tape Squares 2" x 2"
5.	7	Zip Ties 8"

**Parts for Installation:**

Care must be taken when installing this accessory to ensure damage does not occur to the vehicle. The installation of this accessory should follow approved guidelines to ensure a quality installation. These guidelines can be found in the “Accessory Installation Practices” document.

This document covers such items as:

- Vehicle Protection (use of covers and blankets, cleaning chemicals, etc.).
- Safety (eye protection, re-checking torque procedure, etc.).
- Vehicle Disassembly/ Reassembly (panel removal, part storage, etc.).
- Electrical Component Disassembly/Reassembly (battery disconnection, connector removal, etc.).

Item #	Quantity	Description
1.	1	Dual Smart USB Power Port
2.	2	RED #951 Female T-Taps
3.	2	BLUE #952 Female T-Taps
4.	2	Foam Tape Squares 2" x 2"
5.	7	Zip Ties 8"

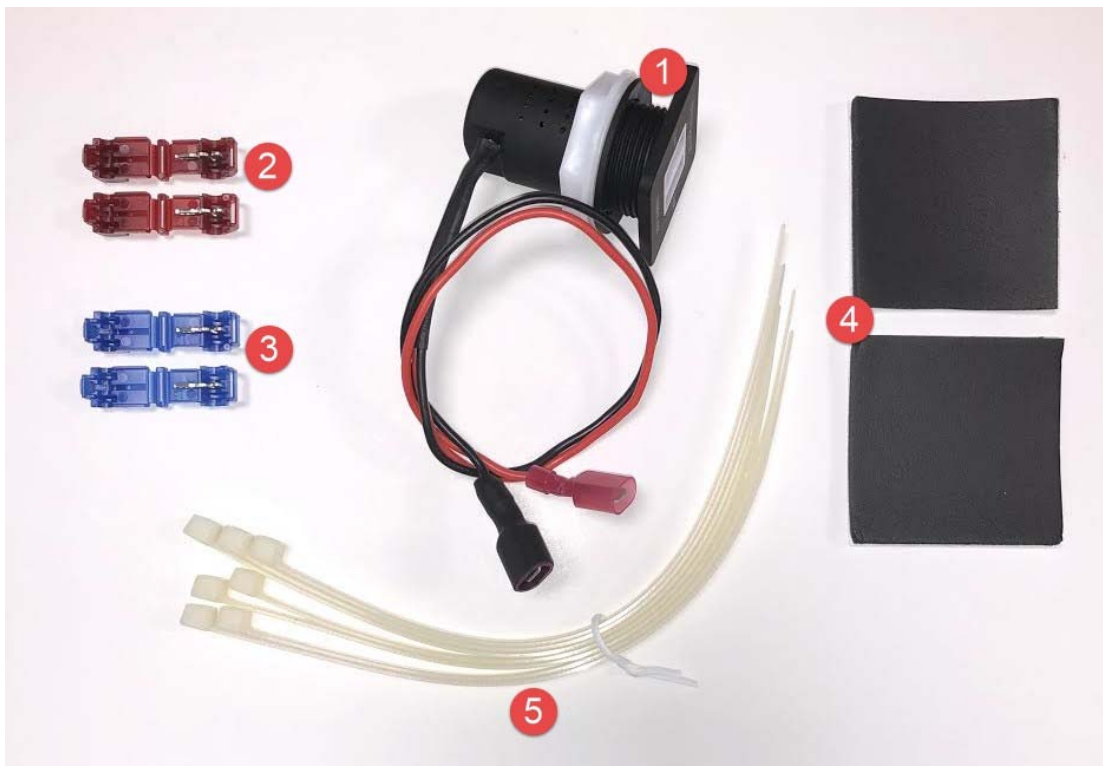

**Service & Warranty Information**

Image Key	Parts Information		Warranty Information	
	Part Number	Description	Warranty Time	Labor Op. Code
A	00016-00325	Dual USB Power Port No Cap	0.3	ACP001

Labor times include consideration for diagnosis and Administration time.  
 If you are a dealer located outside of the Southeast Region, please contact the SET Accessory Warranty Department at (888) 851-2722 or email [Accessory.Warranty@SETToyota.com](mailto:Accessory.Warranty@SETToyota.com) for claim payment instructions.

**Parts:**

**A – Dual USB Power Port Kit**

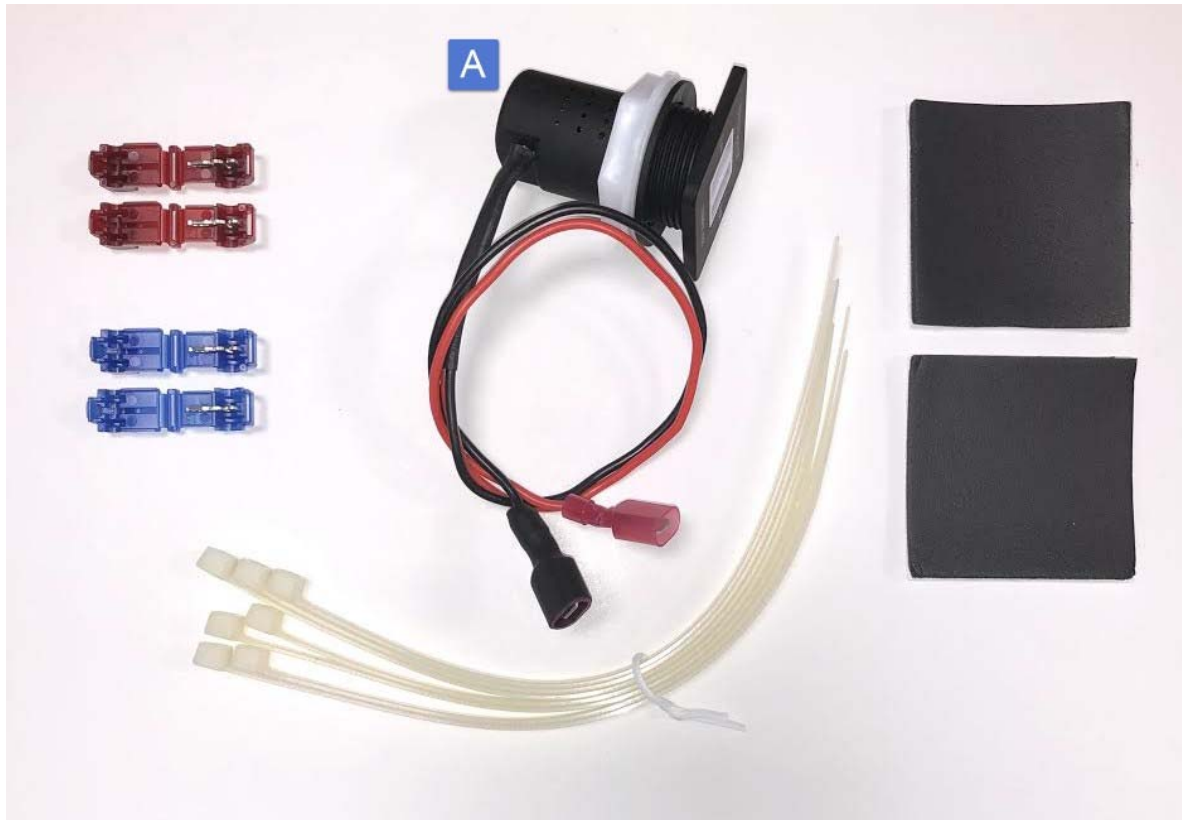

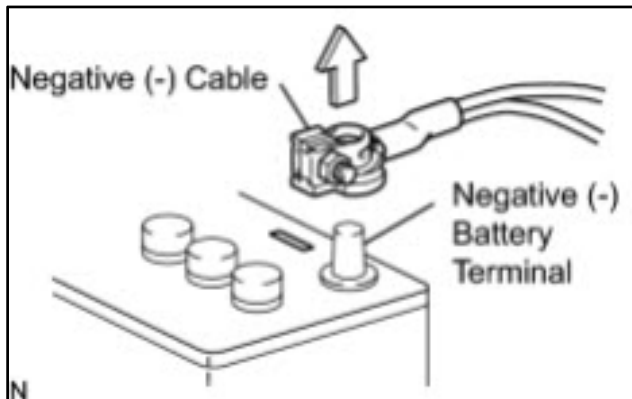

*Figure 1*

## BATTERY REMOVAL

Prepare for the Installation:

- The engine components and coolant may be hot.
- Check the kit for contents and any damage.
- Protect the fender.

Note: The battery is in the engine compartment.



Do not disconnect the terminal at the 12mm nut.



Use 10mm socket.

- Remove the NEGATIVE (-) battery terminal by loosening the 10mm terminal nut before starting any disassembly. See Figure 1.
- Optional Step: Place insulator over negative battery terminal.



**DO NOT touch the positive terminal.**





**Wait at least 90 seconds after disconnecting the cable from the negative (-) battery terminal to disable the SRS system.**



**Figure 2**

### VEHICLE DISASSEMBLY- INSTALLATION PROCESS

- 
 Apply masking tape to the center console's surface along the edge of the rear console end panel to protect pry points. See Figure 2.
- 
 Use a moulding remover tool to avoid damaging the part.
- 
 Place a protective blanket in the rear passenger area.

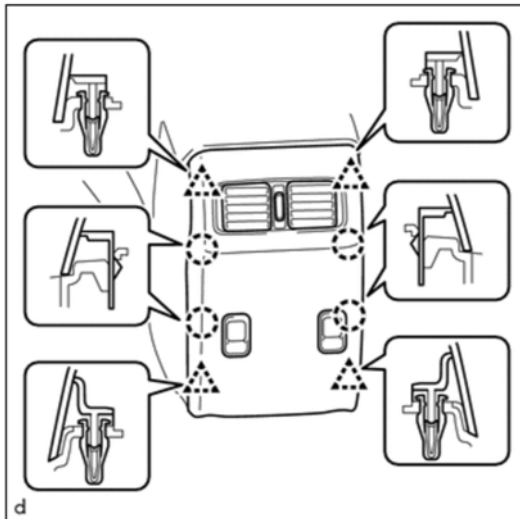

**Figure 3**

### 3. REMOVE REAR CONSOLE END PANEL

- a. Disengage the 4 claws and the (4) clips to remove the rear console end panel.
- b. Disconnect the (2) power outlet socket assembly connectors. See Figure 3.

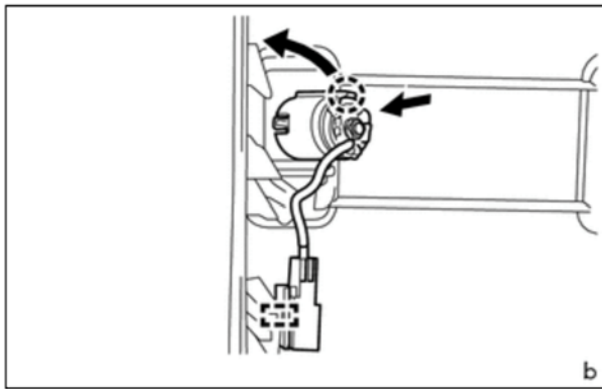

**Figure 4**



**Perform these steps on a padded surface to avoid damaging the part.**

4. Orient the rear console end panel as shown in the illustration.
5. The No. 3 power outlet socket assembly is circled and will be removed. See Figure 4.



**Figure 5**

6. REMOVE NO. 3 POWER OUTLET SOCKET ASSEMBLY
  - a. Detach the connector clamp.
  - b. While pulling the claw of the No. 3 power outlet socket assembly in the direction of the arrow, push the No. 3 socket assembly toward the inside of the chamber to remove it. See Figure 5.





*Figure 6*



*Figure 7*

**OPTIONAL STEP: Use a cigarette lighter adapter (CLA) removal tool.**

7. Insert one side of the "T" end of the CLA Removal Tool into the tab window & then the other should be angled into the opposite window. See Figure 6.

**Hint: Twist Counter Clockwise.**

8. Detach the claw and guide to remove the power outlet socket assembly using the CLA Removal Tool.

9. Pull the socket assembly straight out from the power outlet socket cover. See Figure 7.

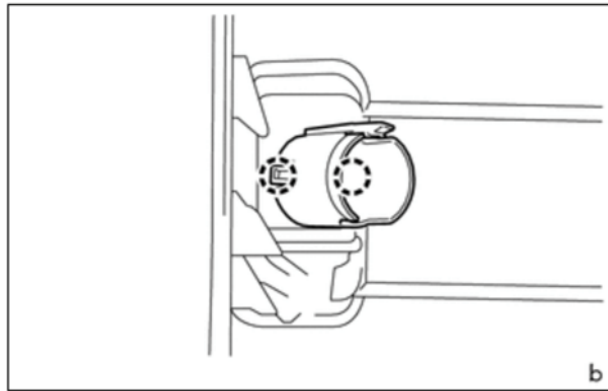

*figure 8*

10. REMOVE POWER OUTLET SOCKET COVER

(a) Detach the 2 claws to remove the power outlet socket cover. See Figure 8.



*Figure 9*

11. The No. 3 power outlet socket assembly is removed from the rear console end panel leaving the hole circled in the illustration. See Figure 9.



**Figure 10**



Use a deburring tool to enlarge the No. 3 power outlet's hole. See Figure 10.



**Figure 11**

- Using the deburring tool, carefully make two passes on the outside of the No. 3 power outlet's hole to remove ~1mm of material to enlarge the RH side of the hole. See Figure 11.



*Figure 12*

### USB POWER PORT INSTALLATION:



Perform these steps on a padded surface to avoid damaging the part.

13. Orient the rear console end panel so that the outside surface is facing you.
14. Unscrew nut and remove lock washer then feed the power and ground wires through the power outlet hole from the outside of the rear console end panel. See Figure 12.



*Figure 13*

15. Feed the power and ground wires through the lock washer and nut. The lock washer goes on first. See Figure 13.



The lock washer has no up or down side; it can be installed in either direction.



**Figure 14**



**Align the flat, horizontal surface (where the power and ground wires exit) at the end of the USB Power Port with the horizontal lines of the rear console end panel.**

16. Hand-tighten the nut until snug. See Figure 14.

**T-TAP INSTALLATION**

When installing the female T-Tap connectors, be sure the wire is located inside the wire channel of the female T-Tap connector before closing the connector over the wire with pliers.

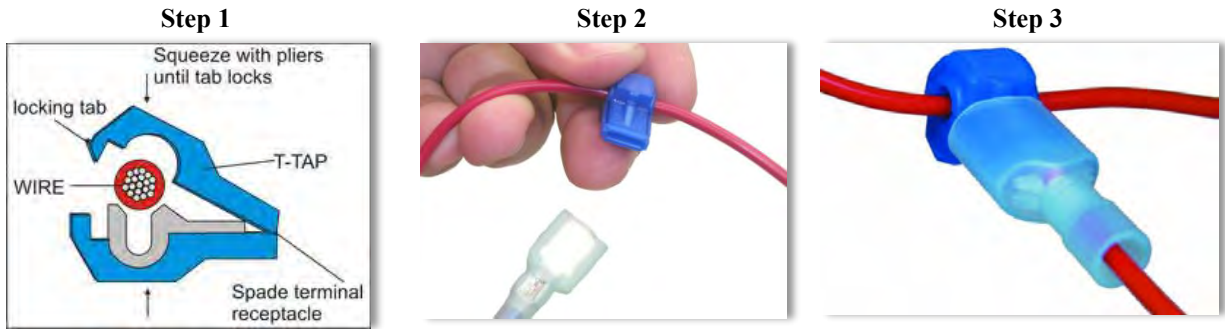

Note: Pictures above are examples only on how to install T-Taps (Red or Blue)

**CONNECTOR M4: No. 3 Power Outlet Socket Assembly)**

Location: RH side rear console end panel

No. 3 Power Outlet Socket Assembly M4 White

USB POWER PORT	VEHICLE	PIN	T-TAP
Black - Ground	White/Black	1	Red
Red - Power	Light Green	2	Red

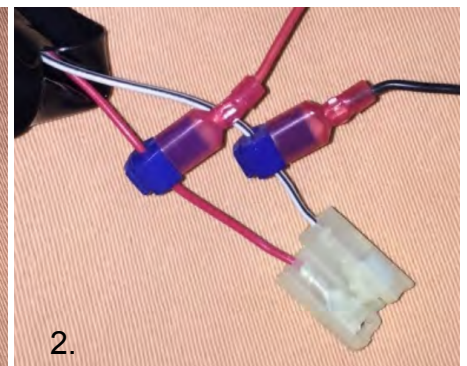
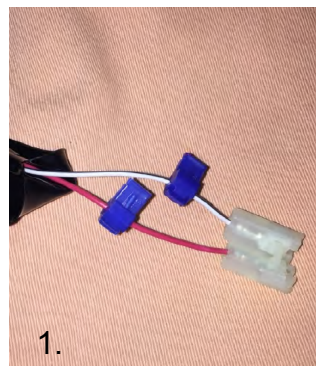
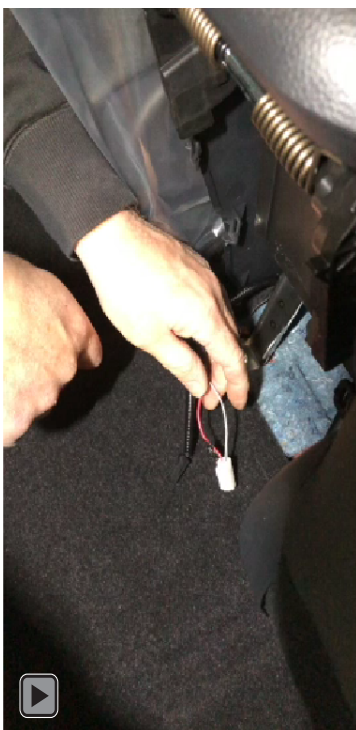
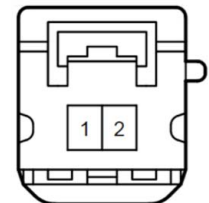

Examples

**Note :** Install the T-Taps in a staggered position on the wires. T-Taps should not be side by side nor same distance from the connector. There should be approximately at least one inch of wire remaining between the connector and the closest t-tap to the connector. See Examples 1 & 2.

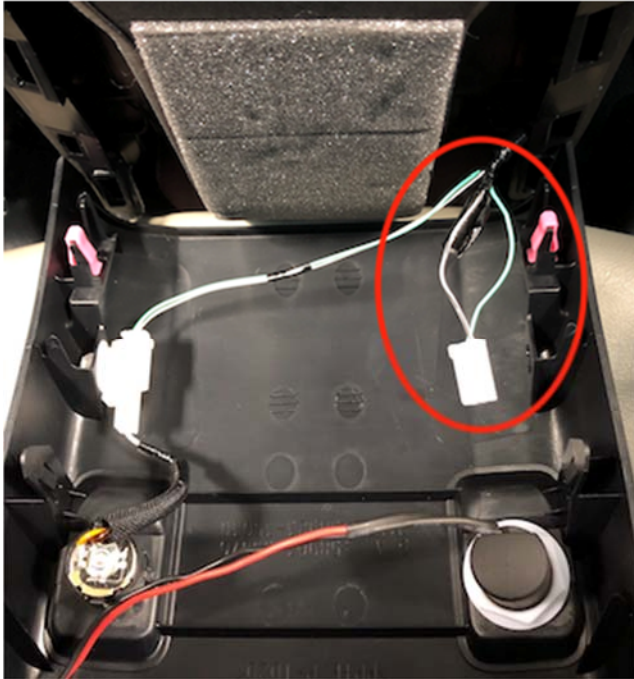
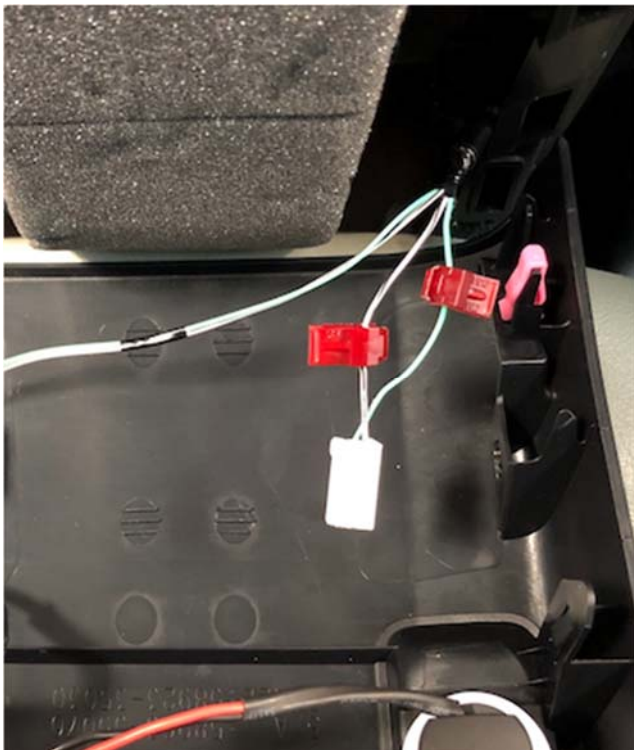

*Figure 15*

17. Place the rear console end panel loosely in position in the rear passenger area.
18. Locate the white, rear power outlet socket M4 (2 pin) connector at the RH side of the center console box.
19. Pull back the protective tape, if necessary, to expose at least 2" of the power & ground wires behind the connector on the vehicle side.
20. Separate the LIGHT GREEN power wire from the WHITE/BLACK ground wire. Figure 15.



**Hold the exposed wires when pulling back the protective tape. Do not pull the wires from the connector.**



*Figure 16*

21. T-Tap the LIGHT GREEN power wire (Pin 2) & the WHITE/BLACK ground wire (Pin 1) from connector M4 using the supplied RED #951 T-Tap female connectors. Figure 16.



**Stagger the T-tap connectors as shown.**



*Figure 17*



Before connecting, make sure the USB Power Port's male spade connectors are not bent to one side to ensure they insert securely into their corresponding female T-Tap connectors.



Do not reverse the power & ground connections or the USB Power Port will not function.

22. Connect the male spade connector of the USB Power Port's RED power wire to the M4 connector's LIGHT GREEN power wire T-tap (Pin 2).
23. Connect the male spade connector of the USB Power Port's BLACK ground wire to the M4 connector's WHITE/BLACK ground wire T-tap (Pin 1). See Figure 17.

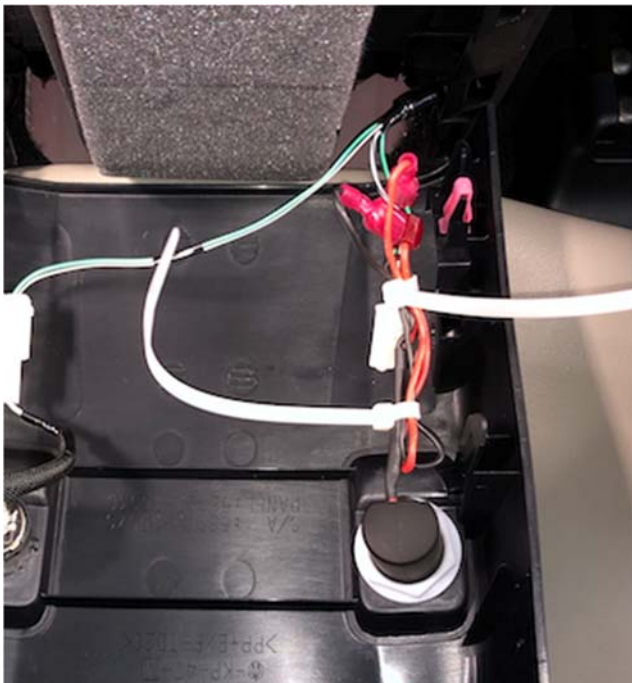

*Figure 18*



Use two (2) 8" zip ties.

24. Bundle the USB Power Port's power & ground wires to remove most of the slack.
25. Secure the power & ground wire bundle with the supplied 8" zip ties to the factory power outlet wire harness as shown. See Figure 18.
26. Snip the excess zip tie lengths.



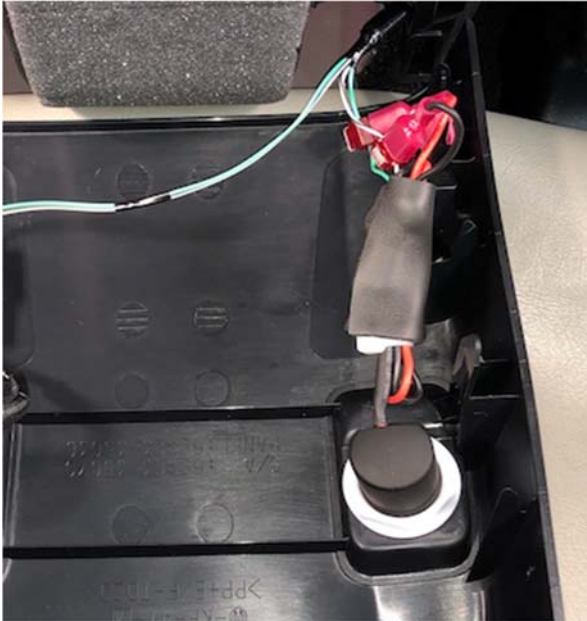
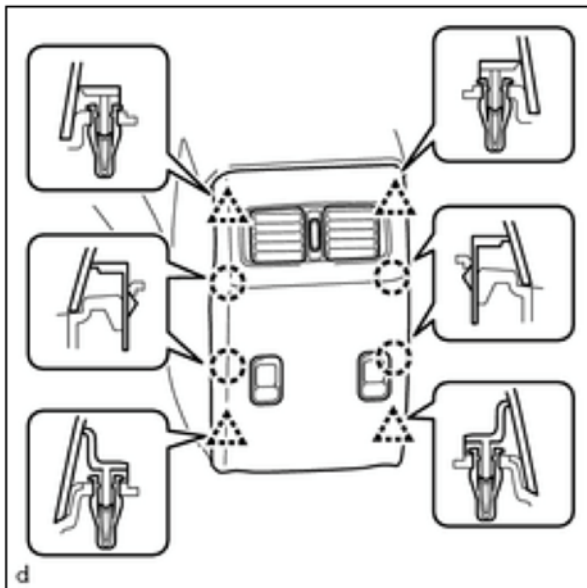

**Figure 19**



Use one (1) 2"x 2" foam tape square.

27. Wrap the secured bundle with one (1) foam tape square as shown in the illustration. See Figure 19.



**Figure 20**

### VEHICLE REASSEMBLY

#### 28. INSTALL REAR CONSOLE END PANEL

- a. Connect the remaining power outlet socket assembly connector.
- b. Engage the 4 claws and the 4 clips to install the rear console end panel. See Figure 20.



Figure 21

29. USB Installed. See Figure 21.

**RE-INSTALL BATTERY**



Figure 22



Use 10mm socket & torque wrench.

30. Reconnect the negative battery cable. Figure 22.



Torque: 48 in•lbs



Caution: DO NOT touch the positive terminal.



When disconnecting the cable, some systems need to be initialized after the cable is reconnected.

31. Print Warranty Statement and place in the glove box, DIO only.

**FUNCTION AND QUALITY CHECK**

CHECKLIST - these points MUST be checked to ensure a quality installation.

**ACCESSORY FUNCTION CHECK:****LOOK FOR:**

 Alignment

USB power ports are aligned Vertically.

 Turn ignition (ACC power) to On.

LED power status light is on.  
Both USB power ports supply power.  
Remaining factory power outlet supplies power.

 Warranty Statement

Place Warranty Statement in the glove box,  
DIO Only.

**DIAGNOSTIC / BLOCK DIAGRAMS & CONNECTOR PROCEDURES**

**EWD - Block Diagram**  
**Dual USB Power Port**  
**Part Number: 00016-00325**  
Parasitic Draw = 2.0mA Max Power Draw = 24W

Connects to  
ACC circuit  
@ M4 pin 1

Connects to  
ACC circuit  
@ M4 pin 2

**C2**

**C1**

**B**

**R**

**USB Power Port**  
**Part Number: 00016-00325**

5V/2.4A

5V/2.4A

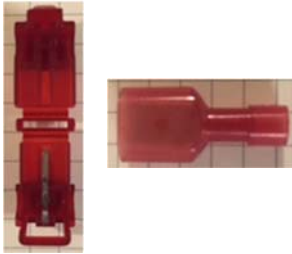

**Connector C1**

Pin	Wire Color	Test Reference	Proper Operation
1	Red	Pin 1 to Ground	Approximately 0 VDC when ignition switch is OFF +12 VDC when ignition switch is ON

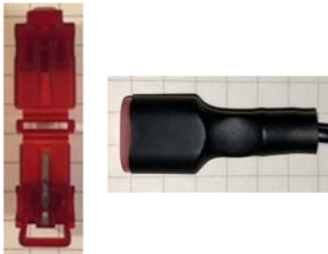

**Connector C2**

Pin	Wire Color	Test Reference	Proper Operation
1	Black	Pin 1 to Ground	Approximately 0 VDC



## LIMITED WARRANTY – SOUTHEAST TOYOTA

SOUTHEAST TOYOTA DISTRIBUTORS, LLC (“we,” “our” and “us”) provides the following limited warranty on our accessories, excluding tires, (“Accessories” or “Accessory”) installed on a Toyota. This limited warranty is not provided by and does not bind or provide benefit to the vehicle dealer, the manufacturer, or Toyota Motor Sales, U.S.A., Inc. This limited warranty does not apply to tires; please consult the tire manufacturer and/or its materials accompanying the vehicle for any warranty terms concerning tires. This limited warranty also does not apply to ToyoGuard Exterior Paint Sealant and ToyoGuard Interior Protector; please consult the ToyoGuard Limited Warranty Certificate for the warranty terms concerning those products.

### SCOPE OF LIMITED WARRANTY:

#### A. Protection:

- i. **Accessories Installed by Southeast Toyota Distributors, LLC on a new Toyota vehicle.** We warrant that, for a period of 36 months or 36,000 miles, whichever occurs first, we will repair or replace (includes labor), free of charge, any defect in such an Accessory due to faulty material or workmanship, or, at our option, provide a full refund of the purchase price of the Accessory. The warranty period begins on the vehicle’s In-Service Date, which is the first date the new vehicle is either delivered to an ultimate purchaser, leased, or used as a company car or demonstrator. Accessories installed by Southeast Toyota Distributors, LLC are identified on the vehicle’s window sticker (Monroney Label).
- ii. **Accessories Installed by a Toyota Dealer on a Toyota vehicle.** We warrant that, for 12 months, regardless of mileage, from the date such an Accessory was installed on the vehicle or the remainder of the Toyota new vehicle warranty, whichever is longer, we will repair or replace (includes labor), free of charge, any defect in the Accessory due to faulty material or workmanship, or, at our option, provide a full refund of the purchase price of the Accessory. For a new vehicle, the warranty period begins on the vehicle’s In-Service Date, which is the first date the new vehicle is either delivered to an ultimate purchaser, leased, or used as a company car or demonstrator.
- iii. **Accessories purchased from a Toyota Dealer but not installed by the Toyota Dealer.** We warrant that, for a period of 12 months, regardless of mileage, from the date the accessory was purchased, we will repair or replace (does not include labor), free of charge, any defect in the Accessory due to faulty material or workmanship, or, at our option, provide a full refund of the purchase price of the Accessory.

**B. Limitation of Warranty.** This limited warranty does not apply to, and we will not repair, replace, or reimburse you for: (1) wheel balancing and wheel alignments, except for one wheel balancing or alignment during the first 12 months or 12,000 miles, whichever occurs first, from the vehicle’s In-Service Date, as defined above, (2) abrasions or dents, whatever their cause, and any failure or damage resulting directly or indirectly from accidents, collisions, impacts from foreign objects, fire, theft, larceny, explosion, malicious mischief, vandalism, civil commotion, riots, war, or any other similar causes, (3) any failure or damage resulting directly or indirectly from lightning, windstorms, hail, water, floods, subfreezing temperatures, airborne chemicals, tree sap, dust, salt, and any other environmental conditions or similar causes, (4) any failure or damage caused by: (a) a failure of any part, other than the Accessory, (b) any misuse, abuse, improper towing, negligence or lack of maintenance of the vehicle or Accessory, (c) the alteration, modification or repair of the Accessory by anyone other than persons expressly authorized by us to perform such alteration, modification or repair, or (d) the use of the vehicle for commercial purposes, competitive driving or racing, (5) any failure or damage, if the Accessory has not been installed according to instructions, (6) any failure or damage occurring outside of Canada, the United States of America, its territories or possessions, (7) except to the extent required by the state whose laws govern this limited warranty, any consequential, secondary, or unreasonable costs that may be suffered as a result of the need to repair or replace the Accessory, including without limitation any loss of use of the vehicle, road service, towing, storage charges, inconvenience, loss of wages and/or income, additional expense incurred, loss of transportation, rental car expense, or any derivative damage to persons or things other than the Accessory, including other parts of the vehicle, or (8) liability for damage to property or for injury to or death of any person, arising out of the operation, maintenance or use of your vehicle whether or not related to the covered Accessory.

**C. Exclusive Remedy.** If there is a valid claim under this limited warranty for a defect due to faulty material or workmanship in the Accessory, we will, at our option, either: (i) repair, (ii) replace or (iii) provide a full refund of the purchase price of the Accessory. We have no other obligations under this limited warranty. Refunds will be made to the vehicle owner. If the vehicle is leased, the refund will be made to the leasing company.

**HOW TO MAKE A CLAIM:** In the event of a warranty claim, please contact the nearest Toyota dealer to arrange for repairs. The dealership must receive our prior authorization before making repairs covered by this limited warranty. The dealer will contact Southeast Toyota Distributors, LLC at 1-888-851-2722, select option #5 (Warranty Department), then option #4 (Repairs), for instructions on processing a warranty claim, if they are not already familiar with the process. If you have any questions or concerns regarding repairs covered by this limited warranty, please contact our **Customer Assistance Hotline at 1-800-301-6859**.

**OUR DISPUTE RESOLUTION PROGRAM:** Your satisfaction is our highest priority. In keeping with that focus, in the event that an issue arises related to this Limited Warranty, we invite you to call our Customer Assistance Hotline at 1-800-301-6859 to discuss it. In most cases, we expect that a satisfactory resolution of your issue can be reached through engagement with that Department. If our Customer Loyalty Department is unable to resolve your issue to your satisfaction, we offer a dispute resolution program administered by the National Center for Dispute Settlement (NCDS) (“the Program”). The purpose of the Program is to resolve disputes in an informal setting before an impartial arbitrator. The Program is free of charge to you (although you must bear the cost of any expert witness or attorney you elect to employ). You are required to complete the Program before exercising rights or seeking remedies under the federal Magnuson-Moss Warranty Act, 15 U.S.C. § 2301 et seq. (“the Act”). If you choose to seek remedies that are not created by the Act, you are not required to use the Program before pursuing such remedies – although the Program is still available to you to resolve the dispute. When utilizing the Program, you will need to provide (a) the vehicle identification number of your vehicle, (b) the identity of your selling and servicing dealerships, (c) the mileage on your vehicle at relevant times, (d) the date and nature of any relevant repairs, (e) legible copies of repair orders and other relevant documents, (f) a summary of the unresolved issue and the requested action, and (g) your contact information. In most cases, the dispute resolution process under the Program will be completed within forty (40) days of your submission of your request and will consist of steps such as an initial eligibility determination, an opportunity for you and us to submit information in writing relating to your claim, an oral hearing, and a decision from the arbitrator. A decision will be binding on you only if you choose to accept it. You may submit a request to NCDS by telephone at their toll free number: (877)-276-8848 or in writing at P.O. Box 463196, Mt. Clemens, MI 48046. You may obtain additional information regarding the Program at [www.ncdsusa.org](http://www.ncdsusa.org). In the event that the NCDS does not exist or no longer handles disputes for us at the time that you seek to submit a request, you may contact our **Customer Assistance Hotline at 1-800-301-6859** to obtain current information about our dispute resolution programs.

**GENERAL LIMITATION OF WARRANTY:** THIS LIMITED WARRANTY IS IN LIEU OF ALL OTHER EXPRESS WARRANTIES OR LIABILITIES. IN NO EVENT SHALL WE BE LIABLE FOR ANY CONSEQUENTIAL OR INCIDENTAL DAMAGES FOR BREACH OF THIS OR ANY OTHER WARRANTY. SOME STATES DO NOT ALLOW THE EXCLUSIONS OR LIMITATIONS OF INCIDENTAL OR CONSEQUENTIAL DAMAGES, SO THE ABOVE INFORMATION OR EXCLUSION MAY NOT APPLY. NO EXPRESS WARRANTY OF FITNESS OR MERCHANTABILITY IS GRANTED BY THIS LIMITED WARRANTY. THERE ARE NO WARRANTIES WHICH EXTEND BEYOND THOSE DESCRIBED IN THIS DOCUMENT. ANY IMPLIED WARRANTIES, INCLUDING THE IMPLIED WARRANTY OF MERCHANTABILITY OR FITNESS FOR A PARTICULAR PURPOSE, WHICH MAY BE APPLICABLE BY OPERATION OF LAW SHALL BE LIMITED TO THE PERIOD OF THIS WRITTEN LIMITED WARRANTY. SOME STATES DO NOT ALLOW LIMITATIONS ON HOW LONG AN IMPLIED WARRANTY LASTS, SO THE ABOVE LIMITATIONS MAY NOT APPLY. THIS LIMITED WARRANTY PROVIDES SPECIFIC LEGAL RIGHTS, AND THERE MAY BE OTHER RIGHTS WHICH VARY FROM STATE TO STATE. ANY ACTION FOR BREACH OF ANY WARRANTY HEREUNDER, INCLUDING ANY IMPLIED WARRANTY OF MERCHANTABILITY, MUST BE BROUGHT WITHIN A PERIOD NOT EXCEEDING 12 MONTHS AFTER EXPIRATION OF THIS LIMITED WARRANTY. THE REMEDIES SPECIFIED HEREIN AND THOSE SPECIFIED BY APPLICABLE LAW ARE THE ONLY REMEDIES AVAILABLE. WE ASSUME NO OTHER OBLIGATION OR RESPONSIBILITY WITH REGARD TO THE ACCESSORY. WE NEITHER ASSUME, NOR AUTHORIZE ANYONE TO ASSUME FOR US, ANY ADDITIONAL LIABILITY IN CONNECTION HERewith.

**GENERAL:** This limited warranty describes the complete and exclusive rights that result from the purchase of Accessories. No oral representations or statements may be relied upon. This limited warranty may not be amended or modified, and additional rights may not be granted, unless in a written statement signed by one of our officers. This limited warranty shall be governed by the laws of the state where the vehicle is purchased, excluding laws concerning conflicts of law. We may delegate the performance of our duties and obligations and assign our rights and benefits hereunder. For inquiries regarding this limited warranty, we can be contacted directly at **Customer Assistance Hotline at 1-800-301-6859**, or by mail to: **Southeast Toyota Distributors, LLC, Attention: Customer Loyalty Department, 100 Jim Moran Boulevard, Deerfield Beach, Florida 33442.**