



A. Check Kit Contents

1. Check kit for content and damage. (Fig. A1)

B. Vehicle Preparation

-  1. Remove battery negative terminal.
- 2. Apply protective covering to vehicle.
-  3. Set parking brake.

C. Remove center console

1. Remove cup insert.
 - i.. Grasp Cup holder insert and lift upward, and remove from vehicle. (Fig. C1)
 -  ii. Use panel safe tool.
 - iii. At rear edge of center console insert pry upward. Remove parking brake insert. (Fig. C2)
 - iv. Lift rear of center console and slide towards rear. Remove from vehicle. (Fig. C3)

BUCKET SEAT

2. Loosen front kick panel fasteners.
 - i. Using a phillips screwdriver loosen fastener while pulling outward. Remove fasteners on both sides. (Fig C4ab)

BENCH SEAT

3. Remove center console screws
 - i. Using phillips screwdriver remove screws as shown. (Fig. C5ab)
 - ii. Pull forward to allow access to rear of cigarette lighter.

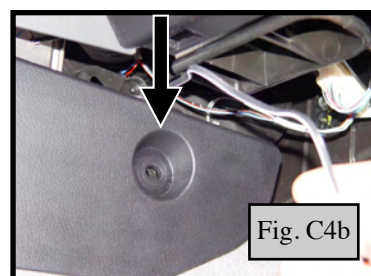
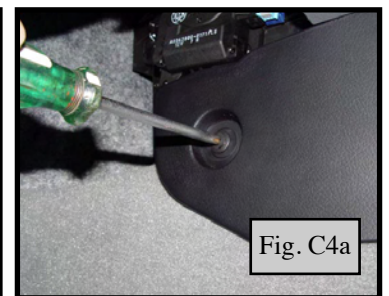

D. Install Harness

Caution: Secure harness with pads and cable ties as needed, keep harness from touching hot or moving objects.

1. Lay out harness as shown and identify connectors. (Fig. D1)

PW	Power
SW	Switch
LED	Module
CH	Cup Holder
SB	Storage Box

2. Bulk of harness will reside under forward portion on center console beside shift assembly in floor shifter model.
3. Route storage box connector to the rear of the center console.
 - i. Secure as needed.
4. Route LED connector to driver side of center console as shown.
5. Route LED connector to passenger side of vehicle.
6. Locate power.
 - i. Locate Power outlet socket located in cargo box White with Black stripe negative, Gray positive.

- ii. Install T-Taps in a staggered fashion. (Fig. D3ab)

Bench Seat

1. Lay out harness as shown & identify connectors. (Fig. D2)
2. Bulk of harness will reside behind center console facia.
3. Attach harness to power. (Fig. D4)

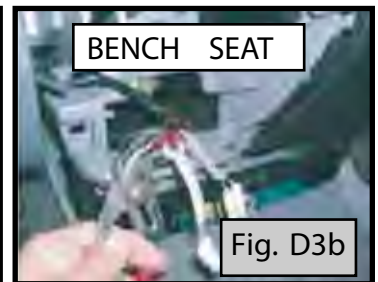
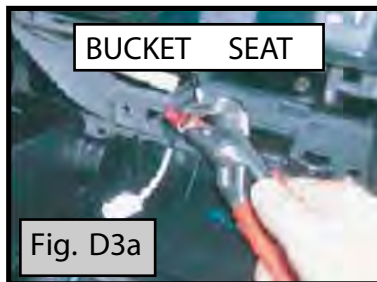
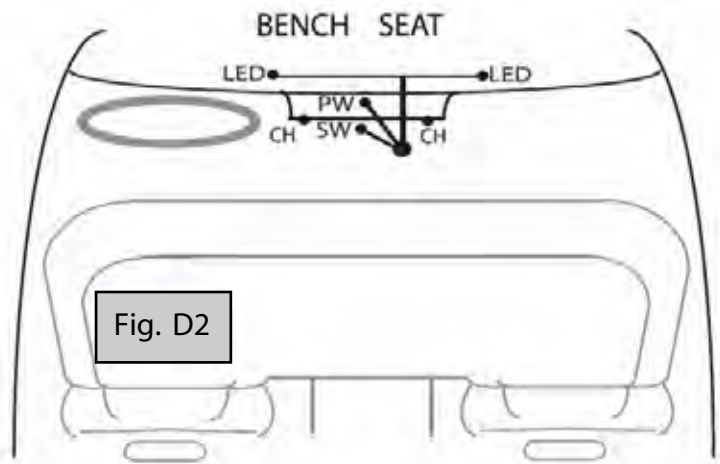
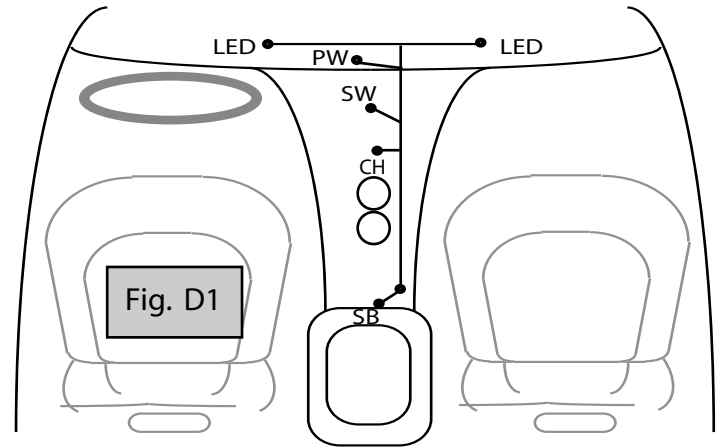

Attach Red T-Taps to gray wire (Pin# 1) and the White wire with the Black Strip (Pin# 2) on connector H17 of the cigarette lighter circuit with pliers

E. Install Storage Box Lights

BUCKET SEATS

1. Drill holes for storage box lights. Final installation should look as shown. (Fig. E1)
 - i. Cut out enclosed paper template labeled “passenger side bucket seat storage box”.
 - ii. Align template as shown use a punch/scribe to mark the center of the hole to be drilled. (Fig. E2)
 - iii. Drill pilot holes with 1/8” drill bit. (Fig. E3)
 - iv. Finally drill hole with a 9/32” drill bit.
 - v. De-burr holes with de-burring tool.
 - vi. Repeat using template labeled “drivers side bucket seat storage box” (Fig E4)
2. Insert Lens from inside of storage box. (Fig. E5)
3. Firmly press LED assembly into lens. (Fig. E6)
4. Use adhesive pad to secure wires. (Fig. E7)

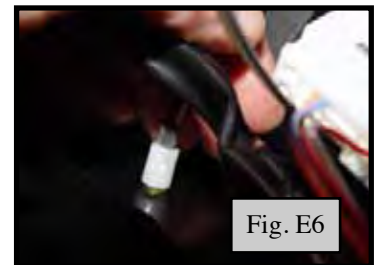
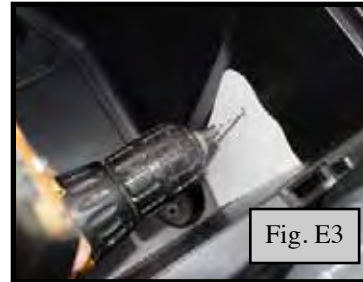
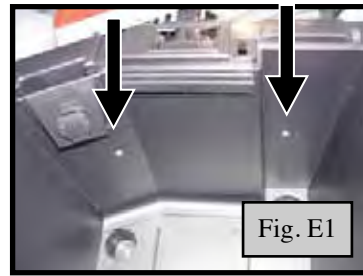

F Install Cup Holder Lights.

BUCKET SEATS

1. Drill holes for cup holder lights
 - i. Cut out “Bucket seat cup holder templates”
 - ii. Align template as shown using edge of casting for alignment. (Fig. F1ab)
 - iii. Use a punch/scribe to mark the center of the hole to be drilled.
 - iv. Drill pilot holes with 1/8” drill bit.

Allow drill bit to penetrate cup holder liner to help align holes.

 - v. Drill the lamp hole with a 9/32” drill bit.
 - vi. De-burr holes with de-burring tool.
2. Insert lens from inside of cup holder box.



REAR

FRONT

Section II - installation procedure

3. From the outside of the cup holder install the LED's onto the lenses. Press firmly while holding the lens from the outside. (Fig. F3ab)
4. Use adhesive pad to secure wires. (Fig. F4)
5. Connect to cup holder "Y" lead on harness.
6. Reinstall center console.
7. Using previously drilled hole as a guide, drill a 3/8" hole in the cup holder insert to allow light to pass through. A Unibit or step drill is recommended. (Fig. F5ab)
8. Reinstall cup holder insert.

BENCH SEATS

1. Remove cup holder assembly
 - i. Depress small tab on both sides of sliding cup holder assembly. (Fig. F6)
 - ii. Remove cup holder assembly and orient as shown. (Fig. F7)
2. Drill holes for cup holder lights
 - i. Cut out "bench seat cup holder templates"
 - ii. Align template as shown using edge of casting for alignment. (Fig. F7)
 - iii. Use punch/scribe to mark center of the hole to be drilled.
 - iv. Drill pilot holes with 1/8" drill bit. (Fig. E3)
 - v. Drill lamp hole with a 9/32" drill bit.

3. Insert lens from inside of cup holder box. (Fig. F8)
4. From the outside of the , install the LED's into the lenses. Press firmly while holding the lens from the inside. (Fig. F9)
5. Drill hole on tab on cup holder and secure the lamp assemblies wire harness to act as a strain relief. (Fig. F9)
6. Use adhesive pad to secure wires. (Fig. F10)



Fig. F3a



Fig. F3b

FRONT

REAR

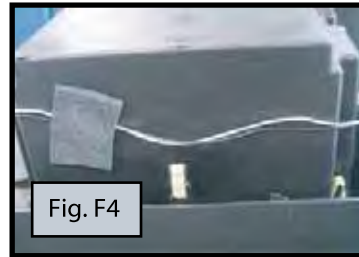

Fig. F4

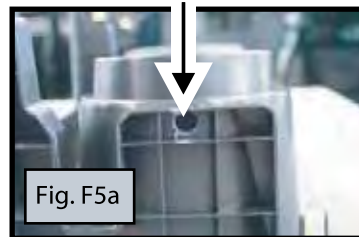

Fig. F5a

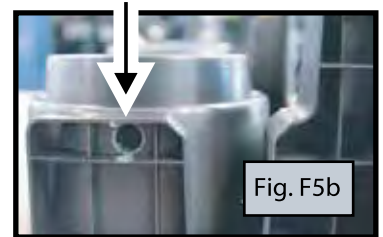

Fig. F5b

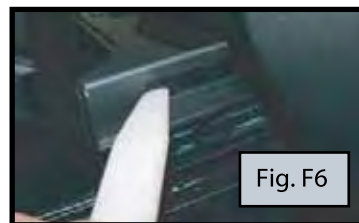

Fig. F6



Fig. F7



Fig. F8

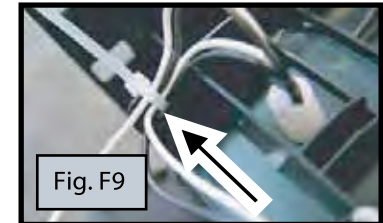

Fig. F9

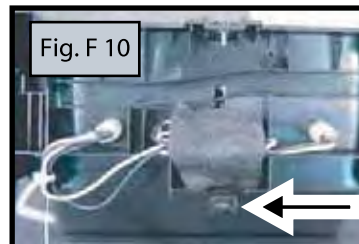

Fig. F10

DO NOT COVER TAB

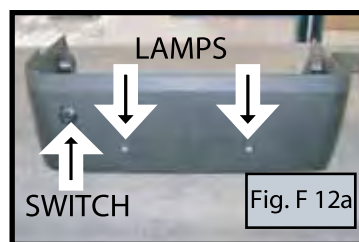

Fig. F12a

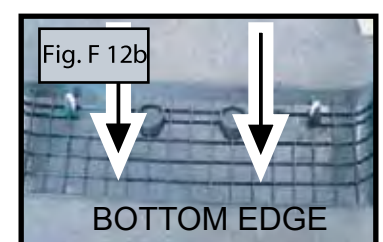

Fig. F12b

BOTTOM EDGE

**INSTALL ADDITIONAL LIGHTS
BENCH SEATS**

1. Using photos locate where Lamps are to be placed . (Fig. F12ab)
 - i. Use a punch/scribe to mark the center of the hole to be drilled.
 - ii. Drill pilot holes with 1/8” drill bit.
 - iii. Drill the lamp hole with a 9/32” drill bit. (Fig. 13ab)
2. Insert lens from front of facia.
3. From the outside of the cup holder, install the LED’s onto the lenses. Press firmly while holding the Lens from the inside. (Fig. F14ab)

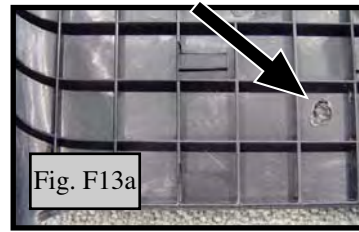

Fig. F13a

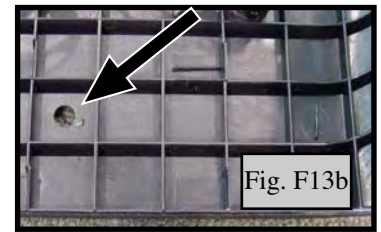

Fig. F13b



Fig. F14a

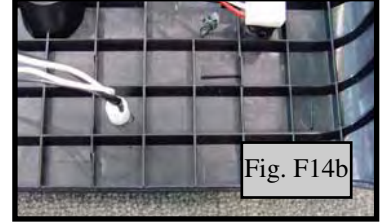

Fig. F14b

G. Install Light Modules

1. Install Driver side Light Module.
2. Locate attachment location as indicated. (Fig. G1-G2)
3. Clean surface to remove and wax.
 - i. Wipe application area clean with alcohol and a clean no-scratch cloth.(Fig. G3)
 - ii. Dry the installation area using a clean, dry, lint free cloth.
4. Using the pull tab remove the tape liner from the back of the switch plate. (Fig. G4)
 - i. Avoid finger contact with the adhesive surface.
 - ii. Press module firmly against surface.
5. Secure module with screws. (Fig. G5)
6. Install passenger side Light Module.
7. Remove passenger side shield by pressing in four tabs located along front edge of shield.
8. Locate attachment location as indicated. (Fig. G6)
9. Thread Light Module lead through shield. (Fig. G6)
10. Repeat steps G3 through G5.



Fig. G1

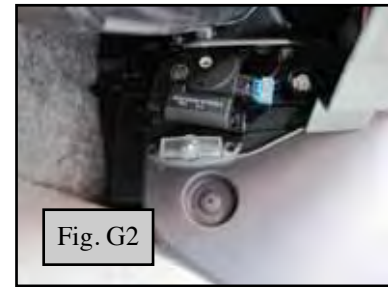

Fig. G2



Fig. G3



Fig. G4



Fig. G5

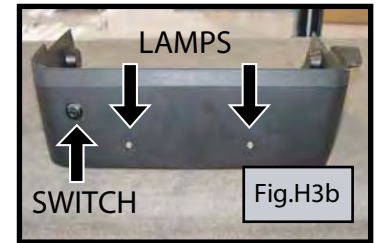
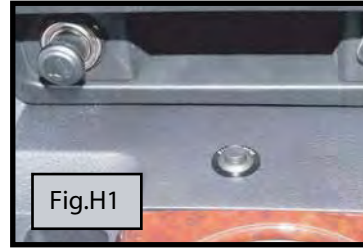

Fig. G6

H. Install power switch

BUCKET SEATS

1. Final switch orientation. (Fig.H1)
2. Drill hole for switch.
 - i. Cut out “Bucket seat template”
 - ii. Align template as shown using edge of casting for alignment. (Fig.H2)
 - iii. Use punch or scribe to mark center of the hole to be drilled.
 - iv. Using a 1/2” drill bit (Unibit or step drill is highly recommended), drill the switch hole.



BENCH SEATS

1. Final switch orientation. (Fig. H3ab)
2. Center switch hole between ribs. (Fig. H4)
3. Clean bezel surface to remove grease and wax.
 - i. Wipe the application area clean with alcohol and a clean no-scratch cloth.
 - ii. Dry the installation area using a clean, dry, lint free cloth.
4. Insert switch bezel into switch plate. (Fig. H5)
5. Using the pull-tab, remove the tape liner from the back of the switch plate. (Fig. H3)
 - i. Avoid finger contact with the adhesive surface.
6. Using the bezel as a guide, install switch plate/bezel into the previously drilled 1/2” hole.
 - i. Align the printing “ILLUMINATION” square to the console. (Fig. H4)
 - ii. Once aligned, press down firmly to adhere tape.
7. Install Sleeve to bezel, white edge of sleeve goes towards console. (Fig. H7)

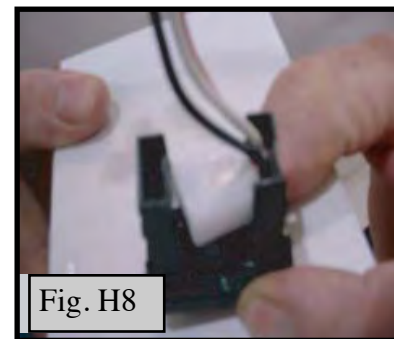
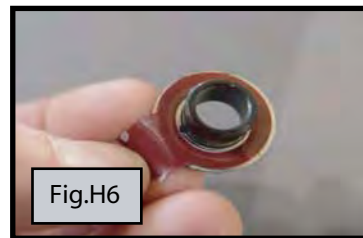
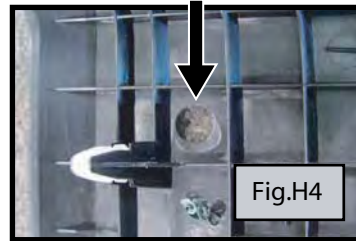

NOTE: BENCH SEAT 5.7L

Locate left knock out below heater control and mount switch in knock out and reinstall knock out. (Fig. H8)

8. Install switch to bezel as shown.
 - i. Using switch tool turn bezel clockwise to tighten.
 - ii. Be careful not to over tighten as this will “over ride” the threads on the switch. If this happens simply retighten being careful not to over tighten.
 - iii. Push button into bezel pressing to engage. (Fig. I5)



I. Connect Switch to Harness

1. Connect switch leads to harness. (Fig. I1)
2. Bundle up any excess wires and secure with cable tie. (Fig. I2)

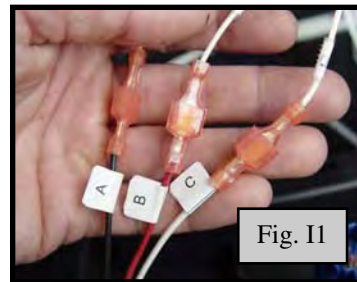

Fig. I1

J. Post Installation

1. Reinstall interior.
2. Re-attach negative battery terminal, torque to 36 inch pounds.
3. Clean LED modules with window cleaner and a non-scratch cloth.
- ▼ 4. Cycle test the system with the key in the ACC or ON position. The cycle may start from any step below but should cycle in this order.
 - i. All lights off.
 - ii. Cup holder lights on only.
 - iii. All lights on.
 - iv. Interior Light on only.
 - v. Back to step “i”.
5. The switch should be cycled to step “i” (all lights off) for shipment.
6. Place information card in glove box.

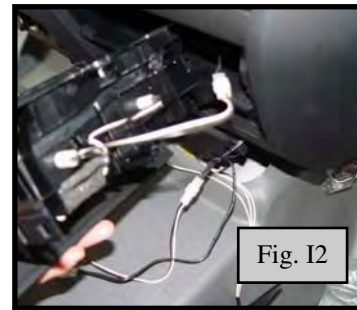

Fig. I2

Check:

Single UnoperationalModule

No OperationalModules

Look for:

Full engagement of affected LED module to LED wire harness pigtail connector.

Light guide inserted incorrectly (wrong end)

Full engagement of all LED module to LED wire harness pigtail connectors.

Power connection.

Ground connection

Switch connections

Blown light kit fuse. (2 amp located under center console)

Blown shift console illumination fuse (see vehicle owners manual for amperage and location.).

VEHICLE FUNCTION CHECK

AFTER ALL PANELS, COVERS, AND COMPONENTS HAVE BEEN REINSTALLED, THAT WERE REMOVED, TEST THOROUGHLY, ALL MECHANICAL AND ELECTRICAL COMPONENTS DISCONNECTED AND OR REMOVED FROM THE VEHICLE DURING THE INSTALLATION OF THIS ACCESSORY.

TOP

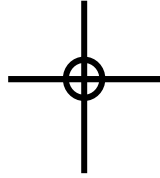

Drivers side storage box

FLUSH TO BOTTOM OF BOX

TOP

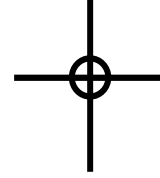

Passenger side storage box

FLUSH TO BOTTOM OF BOX



2 INCHES

INSIDE

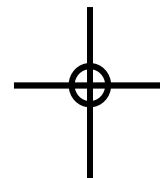

Switch

switch template

EDGE

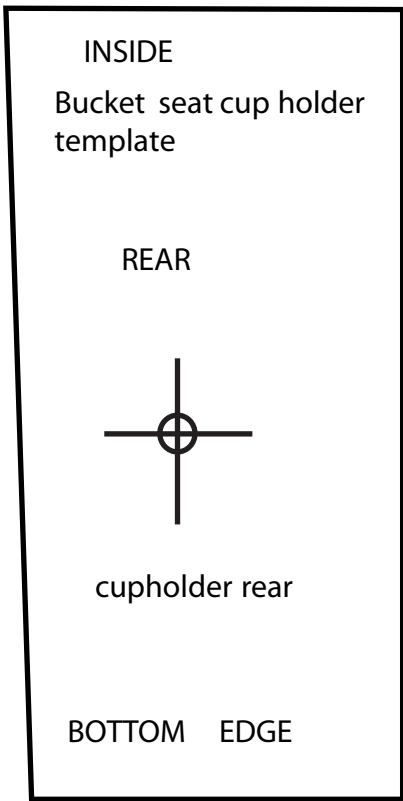

Bucket seat cup holder template

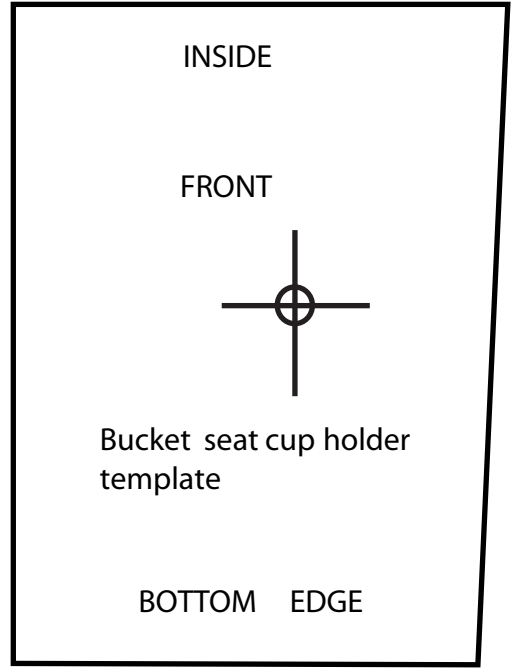

Bucket seat cup holder template



Bench seat cup holder template



Bench seat cup holder template

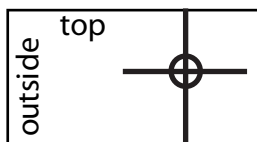

Bench seat cup holder template

