







A. Check kit for contents

1. Check kit of content and damage.
(Fig. A1)

B. Vehicle preparation

-  1. Disconnect battery negative terminal.
-  2. Apply protective covering to car.

C. Remove center console

1. Remove upper console garnish.
 - i. Use panel safe tool.
 -  ii. Carefully pry around lower edge of garnish. (Fig. C1)
 - iii. Firmly lift garnish straight up.
 - iv. Repeat on other side. (Fig. C2)
2. Remove upper console panel sub-assembly
 - i. Remove shift lever knob, turn counter clockwise. (Fig. C3)
 -  ii. Using panel safe tool, pry around edges of upper console panel. (Fig. C4)
 - iii. Disconnect connector. (Fig. C5)
3. Remove switch base.
 - i. Use panel safe tool.
 -  ii. Pry around lower corner of switch base. (Fig. C6)
 - iii. Disconnect connectors. (Fig. C7)
4. Remove console cup holder assembly.
 - i. Remove (2) screws. (Fig. C8)
 -  ii. Using panel safe tool pry up both forward edges and remove. (Fig. C9)

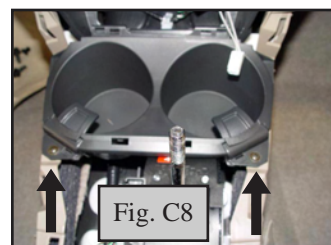
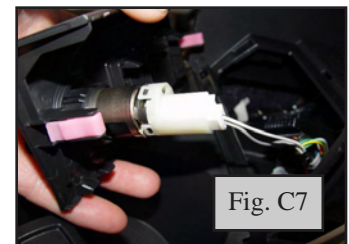
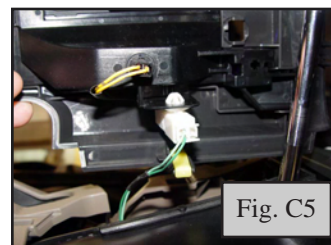

5. Remove upper rear console panel sub-assembly.

-  i. Using panel safe tool, Pry around edges of panel. (Fig. C10)
- ii. Disconnect connectors. (Fig. C11)

6. Remove console rear end panel.

-  i. Using panel safe tool, pry around edges and pull straight back. (Fig. C12)

7. Remove instrument panel bracket cover.

-  i. Using panel safe tool detach claws and remove. (Fig. C13)
- ii. Repeat for other side. (Fig. C14)

8. Remove console sub-assembly.

- i Remove console box liner. (Fig. C15)
- ii. Remove (2) screws. (Fig. C16)
- iii Remove (2) 10mm bolts. (Fig. C17)
- iv. Disconnect the connector and remove the rear console box. (Fig. C18)

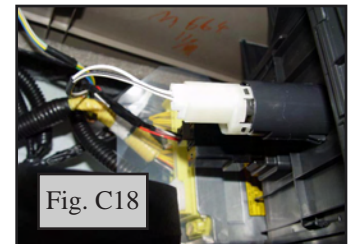
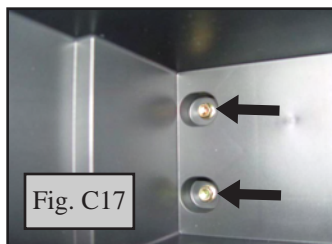
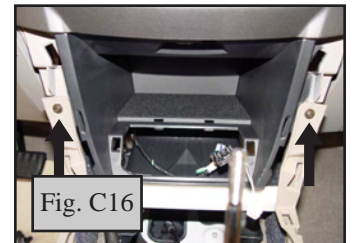
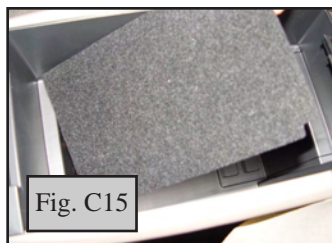
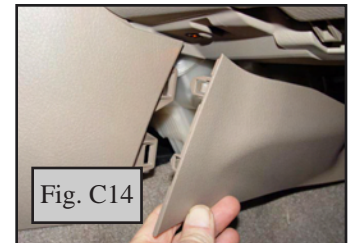

D. Install Storage box lighting

1. Un-snap and remove insert in storage box. (Fig. D1)
2. Cut out “Rav-4 storage box” template.
 - i. Align template as shown. (Fig. D2)
 - ii. Use a punch/scribe to mark the center of the holes to be drilled.
 - iii. Drill pilot holes with 1/8” drill bit.
 - iv. Drill the lamp hole with a 9/32” drill bit. (Fig. D3)
 - v. De-burr holes with de-burring tool.
3. Insert lens from inside of storage box. (Fig. D4)
4. Install the LED’s onto the lenses. Press firmly while holding the Lens from the inside. (Fig. D5)
5. Secure excess wire on passenger side with foam pad. (Fig. D5)
6. Reconnect connectors.
7. Re install console.
8. Re install (2) 10mm bolts. (Fig. D6)
9. Re-install console box liner. (Fig. D7)
10. Reinstall (2) screws. (Fig. D8)

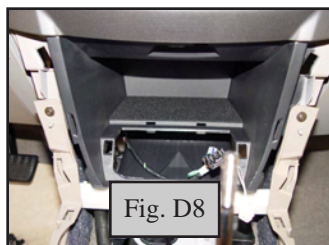
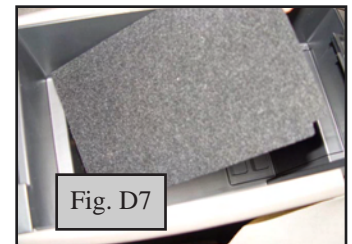
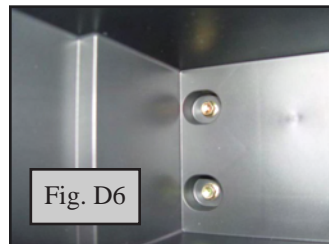
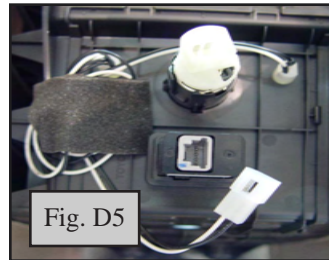
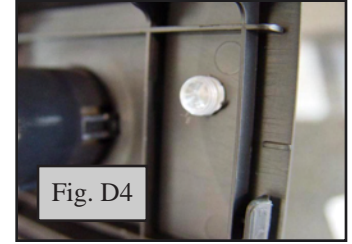
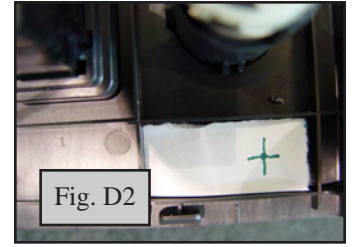
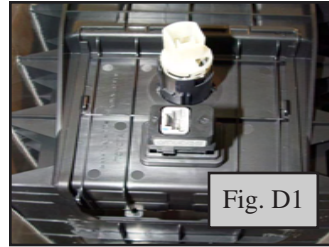

E. Install Cup Holder Lights

1. Cut out template labeled "cup holder".
2. Attach template to cup holder with adhesive tape.
 - i. Make sure LEDs are inserted from "flap side of cup holder"
 - ii. Use punch or scribe to mark where to drill. (Fig E1)
3. Drill Lamp hole.
 - i. Drill pilot holes with 1/8" drill bit.
 - ii. Drill the lamp hole with a letter "9/32" drill bit. (Fig. E2)
 - iii. De-burr holes with de-burring tool.
4. Insert lens from inside of cup holder. (Fig.E3)
5. Firmly press LED assembly into lens. (Fig.E4)
6. Use adhesive pad to secure wires. (Fig. E4)

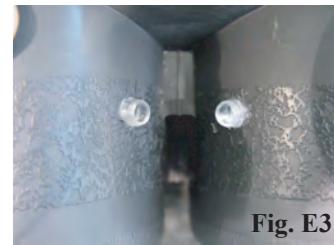
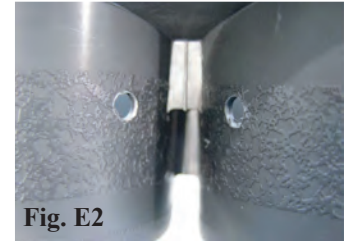

F. Locate Power

1. Locate leads going to front power outlet socket.
2. Attach T-taps as shown. (Fig. F1)

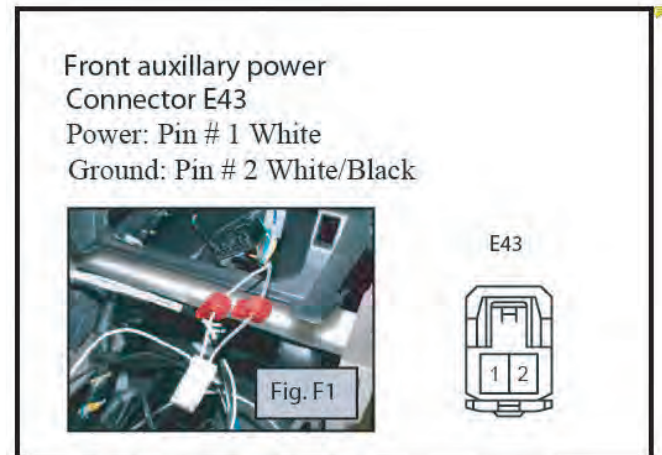

G. Install Main Harness

1. Distribute harness as shown. (Fig. H1)
 - i. PW-Power, two male spade connectors.
 - ii. SW-Switch, Three female spade connectors.
 - iii. CH-Cup Holder, female modular connector.
 - iv. LED-LED Module, (2) female modular connectors.

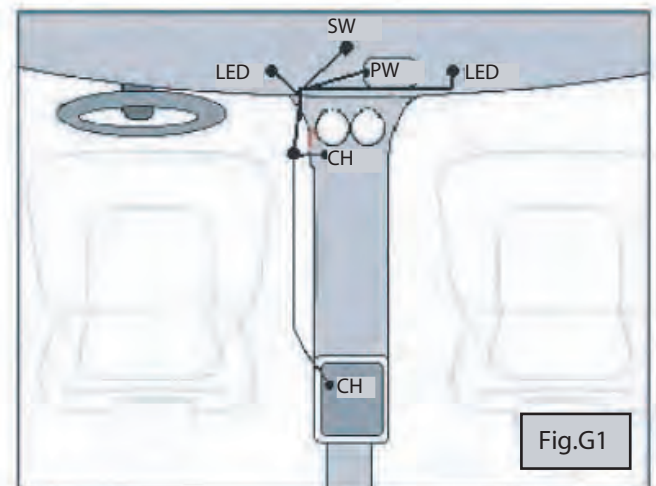

2. Route leads.
 - i. Lay harness in lower half of center console.
 - ii. Route power leads to the auxiliary power outlet tapped earlier.
 - iii. Route LED module leads forward to left and right side of center.
 - iv. Route switch lead so it will be accessible through center dash bezel.



NOTE:

White harness wire attaches to white wire in Connector E43

Black harness wire attaches to white/black wire in Connector E43

H. Install Light Guide

1. Install passenger side light guide. Note Short rod is to be placed on the passenger side.
 - i. Remove under-dash shield, depress tabs drop and slide forward. (Fig. H1)
 - ii. Drill holes in location shown. (Fig. H2)
 - iii. Attach LED module to light guide and orient White stripe towards top.
 - iv. Secure light guide to shield with cable ties, remove excess
 - v. Reinstall under-dash shield.
2. Attach LED module lead to harness. (Fig. H3)
3. Re-install instrument panel bracket cover. (Fig. H4)
4. Install Driver Side Light Guide.
 - i. Attach catamount to "U" nut.
 - ii. Locate right "U" nut, Attach to interior edge of air duct. (Fig. H5)
 - iii. Locate left "U" nut, and attach to plastic tab as shown. (Fig. H6)
 - iv. Attach LED module to light guide.
 - v. Secure light guide to catamounts with plastic tie. (Fig. H7 & H8)
 - vi. Orient light guide with white stripe towards the top.

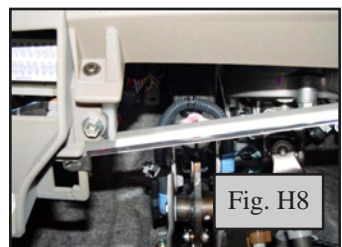
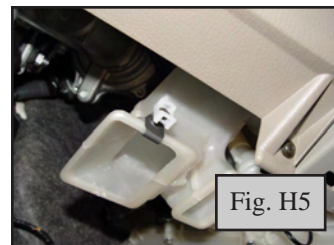
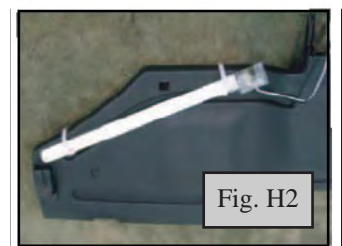
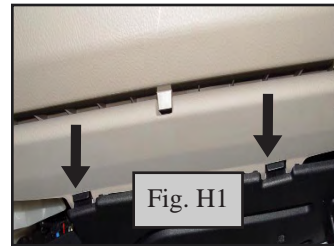

5. Attach LED module lead to harness.
(Fig. H9)
6. Re-install instrument panel bracket cover.
(Fig. H10)

I. Install Switch Assembly

1. Remove knock out from switch panel.
(Fig. I1)
-  2. Drill 1/2" hole 1/2" from top of knock out and center left to right. Use diagonal cutters to remove ribs. (Fig. I2)
3. Clean surface at switch plate location.
4. Insert switch bezel into switch plate and remove tape liner. (Fig. I3)
5. Using the bezel as a guide, install switch plate/bezel into the previously drilled 1/2" hole.
 - i. Align the printing "ILLUMINATION" square to the console. (Fig. I4)
6. Install Sleeve to bezel.

NOTE: If overlay applied remove 1/8" of black end of sleeve with sandpaper.

- i. The "white" ink end of the sleeve must be installed against the console. (Fig. I5)
7. Install switch to bezel as shown. (Fig. I6)
 - i. Turn switch clockwise to tighten.
 - ii. Be careful not to over tighten as this will "over ride" the threads on the switch. If this happens simply retighten being careful not to over tighten.
 - iii. Push button into bezel pressing to engage.
8. Attach switch leads to harness, re-install knock out panel. (Fig. I7)
(A to A,B to B, & C to C)

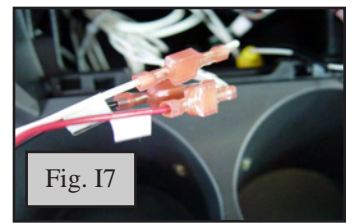
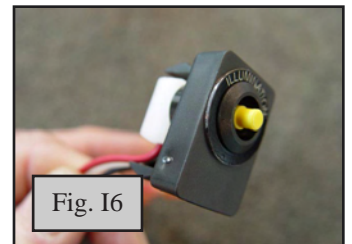
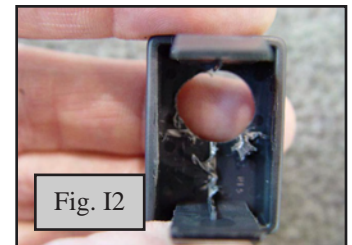
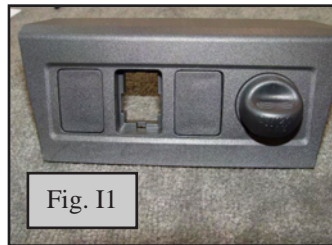

J. Re-install center console.

1. Connect cup holder LEDS to harness.
 (Fig. J1)
2. Re-install cup holder assembly
 - i. Secure front tabs.
 - ii. Re-install (2) screws
3. Re-install shift surround
4. Re-install console garnish
5. Re-install shift knob.

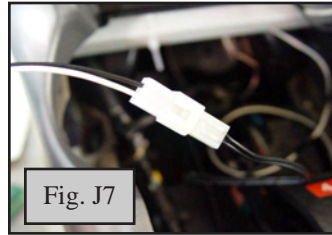

M. Post Installation

1. Reinstall interior.



2. Re-attach negative battery terminal,
torque to 36 inch pounds.

3. Clean Light Guides with window cleaner
and a non-scratch cloth.



4. Cycle test the system with the key in the
ACC or ON position. The cycle may start
from any step below but should cycle in
this order.

i. All lights off.

ii. Cup holder lights on only.

iii. All lights on.

iv. Interior Light on only.

v. Back to step “i”.

5. The switch should be cycled to step “i”
(all lights off) for shipment.

6. Place information card in glove box.

 Section III Functional verification

Check:

Single Unoperational Module

No Operational Modules

Look for:

Full engagement of affected LED module to LED wire harness pigtail connector.

Light guide inserted incorrectly (wrong end)

Full engagement of all LED module to LED wire harness pigtail connectors.

Power connection.

Ground connection

Switch connections

Blown light kit fuse. (2 amp located under center console)

Blown shift console illumination fuse (see vehicle owners manual for amperage and location.)



VEHICLE FUNCTION CHECK

AFTER ALL PANELS, COVERS, AND COMPONENTS HAVE BEEN REINSTALLED, THAT WERE REMOVED, TEST THOROUGHLY, ALL MECHANICAL AND ELECTRICAL COMPONENTS DISCONNECTED AND OR REMOVED FROM THE VEHICLE DURING THE INSTALLATION OF THIS ACCESSORY.

